



# Lifestyle Collection 2021

**marelli**

# Lifestyle Collection 2021

  
RUBELLI  
DOMINIQUE  
Kieffer  
BY RUBELLI

DESIGNERS GUILD

SAHCO

CASAMANCE

ROMO

MISIA  
PARIS

kirkbydesign

DEDAR  
MILANO



ZIMMER+ROHDE

# Indice prodotti

PRODUCT LIST

# Divani

SOFAS

**Alexander**  
PAGE 282 | 288 | 296



**Andy**  
PAGE 8 | 16



**Atacama**  
PAGE 318



**Clipper**  
PAGE 142 | 152 | 158



**Clipper Low**  
PAGE 170



**Gary**  
PAGE 66 | 76 | 86 | 96 | 108



**Gordon**  
PAGE 224 | 236



**Loft**  
PAGE 48 | 62



**Matheus**  
PAGE 186 | 192



**Moon**  
PAGE 8 | 16 | 276



**Nest**  
PAGE 257



**Noah**  
PAGE 116 | 126 | 136



**Sign**  
PAGE 28 | 44



**Slide**  
PAGE 216



# Sedie e poltrone

CHAIRS AND ARMCHAIRS

**Chia**  
PAGE 108-200



**Joy**  
PAGE 158



**Grace**  
PAGE 164



**Brera**  
PAGE 8-66-126-142



**Paris**  
PAGE 96 | 200 | 304



**Megan**  
PAGE 208



**Sign**  
PAGE 276



**Clipper**  
PAGE 236 | 288



**Clipper Chair**  
PAGE 176 | 266



**Moon**  
PAGE 76



**Nest**  
PAGE 48 | 224 | 257 | 282



**Noah**  
PAGE 117



# Tavoli da Pranzo

DINING TABLES

**Anderson**  
PAGE 266



**Break Dining Table**  
PAGE 164



**Hebo**  
PAGE 304



**Tatlin**  
PAGE 200 | 208



**Twig**  
PAGE 176



**Self**



**Xela**  
PAGE 322



**Lobel Bookshelf**  
PAGE 318



**Kyoto**  
PAGE 208



# Librerie, Madie e Credenze

BOOKSHELVES, SIDEBOARDS AND CUPBOARDS

# Tavolini

COFFEE TABLES

**Atene**  
PAGE 44 | 48 | 76 | 116 | 192  
224 | 276 | 282 | 296



**Break**  
PAGE 28 | 126 | 288



**Cassiopea**  
PAGE 257 | 288



**Clip**  
PAGE 8 | 66 | 116 | 126 | 17  
216 | 236 | 244 | 250 | 318



**Dune**  
PAGE 36



**Elle**  
PAGE 28 | 108



**Frame**  
PAGE 66 | 250



**Kyoto**  
PAGE 28 | 62 | 170 | 192 | 296



**Mini**  
PAGE 186



**Tab**  
PAGE 8-158 | 186



**Tatlin**  
PAGE 66 | 126



**Thor**  
PAGE 8 | 16 | 62 | 86 | 96 | 170  
186 | 192 | 216 | 288



**Twig**  
PAGE 8 | 16 | 108 | 216 | 236 | 257



**Wave**  
PAGE 76 | 86 | 96 | 126  
142 | 152 | 296





**ANDY composition** cm300x300 Fabric: cat. F art. Misia Aime col. M188 319 Terre di Siena | Base: OPM17 bronze metal **Cushions:** 2 x 9CU104 cm60x60, 2 x 9CU105 cm50x50 Fabric: cat. F art. Misia Aime col. M188 319 Terre di Siena | 1 x 9CU104 cm60x60, 1x 9CU105 cm50x50 Fabric: cat. F art. Misia Aime col. M188 420 Cuivre **TAB coffee table** 7TAB124 øcm125x36h Base: OPM18 anodyc bronze painted metal | Upper top: OPV9 chrome back-painted bronze glass matt | Lower top: OPV9 chrome back-painted bronze glass shiny **BRERA armchair** 9BRE106 cm80x82x101h Fabric: cat. F art. Misia Aime col. M188 420 Cuivre | Base: OPM15 antique gold brushed metal **CLIP side table** 7CL121 øcm60x40h Base: OPM17 bronze metal | Top: OPV9 chrome back painted bronze glass

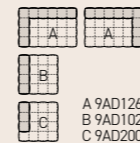

**marelli**



Details of **ANDY sofa TAB coffee table** 7TAB124 øcm125x36h Base: OPM18 anodyc bronze painted metal | Upper top: OPV9 chrome back-painted bronze glass matt | Lower top: OPV9 chrome back-painted bronze glass shiny **CLIP side table** 7CL121 øcm60x40h Base: OPM17 bronze metal | Top: OPV9 chrome back painted bronze glass



**CLIP side table** 7CL121 øcm60x40h Base: OPM17 bronze metal | Top: OPV9 chrome back painted bronze glass



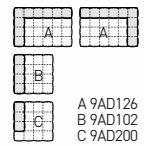

A 9AD126  
B 9AD102  
C 9AD200

**ANDY composition** cm300x300 Fabric: cat. F art. Misia Aime col. M188 319 Terre di Siena | Base: OPM17 bronze metal **Cushions:** 2 x 9CU104 cm60x60, 2 x 9CU105 cm50x50 Fabric: cat. F art. Misia Aime col. M188 319 Terre di Siena | 1 x 9CU104 cm60x60, 1x 9CU105 cm50x50 Fabric: cat. F art. Misia Aime col. M188 420 Cuivre  
**CLIP coffee table** 7CL118 øcm40x50h OPM15 antique gold brushed metal **TWIG coffee table** 7TG104 cm120x71x35h Base: OPP15 Covelano white marble | Top: OPM14 shiny black chrome metal



**ANDY sofa composition** cm300x100x65h Fabric: cat. F art. Misia Aime col. M188 319 Terre di Siena | Base: OPM17 bronze metal **Cushions:** 1 x 9CU104 cm60x60, 2 x 9CU105 cm50x50 Fabric: cat. F art. Misia Aime col. M188 319 Terre di Siena | 1 x 9CU105 cm50x50 Fabric: cat. H art. Casamance Primaute col. 4098-10234 Acier **MOON ottoman** 9MN102 øcm60x40h Fabric: cat. H art. Casamance Nemesia col. 4320 0157 | Base: OPM15 antique gold brushed metal **TWIG coffee table** 7TG103 øcm100x35h Base: OPM16 shiny brass chrome metal | Top: OPP7 Calacatta gold marble **CLIP side table** 7CL117 øcm40x40h OPM15 antique gold brushed metal **THOR side table** 7TH104 cm50x50x50h OPP16 Sahara noir marble **FRAME console** 7FR130 cm200x40x70h Base: OPM15 antique gold brushed metal | Top: OPP7 Calacatta gold marble



A 9AD126

**marelli**



**THOR side table** 7TH104 cm50x50x50h 7TH102 cm100x100x19h OPP16 Sahara noir marble



Brera | Elle | Clip

**BRERA armchairs** 9BRE106 cm80x82x101h Fabric: cat. H art. Rubelli Spritz col. 06 ebano | Base: OPM15 antique gold brushed metal **ELLE coffee tables** 7EL109 cm60x60x27h, 7EL107 cm50x50x43h OPM15 antique gold brushed metal

**marelli**





**BRERA armchair** 9BRE106 cm80x82x101h Fabric: cat. F art. Misa Aime col. M188 420 Cuivre | Base: OPM15 antique gold brushed metal **CLIP side table** 7CL121  
øcm60x40h Base: OPM17 bronze metal | Top: OPV9 chrome back painted bronze glass



**BRERA swivel armchair** 9BRE104 cm80x82x101h Fabric: cat. F art. Misa Aime col. M188 420 Cuivre | Swivel base: OPM18 anodyc bronze metal **CLIP side tables** 7CL117 øcm40x40h, 7CL118 øcm40x50h OPM17 bronze metal





Sign | Kyoto | Elle | Break

**SIGN sofa** 9SI212 cm180x75x75h Fabric: cat. F art. Misia Aime col. M188 613 Seichelles | Base: OPM15 antique gold brushed metal **SIGN armchairs** 9SI112 cm83x75x75h Fabric: cat. F art. Misia Aime col. M188 705 Mordorè | Base: OPM15 antique gold brushed metal **KYOTO coffee tables** 7KY101 øcm40x48h, 7KY109 øcm100x38h Base: OPM16 shiny brass chrome metal | Top: OPP2 Marquinia black marble **ELLE side table** 7EL107 cm50x50x43h OPM16 shiny brass chrome metal

**marelli**





**SIGN sofa** 9SI212 cm180x75x75h Fabric: cat. F art. Misia Aime col. M188 613 Seichelles | Base: OPM15 antique gold brushed metal **SIGN armchairs** 9SI112 cm83x75x75h Fabric: cat. F art. Misia Aime col. M188 705 Mordorè | Base: OPM15 antique gold brushed metal **KYOTO coffee tables** 7KY101 øcm40x48h, 7KY109 øcm100x38h Base: OPM16 shiny brass chrome metal | Top: OPP2 Marquinia black marble



**SIGN sofa** 9SI212 cm180x75x75h Fabric: cat. F art. Misia Aime col. M188 613 Seichelles | Base: OPM15 antique gold brushed metal **SIGN armchairs** 9SI112 cm83x75x75h Fabric: cat. F art. Misia Aime col. M188 705 Mordorè | Base: OPM15 antique gold brushed metal **ELLE side tables** 7EL109 cm60x60x27h, 7EL107 cm50x50x43h OPM16 shiny brass chrome metal **KYOTO coffee tables** 7KY101 øcm40x48h, 7KY103 øcm50x38h, 7KY109 øcm100x38h | Base: OPM16 shiny brass chrome metal | Top: OPP2 Marquinia black marble



Detail of metal leg in OPM15 antique gold brushed metal

> **SIGN sofa** 9SI212 cm180x75x75h Fabric: cat. F art. Misia Aime col. M188 613 Seichelles | Base: OPM15 antique gold brushed metal **BREAK side tables** 7BR117 øcm40x45h, 7BR118 øcm60x36h | Base: OPM16 shiny brass chrome metal | Top: OPV12 transparent bronze glass





Sign | Twig | Clip | Dune | Atene

**SIGN sofa and armchairs** 9SI102 cm83x75x75h, 9SI201 cm160x75x75h Fabric: cat. G art. Orsetto col. 01/1 | Wooden base: OPR15 moka matt stained oak **DUNE coffee table** 7DU103 cm130x80x37h Base: OPR15 moka matt stained oak and OPM15 antique gold brushed metal | Top: OPP13 Velvet brown marble **CLIP side table** 7CL118 øcm40x50h OPM15 antique gold brushed metal **TWIG side table** 7TG101 øcm50x50h Base: OPM16 shiny brass chrome metal | Top: OPP7 Calacatta gold marble

**marelli**



**SIGN armchair** 9SI102 cm83x75x75h Fabric: cat. G art. Orsetto col. 01/1 Base: OPR15 moka matt stained oak **TWIG coffee table** 7TG101 øcm50x50h Base: OPM16 shiny brass chrome metal | Top: OPP7 Calacatta gold marble



**SIGN sofa** 9SI201 cm160x75x75h Fabric: cat. G art. Orsetto col. 01/1 Base: OPR15 moka matt stained oak **TWIG coffee table** 7TG101 øcm50x50h Base: OPM16 shiny brass chrome metal | Top: OPP7 Calacatta gold marble





**SIGN swivel armchairs** 9SI101 cm83x75x75h Fabric: cat. F art. Misia Aime col. M188 705 mordoré | Base: OPM15 antique gold brushed metal **KYOTO coffee table** 7KY103  
øcm50x38h Base: OPM16 shiny brass chrome metal | Top: OPP2 Marquinia black marble







**SIGN armchairs** 9SI112 cm83x75x75h Fabric: cat. D/E art. Delius Opera 1551 Base: OPM16 shiny brass chrome metal **ATENE coffee table** 7AT105 øcm120x30h Base: OPM16 shiny brass chrome metal | Top: OPP21 Calacatta violet marble



**LOFT 100 composition** cm445x315 with OPR15 moka matt low console Fabric: cat. D/E art. Lucinasco col. 02 | Base D OPM18 anodyc bronze painted metal  
**Extra cushions:** 2 x 9CU104 cm60x60, 2 x 9CU106 cm45x45 Fabric: cat. D/E art. Lucinasco col. 02 | 2 x 9CU105 cm50x50 Fabric: cat. H art. Casamance Fifties 4769-0377 | 1 x 9CU105 cm50x50 Fabric: cat. H art. Sahco Avalon 2 col. 034 **ATENE coffee tables** 7AT104 øcm100x30h, 7AT101 øcm50x40h, 7AT103 øcm80x30h  
 Base: OPM14 shiny black chrome metal | Top: OPP20 Arabescato Vagli grey marble **NEST armchair** 9NE101 cm73x80x90h Fabric: cat. H art. Sahco Avalon 2 col. 034 | Base: OPM14 shiny black chrome metal

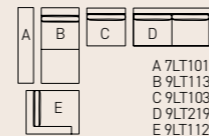

A 7LT101  
 B 9LT113  
 C 9LT103  
 D 9LT219  
 E 9LT112

**marelli**

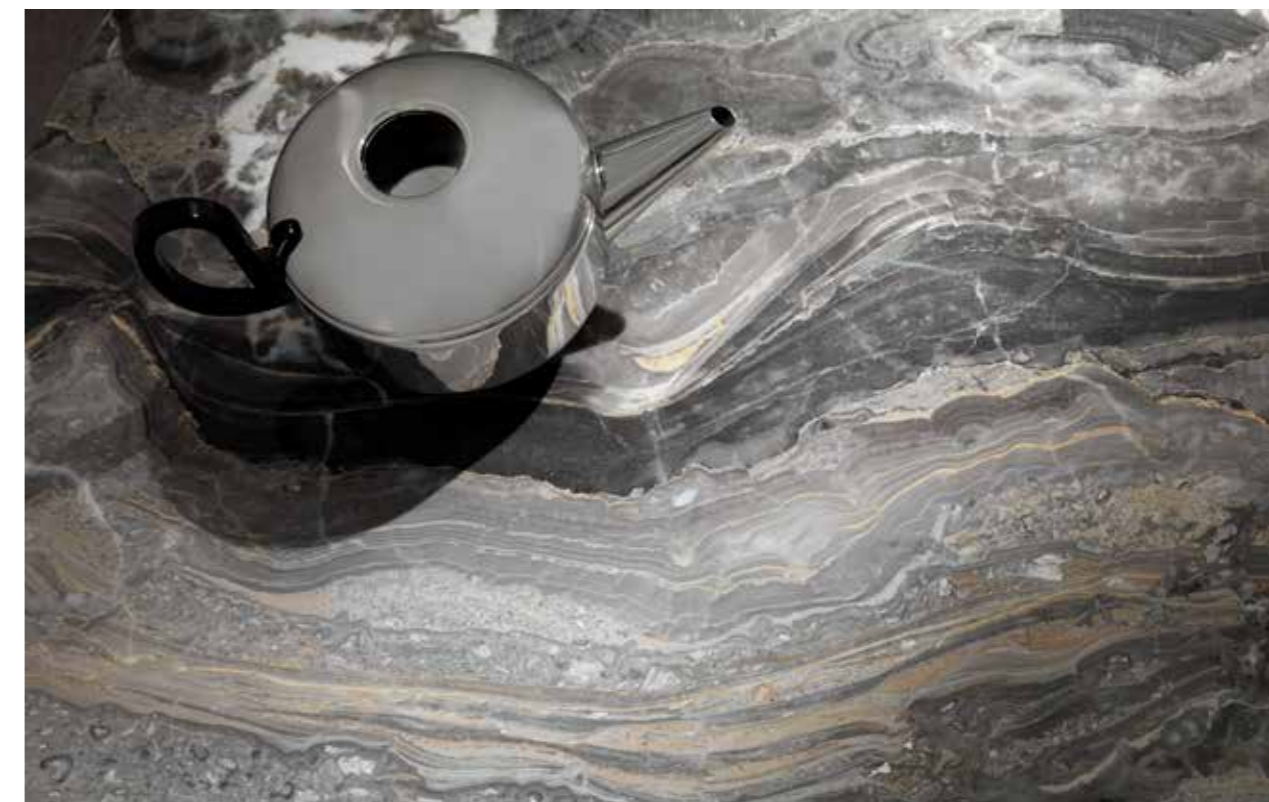

**ATENE coffee tables** 7AT104 øcm100x30h, 7AT101 øcm50x40h, 7AT103 øcm80x30h Base: OPM14 shiny black chrome metal | Top: OPP20 Arabescato Vagli grey marble





Detail of **LOFT 100 composition** in fabric cat. D/E art. Lucinasco 02 with OPR15 moka matt low console and NEST armchair 9NE101 cm73x80x90h in fabric cat. H art. Sahco Avalon 2 col. 034 with OPM14 shiny black chrome base



**NEST armchair** 9NE101 cm73x80x90h Fabric: cat. F art. Sahco Avalon 2 col. 034 | Base: OPM14 shiny black chrome metal **ATENE coffee table** 7AT103 øcm80x30h  
Base: OPM14 shiny black chrome metal | Top: OPP20 Arabescato Vagli grey marble







**ATENE coffee tables** 7AT104 øcm100x30h, 7AT101 øcm50x40h, 7AT103 øcm80x30h Base: OPM14 shiny black chrome metal | Top: OPP20 Arabescato Vagli grey marble







**LOFT 100 sofa** 9LT204 cm260x100x90h Fabric: cat. H art. Sahco Avalon 2 col. 038 | Base A: OPM15 antique gold brushed metal **Cushions:** 2 x 9CU104 cm60x60 Fabric: cat. E art. Tortuga col. 18 | 2 x 9CU105 cm50x50 Fabric: cat. H art. Rubelli Vello d'Oro col. 30085 20 muschio **THOR side table** 7TH104 cm50x50x50h OPP16 Sahara noir marble **KYOTO coffee tables** 7KY101 øcm40x48h, 7KY109 øcm100x38h Base: OPM16 shiny brass chrome metal | Top: OPP2 Marquinia black marble



**LOFT 100 sofa** 9LT204 cm260x100x90h Fabric: cat. H art. Sahco Avalon 2 col. 038 | Base A: OPM15 antique gold brushed metal **Cushions:** 1 x 9CU104 cm60x60 Fabric: cat. E art. Tortuga col. 18 | 1 x 9CU105 cm50x50 Fabric: cat. H art. Rubelli Vello d'Oro col. 30085 20 muschio **THOR side table** 7TH104 cm50x50x50h OPP16 Sahara noir marble



**GARY composition** Fabric: cat. H art. Rubelli Spritz col. 12 Tortora **Cushions:** 2 x 9CU104 cm60x60 in Spritz col. 12 Tortora | 1 x 9CU105 cm50x50 in Spritz col. 12 Tortora | 1 x 9CU104 cm60x60 in Spritz col. 24 Reseda | 1 x 9CU105 cm50x50 in cat. F art. Misia Aime col. M188 319 terre di Siena **BRERA armchair** with low back and metal base 9BRE103 cm80x82x77h Fabric: cat. H art. Rubelli Spritz col. 24 Reseda | Base: OPM15 antique gold brushed metal **FRAME coffee table** 7FR121 øcm100x28h Base: OPM16 shiny brass chrome metal | Top: OPP12 Guatemala Green marble **CLIP side table** 7CL117 øcm40x40h OPM16 shiny brass chrome metal **TATLIN side table** 7TAT101 øcm40x51h Base: OPM15 antique gold brushed metal | Top: OPP12 Guatemala Green marble

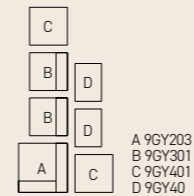

**marelli**



**GARY composition** Fabric: cat. H art. Rubelli Spritz col. 12 Tortora **Cushions:** 2 x 9CU104 cm60x60 in Spritz col. 12 Tortora | 1 x 9CU105 cm50x50 in Spritz col. 12 Tortora | 1 x 9CU104 cm60x60 in Spritz col. 24 Reseda | 1 x 9CU105 cm50x50 in cat. F art. Misia Aime col. M188 319 terre di Siena **BRERA armchair** with low back and metal base 9BRE103 cm80x82x77h Fabric: cat. H art. Rubelli Spritz col. 24 Reseda | Base: OPM15 antique gold brushed metal **FRAME coffee table** 7FR121 øcm100x28h Base: OPM16 shiny brass chrome metal | Top: OPP12 Guatemala Green marble **CLIP side table** 7CL117 ø 40x40h OPM16 shiny brass chrome metal **TATLIN side table** 7TAT101 øcm40x51h Base: OPM15 antique gold brushed metal | Top: OPP12 Guatemala Green marble

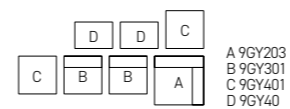



**BRERA armchair** with low back and metal base 9BRE103 cm80x82x77h Fabric: cat. H art. Rubelli Spritz col. 24 Reseda | Base: OPM15 antique gold brushed metal  
**FRAME coffee table** 7FR121 øcm100x28h Base: OPM16 shiny brass chrome metal | Top: OPP12 Guatemala Green marble



**TATLIN side tables** 7TAT101 øcm40x51h, 7TAT104 øcm100x41h Base: OPM15 antique gold brushed metal | Top: OPP12 Guatemala Green marble.  
> Detail of **GARY composition** in fabric cat. H art. Rubelli Spritz col 12 Tortora and **TATLIN side table**



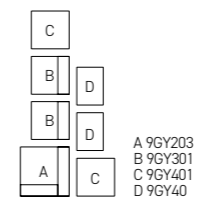

**FRAME coffee table** 7FR121 øcm100x28h Base: OPM16 shiny brass chrome metal | Top: OPP12 Guatemala Green marble **CLIP side table** 7CL117 øcm40x40h OPM16 shiny brass chrome metal



**GARY composition** cm460x330 Fabric: cat. C art. Koala col. 118 **Cushions:** 6 x 9GY103 cm60x60, 1 x 9GY102 cm45x45 Fabric: cat. C art. Koala col. 118 | 2 x 9GY102 cm45x45 Fabric: cat. E art. Delius Opera col. 6550 **ATENE coffee tables** 7AT105 øcm120x30h, 7AT102 øcm50x50h Base: OPM16 shiny brass chrome marble | Top: OPP21 Calacatta violet marble

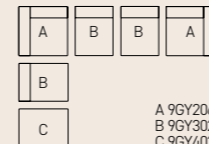

A 9GY206  
B 9GY302  
C 9GY402

**marelli**





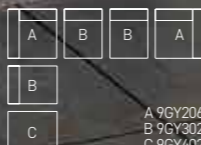

**GARY composition** cm460x330 Fabric: cat. C art. Koala col. 118 **Cushions:** 6 x 9GY103 cm60x60, 1 x 9GY102 cm45x45 Fabric: cat. C art. Koala col. 118 | 2 x 9GY102 cm45x45 Fabric: cat. E art. Delius Opera col. 6550 **MOON armchair** 9MN101 cm98x90x76h Fabric: cat. C art. Koala col. 115 | Base: OPM6 RAL 9017 traffic black painted metal **ATENE coffee tables** 7AT105 øcm120x30h, 7AT102 øcm50x50h Base: OPM16 shiny brass chrome marble | Top: OPP21 Calacatta violet marble



**MOON armchairs** 9MN101 cm98x90x76h Fabric: cat. C art. Koala col. 115 | Base: OPM6 RAL 9017 traffic black painted metal **WAVE side table** 7WA101 ø 50x47h  
Base: OPM20 Délabré brass brushed metal | Top: OPP7 Calacatta gold marble





**GARY FOAM composition** cm334x435 Foam version Fabric: cat. G art. Kieffer by Rubelli Velour Soleil col. 17189/012 Mastic with central seat element 9GZT403 in leather cat. Lusso art. Nabuk C/3409 Talpa **Cushions:** 2 x 9CUT106 cm45x45 Leather: cat. Lusso art. Nabuk C/3409 Talpa | 2 x 9CUT104 cm60x60 Fabric: cat. G art. Kieffer by Rubelli Velour Soleil col. 17189/012 Mastic | 1 x 9CU106 cm45x45, 1 x 9CU104 cm60x60 Fabric: cat. H art. Misia M261-801 Ivory | 2 x 9CU105 cm50x50 Fabric: cat. H art. Misia M260-701 Sepia **WAVE coffee tables** 7WA101 øcm50x47h, 7WA104 øcm120x27h Base: OPM20 Délabré brass brushed metal | Top: OPP7 Calacatta gold marble 7WA112 øcm60x37h Base: OPM20 Délabré brass brushed metal | Top: OPV6 RAL 1019 grey beige back-painted glass **THOR side table** 7TH102 cm100x100x19h OPP7 Calacatta gold marble

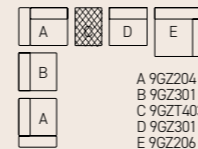

**marelli**





**GARY FOAM composition** cm334x435 Foam version Fabric: cat. G art. Kieffer by Rubelli Velour Soleil col. 17189/012 Mastic with central seat element 9GZT403 in leather cat. Lusso art. Nabuk C/3409 Talpa **Cushions:** 2 x 9CUT106 cm45x45 Leather: cat. Lusso art. Nabuk C/3409 Talpa | 2 x 9CUT104 cm60x60 Fabric: cat. G art. Kieffer by Rubelli Velour Soleil col. 17189/012 Mastic | 1 x 9CU106 cm45x45, 1 x 9CU104 cm60x60 Fabric: cat. H art. Misia M261-801 Ivory | 2 x 9CU105 cm50x50 Fabric: cat. H art. Misia M260-701 Sepia **WAVE coffee tables** 7WA101 øcm50x47h, 7WA104 øcm120x27h Base: OPM20 Délabré brass brushed metal | Top: OPP7 Calacatta gold marble 7WA112 øcm60x37h Base: OPM20 Délabré brass brushed metal | Top: OPV6 RAL 1019 grey beige back-painted glass



**WAVE coffee tables** 7WA101  $\varnothing$ cm50x47h, 7WA102  $\varnothing$ cm60x37h, 7WA104  $\varnothing$ cm120x27h Base: OPM20 Délabré brass brushed metal | Top: OPP7 Calacatta gold marble, 7WA112  $\varnothing$ cm60x37h Base: OPM20 Délabré brass brushed metal | Top: OPV6 RAL 1019 grey beige back-painted glass







Details of **GARY FOAM composition** cm334x435 Foam version Fabric: cat. G art. Kieffer by Rubelli Velour Soleil col. 17189/012 Mastic with central seat element 9GZT403 in leather cat. Lusso art. Nabuk C/3409 Talpa



**GARY FOAM composition** cm334 – Foam version Fabric: cat. G art. Kieffer by Rubelli Velour Soleil col. 17189/012 Mastic **Cushions:** 1 x 9CUT104 cm60x60 Fabric: cat. G art. Kieffer by Rubelli Velour Soleil col. 17189/012 Mastic | 1 x 9CUT106 cm45x45, 1 x 9CU104 cm60x60 Fabric: cat. H art. Misia M261-801 Ivory | 2 x 9CU105 cm50x50 Fabric: cat. H art. Misia M260-701 Sepia | 1 x 9CUT106 cm45x45 Leather: cat. Lusso art. Nabuk C/3409 Talpa **PARIS armchairs** 9PAR201X cm73x75x76h Fabric: cat. H art. Rubelli Vello d'oro col. 15 pavone with base covered in fabric **WAVE coffee tables** 7WA104 øcm120x27h Base: OPM20 Délabré brass brushed metal | Top: OPP7 Calacatta gold marble | 7WA112 øcm60x37h Base: OPM20 Délabré brass brushed metal | Top: OPV6 RAL 1019 grey beige back-painted glass **THOR side table** 7TH104 cm50x50x50h OPP13 Velvet brown marble

A	B	A
---	---	---

A 9GZ204  
B 9GZ301

**marelli**



**THOR side tables** 7TH102 cm100x100x19h OPP7 Calacatta gold marble 7TH104 cm50x50x50h OPP13 Velvet brown marble



**PARIS armchairs** 9PAR201X cm73x75x76h Fabric: cat. H art. Rubelli Vello d'oro col. 15 pavone with base covered in fabric





**THOR side table** 7TH104 cm50x50x50h OPP13 Velvet brown marble



Gary Foam | Twig | Chia | Elle

**GARY FOAM composition** cm260x100x66h Fabric: cat. F art. Misia Aime M188 916 Blue Misia **Cushions:** 1 x 9GY103 cm60x60 in M188 916 Blue Misia | 1 x 9GY102 cm45x45 in M188 108 Gris de Mauvre **TWIG coffee table** 7TG104 cm120x71x35h Base: OPM16 shiny brass chrome metal | Top: OPP9 Black & Gold marble **ELLE side tables** 7EL107 cm50x50x43h, 7EL109 cm60x60x27h OPM16 shiny brass gold metal **TWIG dining table** 7TG139 øcm120x74h Base: OPM16 shiny brass chrome metal | Top: OPP9 Black & Gold marble **CHIA chairs** 9CHI104 cm58x53x77h | Outside: Leather cat. Lusso art. Brevia col. P4201 nero | Inside: Fabric cat. F art. Misia Aime M188 916 Blue Misia | Base: OPM6 RAL 9017 traffic black painted metal

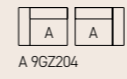

marelli







**GARY FOAM composition** cm260x100x66h Fabric: cat. F art. Misia Aime M188 916 Blue Misia **Cushions:** 1 x 9GY103 cm60x60 in M188 916 Blue Misia | 1 x 9GY102 cm45x45 in M188 108 Gris de Mauvre **TWIG coffee table** 7TG104 cm120x71x35h Base: OPM16 shiny brass chrome metal | Top: OPP9 Black & Gold marble **ELLE side tables** 7EL107 cm50x50x43h, 7EL109 cm60x60x27h OPM16 shiny brass gold metal



**TWIG dining table** 7TG139 øcm120x74h Base: OPM16 shiny brass chrome metal | Top: OPP9 Black & Gold marble **CHIA chairs** 9CHI104 cm58x53x77h | Outside: Leather cat. Lusso art. Brevia col. P4201 nero | Inside: Fabric cat. F art. Misia Aime M188 916 Blue Misia | Base: OPM6 RAL 9017 traffic black painted metal



**TWIG dining table** 7TG139 øcm120x74h Base: OPM16 shiny brass chrome metal | Top: OPP9 Black & Gold marble **CHIA chairs** 9CHI104 cm58x53x77h | Outside: Leather cat. Lusso art. Brevia col. P4201 nero | Inside: Fabric cat. F art. Misia Aime M188 916 Blue Misia | Base: OPM6 RAL 9017 traffic black painted metal



Noah | Atene | Clip

**NOAH armchairs** 9NH101 cm90x90x76,5h Fabric: cat. H art. Designers Guild Glenville F1872-36 Honey **NOAH Curved Sofa** 9NH301 cm250x100x80h Fabric: cat. G art. Orsetto col. 01/2 **Extra cushions:** 2 x 9CU106 cm45x45 Fabric: cat. G art. Orsetto col. 01/2 | 1 x 9CU106 cm45x45 Fabric: cat. H art. Designers Guild Glenville F1872-36 Honey **CLIP coffee table** 7CL117 øcm40x40h OPM16 shiny brass chrome metal **ATENE coffee table** 7AT105 øcm120x30h Base: OPM16 shiny brass chrome metal | Top: OPP7 Calacatta gold marble



**NOAH armchairs** 9NH101 cm90x90x76,5h Fabric: cat. H art. Designers Guild Glenville F1872-36 Honey **NOAH Curved Sofa** 9NH301 cm250x100x80h Fabric: cat. G art. Orsetto col. 01/2 **Extra cushions:** 2 x 9CU106 cm45x45 Fabric: cat. G art. Orsetto col. 01/2 | 1 x 9CU106 cm45x45 Fabric: cat. H art. Designers Guild Glenville F1872-36 Honey **CLIP coffee table** 7CL117 øcm40x40h OPM16 shiny brass chrome metal **ATENE coffee table** 7AT105 øcm120x30h Base: OPM16 shiny brass chrome metal | Top: OPP7 Calacatta gold marble





**NOAH armchairs** 9NH101 cm90x90x76,5h Fabric: cat. H art. Designers Guild Glenville F1872-36 Honey **NOAH Curved Sofa** 9NH301 cm250x100x80h Fabric: cat. G art. Orsetto col. 01/2 **Extra cushions:** 2 x 9CU106 cm45x45 Fabric: cat. G art. Orsetto col. 01/2 | 1 x 9CU106 cm45x45 Fabric: cat. H art. Designers Guild Glenville F1872-36 Honey **CLIP coffee table** 7CL117 øcm40x40h OPM16 shiny brass chrome metal **ATENE coffee table** 7AT105 øcm120x30h Base: OPM16 shiny brass chrome metal | Top: OPP7 Calacatta gold marble



**NOAH armchair** 9NH101 cm90x90x76,5h Fabric: cat. H art. Designers Guild Glenville F1872-36 Honey **NOAH Curved Sofa** 9NH301 cm250x100x80h Fabric: cat. G art. Orsetto col. 01/2 **Extra cushions:** 2 x 9CU106 cm45x45 Fabric: cat. G art. Orsetto col. 01/2 | 1 x 9CU106 cm45x45 Fabric: cat. H art. Designers Guild Glenville F1872-36 Honey **ATENE coffee table** 7AT105 øcm120x30h Base: OPM16 shiny brass chrome metal | Top: OPP7 Calacatta gold marble



**NOAH armchairs** 9NH101 cm90x90x76,5h Fabric: cat. H art. Designers Guild Glenville F1872-36 Honey **ATENE coffee table** 7AT105 øcm120x30h Base: OPM16 shiny brass chrome metal | Top: OPP7 Calacatta gold marble





Noah | Wave

**NOAH sofa** 9NH202 cm250x100x80h Fabric: cat. H art. Designers Guild Glenville F1872-19 Ocean **Extra cushions:** 2 x 9CU106 cm45x45 Fabric: cat. H art. Designers Guild Glenville F1872-19 Ocean | 1 x 9CU106 cm45x45 Fabric: cat. H art. Designers Guild Glenville F1872-43 Cirrus **NOAH chaise longue** 9NH102 cm220x100x80h Fabric: cat. H art. Designers Guild Glenville F1872-43 Cirrus **Extra cushions:** 1 x 9CU106 cm45x45 Fabric: cat. H art. Designers Guild Glenville F1872-19 Ocean | 1 x 9CU106 cm45x45 Fabric: cat. H art. Designers Guild Glenville F1872-43 Cirrus **WAVE coffee tables** 7WA104 øcm120x27h, 7WA102 øcm60x37h, 7WA191 øcm50x47h Base: OPM19 Délabré pewter brushed metal | Top: OPP20 Arabescato orobico grey marble



**NOAH sofa** 9NH202 cm250x100x80h Fabric: cat. H art. Designers Guild Glenville F1872-19 Ocean **Extra cushions:** 1 x 9CU106 cm45x45 Fabric: cat. H art. Designers Guild Glenville F1872-19 Ocean **WAVE coffee tables** 7WA104 øcm120x27h, 7WA102 øcm60x37h, 7WA191 øcm50x47h Base: OPM19 Délabré pewter brushed metal | Top: OPP20 Arabescato orobico grey marble



**NOAH chaise** longue 9NH102 cm220x100x80h Fabric: cat. H art. Designers Guild Glenville F1872-43 Cirrus **Extra cushions:** 1 x 9CU106 cm45x45 Fabric: cat. H art. Designers Guild Glenville F1872-19 Ocean | 1 x 9CU106 cm45x45 Fabric: cat. H art. Designers Guild Glenville F1872-43 Cirrus **WAVE coffee table** 7WA191 øcm50x47h Base: OPM19 Délabré pewter brushed metal | Top: OPP20 Arabescato orobico grey marble



**NOAH sofa** 9NH202 cm250x100x80h Fabric: cat. H art. Designers Guild Glenville F1872-19 Ocean **Extra cushions:** 2 x 9CU106 cm45x45 Fabric: cat. H art. Designers Guild Glenville F1872-19 Ocean | 1 x 9CU106 cm45x45 Fabric: cat. H art. Designers Guild Glenville F1872-43 Cirrus **NOAH chaise longue** 9NH102 cm220x100x80h Fabric: cat. H art. Designers Guild Glenville F1872-43 Cirrus **Extra cushions:** 1 x 9CU106 cm45x45 Fabric: cat. H art. Designers Guild Glenville F1872-19 Ocean | 1 x 9CU106 cm45x45 Fabric: cat. H art. Designers Guild Glenville F1872-43 Cirrus **WAVE coffee tables** 7WA104 øcm120x27h, 7WA102 øcm60x37h, 7WA191 øcm50x47h Base: OPM19 Délabré pewter brushed metal | Top: OPP20 Arabescato orobico grey marble



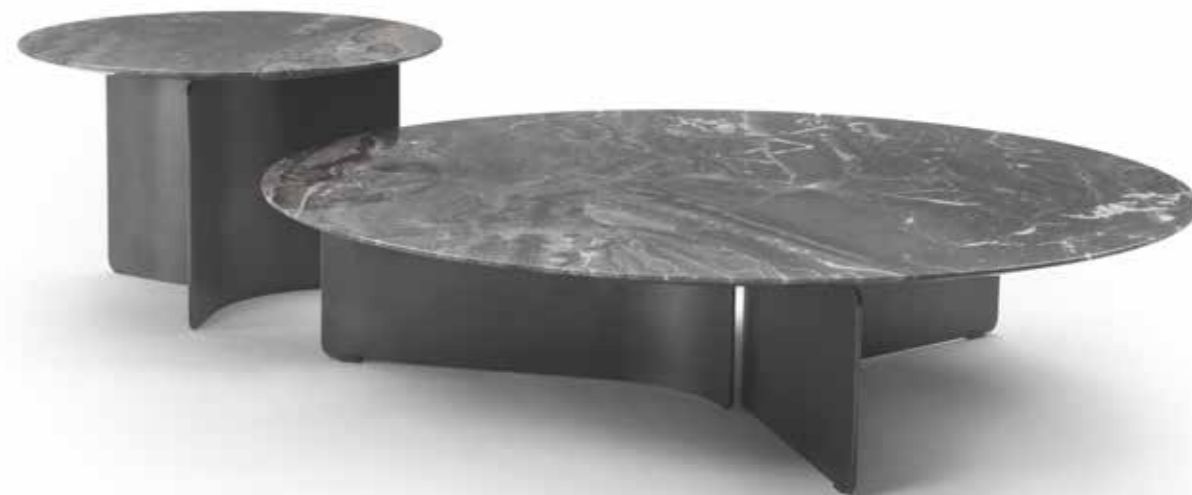

**NOAH sofa** 9NH202 cm250x100x80h Fabric: cat. H art. Designers Guild Glenville F1872-19 Ocean **WAVE coffee tables** 7WA104 øcm120x27h, 7WA102 øcm60x37h, 7WA191 øcm50x47h Base: OPM19 Délabré pewter brushed metal | Top: OPP20 Arabescato orobico grey marble



Noah | Brera | Clip | Break | Tatlin

**NOAH sofa** 9NH202 cm250x100x80h FABric: cat. G art. Orsetto col. 01/1 **Extra cushions:** 2 x 9CU106 cm45x45 Fabric: cat. H art. Designers Guild Glenville F1872-36  
**Honey BRERA armchair** 9BRE105 cm80x82x101h FABric: cat. G art. Orsetto col. 01/1 | Base: OPR15 moka matt stained oak **BREAK coffee table** 7BR118 øcm60x36h  
 Base: OPM16 shiny brass chrome metal | Top: OPV12 transparent bronze glass **CLIP coffee table** 7CL118 øcm40x50h OPM16 shiny brass chrome metal **TATLIN side table** 7TAT104 øcm100x41h Base: OPM16 shiny brass chrome metal | Top: OPP7 Calacatta gold marble



**CLIP coffee tables** 7CL117 øcm40x40h, 7CL118 øcm40x50h OPM16 shiny brass chrome metal **BREAK coffee table** 7BR118 øcm60x36h Base: OPM16 shiny brass chrome metal | Top: OPV12 Transparent bronze glass > **BRERA armchair** 9BRE105 cm80x82x101h Fabric: cat. G art. Orsetto col. 01/1 Base: OPR15 moka matt stained oak





< **BRERA armchair** 9BRE105 cm80x82x101h Fabric: cat. G art. Orsetto col. 01/1 Base: OPR15 moka matt stained oak **CLIP side table** 7CL117 øcm40x40h OPM16 shiny brass chrome metal





Clipper | Brera | Wave

**CLIPPER composition** cm307x252 Fabric: cat. D/E art. Lucinasco col. 04 Base: OPM14 shiny black chrome metal **Extra cushions:** 2 X 9CU106 cm45x45 in fabric cat. H art. Sahco Avalon 2 col. 07 | 1 x 9CU106 cm45x45 in fabric cat. H art. Sahco Avalon 2 col. 04 | 2 x 9CU104 cm60x60 Fabric: cat. H art. Casamance Autographe 3690 0789 | 1 x 9CU104 cm60x60 Fabric: cat. H art. Dedar Elektra col. T20027/016 Bleu horizon **BRERA swivel armchair** 9BRE101 cm80x82x77h Fabric: cat. H art. Casamance Autographe 3690 0789 Base: OPM18 anodyc bronze painted metal **WAVE coffee tables** 7WA101 øcm50x47h, 7WA102 øcm60x37h, 7WA104 øcm120x27h Base: OPM19 Délabré pewter brushed metal | Top: OPP20 Arabescato orobico grey marble

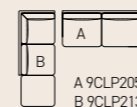

marelli

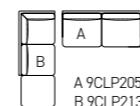

**CLIPPER composition** cm307x252 Fabric: cat. D/E art. Lucinasco col. 04 | Base: OPM14 shiny black chrome metal **Extra cushions:** 2 x 9CU106 cm45x45 Fabric: cat. H art. Sahco Avalon col. 02 | 1 x 9CU106 cm45x45 Fabric: cat. H art. Sahco Avalon col. 04 | 2 x 9CU104 cm60x60 Fabric: cat. H art. Casamance Autographe 3690 0789 | 1 x 9CU104 cm60x60 Fabric: cat. H art. Dedar Elektra col. T20027/016 Bleu horizon **WAVE coffee tables** 7WA101 øcm50x47h, 7WA102 øcm60x37h, 7WA104 øcm120x27h Base: OPM19 Délabré pewter brushed metal | Top: OPP20 Arabescato orobico grey marble



**BRERA swivel armchair** 9BRE101 cm80x82x77h Fabric: cat. H art. Casamance Autographe 3690 0789 Base: OPM18 anodyc bronze painted metal **WAVE coffee table** 7WA101 øcm50x47h Base: OPM19 Délabré pewter brushed metal | Top: OPP20 Arabescato orobico grey marble





**WAVE coffee tables** 7WA101  $\varnothing$ cm50x47h, 7WA102  $\varnothing$ cm60x37h, 7WA104  $\varnothing$ cm120x27h Base: OPM19 Délabré pewter brushed metal | Top: OPP20 Arabescato orobico grey marble





**CLIPPER composition** cm307x252 Fabric: cat. D/E art. Lucinasco col. 04 Base: OPM14 shiny black chrome metal **Extra cushions:** 2 x 9CU106 cm45x45 Fabric: cat. H art. Sahco Avalon col. 07 | 1 x 9CU106 cm45x45 Fabric: cat. H art. Sahco Avalon col. 04 | 2 x 9CU104 cm60x60 Fabric: cat. H art. Dedar Elektra col. T20027/016 Bleu horizon  
**CLIPPER armchairs** 9CLX107 cm70x76x75h Outside: Leather cat. Lusso art. Nabuk col. Navy 3437 | Inside: Fabric cat. D/E art. Dolomite col. 35 | Base: OPM17 bronze metal **WAVE coffee tables** 7WA101 øcm50x47h, 7WA102 øcm60x37h, 7WA104 øcm120x27h Base: OPM19 Délabré pewter brushed metal | Top: OPP20 Arabescato orobico grey marble

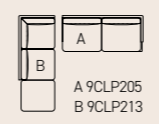

Clipper | Wave

**marelli**



**CLIPPER armchairs** 9CLX107 cm70x76x75h Outside: Leather cat. Lusso art. Nabuk col. Navy 3437 | Inside: Fabric cat. D/E art. Dolomite col. 35 | Base: OPM17 bronze metal **WAVE coffee tables** 7WA101 øcm50x47h, 7WA104 øcm120x27h Base: OPM19 Délabré pewter brushed metal | Top: OPP20 Arabescato orobico grey marble



**CLIPPER armchairs** 9CLX107 cm70x76x75h Outside: Leather cat. Lusso art. Nabuk col. Navy 3437 | Inside: Fabric cat. D/E art. Dolomite col. 35 | Base: OPM17 bronze metal **WAVE coffee tables** 7WA101 øcm50x47h, 7WA104 øcm120x27h Base: OPM19 Délabré pewter brushed metal | Top: OPP20 Arabescato orobico grey marble





Clipper | Joy | Tab

**CLIPPER composition** cm307x212 Fabric: cat. D/E art. Jurga col. 22 Base: OPM15 antique gold brushed metal **Extra cushions:** 1 x 9CU106 cm45x45 Fabric: cat. D/E art. Jurga col. 22 | 1 x 9CU106 cm45x45 Fabric: cat. H art. Casamance Taiga 4594/2359 Ambre | 2 x 9CU106 cm45x45 Fabric: cat. F art. Misia Aime M188 907 Cacao | 1 x 9CU104 cm60x60 Fabric: cat. H art. Rubelli Spritz col. 15 ambra **JOY armchair** 9JY101 cm75x82x99h Leather: cat. Lusso art. Nabuk C3410 wengè | Base A OPM15 antique gold brushed metal **TAB table** 7TAB114 øcm125x36h Base: OPM18 anodyc bronze painted metal | Upper top: OPP3 Emperador brown marble | Lower top: OPV9 chrome back-painted bronze metal

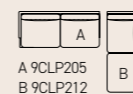

**marelli**



**TAB table** 7TAB114 øcm125x36h Base: OPM18 anodyc bronze painted metal | Upper top: OPP3 Emperador brown marble | Lower top: OPV9 chrome back-painted bronze metal



**JOY wingback chair** 9JY104 cm75x82x99h Leather: cat. Lusso art. Nabuk C3405 tartufo | Base A OPM17 bronze metal **CLIP side table** 7CL117 øcm40x40h OPM15 antique gold brushed metal  
 > **JOY armchair** 9JY101 cm75x82x99h Leather: cat. Lusso art. Nabuk C3410 wengè | Base A OPM15 antique gold brushed metal





Break Dining Table | Grace

**BREAK dining table** 7BR220 øcm190x74h Base: OPM18 anodyc bronze painted metal | Top: OPP1 Carrara white marble **GRACE chairs** 9GR101 cm53x56x91h, 9GR102 cm56x56x91h Fabric: cat. H art. Sahco Kent col. 3 | Base: OPR15 moka matt stained oak







**BREAK dining table** 7BR220  $\varnothing$ cm190x74h Base: OPM18 anodyc bronze painted metal | Top: OPP1 Carrara white marble **GRACE chairs** 9GR101 cm53x56x91h, 9GR102 cm56x56x91h Fabric: cat. H art. Sahco Kent col. 3 Base: OPR15 moka matt stained oak. Detail of Carrara marble top



Clipper Low | Kyoto | Clip | Thor

**CLIPPER LOW sofa** 9CLL203 cm264x95x90h Fabric: cat. F art. Misia Aime col. M188-319 Terre di Sienne | Feet: OPM15 antique gold brushed metal **Cushions:** 2 x 9CU106 cm45x45 Fabric: cat. F art. Misia Aime col. M188-319 Terre di Sienne **THOR side table** 7TH104 cm50x50x50h OPP16 Sahara noir marble **KYOTO coffee table** 7KY107 øcm80x38h Base: OPM16 shiny brass chrome metal | Top: OPP16 Sahara Noir marble **CLIP side table** 7CL118 øcm40x50h OPM16 shiny brass chrome metal







**CLIP** coffee table 7CL118 øcm40x50h OPM16 shiny brass chrome metal **KYOTO** coffee table 7KY109 øcm100x38h Base: OPM16 shiny brass chrome metal Top: OPP2 Marquinia black marble < **CLIPPER** sofa in fabric cat. F art. Misia Aime col. M188-319 Terre di Sienna with **THOR** side table in Sahara noir marble





Clipper Chair | Twig Dining Table

**TWIG dining table** 7TG136 cm300x120x74h Base: OPM15 antique gold brushed metal | Top: OPP7 Calacatta gold marble **CLIPPER chair** and **small armchair**  
 9CLX302 cm53x62x84h, 9CLX304 cm62x64x86h Fabric: cat. H art. Sahco Avalon 2 col. 021 | Base: OPM15 antique gold brushed metal

**marelli**



**TWIG dining table** 7TG136 cm300x120x74h Base: OPM15 antique gold brushed metal | Top: OPP7 Calacatta gold marble **CLIPPER chair** and **small armchair** 9CLX302 cm53x62x84h, 9CLX304 cm62x64x86h Fabric: cat. H art. Sahco Avalon 2 col. 021 | Base: OPM15 antique gold brushed metal





**CLIPPER chair** 9CLX304 cm62x64x86h Fabric: cat. H art. Sahco Avalon 2 col. 021 | Base: OPM15 antique gold brushed metal



CLIPPER small armchair 9CLX304 cm62x64x86h Fabric: cat. H art. Casamance Mollino 47180365 Tourterelle | Base: OPM15 antique gold brushed metal



**TWIG dining table** 7TG136 cm300x120x74h Base: OPM15 antique gold brushed metal | Top: OPP7 Calacatta gold marble **CLIPPER small armchairs** 9CLX304 cm62x64x86h Fabric: cat. H art. Casamance Mollino 47180365 Tourterelle | Base: OPM15 antique gold brushed metal



Matheus | Tab | Thor | Mini

**MATHEUS composition** cm320x300 Fabric: cat. H art. Sahco Zero col. 12 | Base: OPM18 anodyc bronze painted metal **Extra cushions:** 1 x 9CU106 cm45x45 Fabric: cat. H art. Rubelli Spritz col. 16 moro | 2 x 9CU103 cm40x40 Fabric: cat. H art. Misia M260 7 01 col. 01 Sépia **TAB coffee table** 7TAB114 øcm125x36h Base: OPM18 anodyc bronze painted metal | Upper top: OPP3 Emperador brown marble | Lower top: OPV9 chrome back-painted bronze metal **THOR side table** 7TH204 cm50x50x50h OPM15 antique gold brushed metal

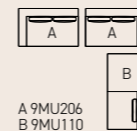

marelli



**MINI side table** 7TX160 cm25x40x50h OPM15 antique gold brushed meta **MATHEUS composition** cm320x300 Fabric: cat. H art. Sahco Zero col. 12



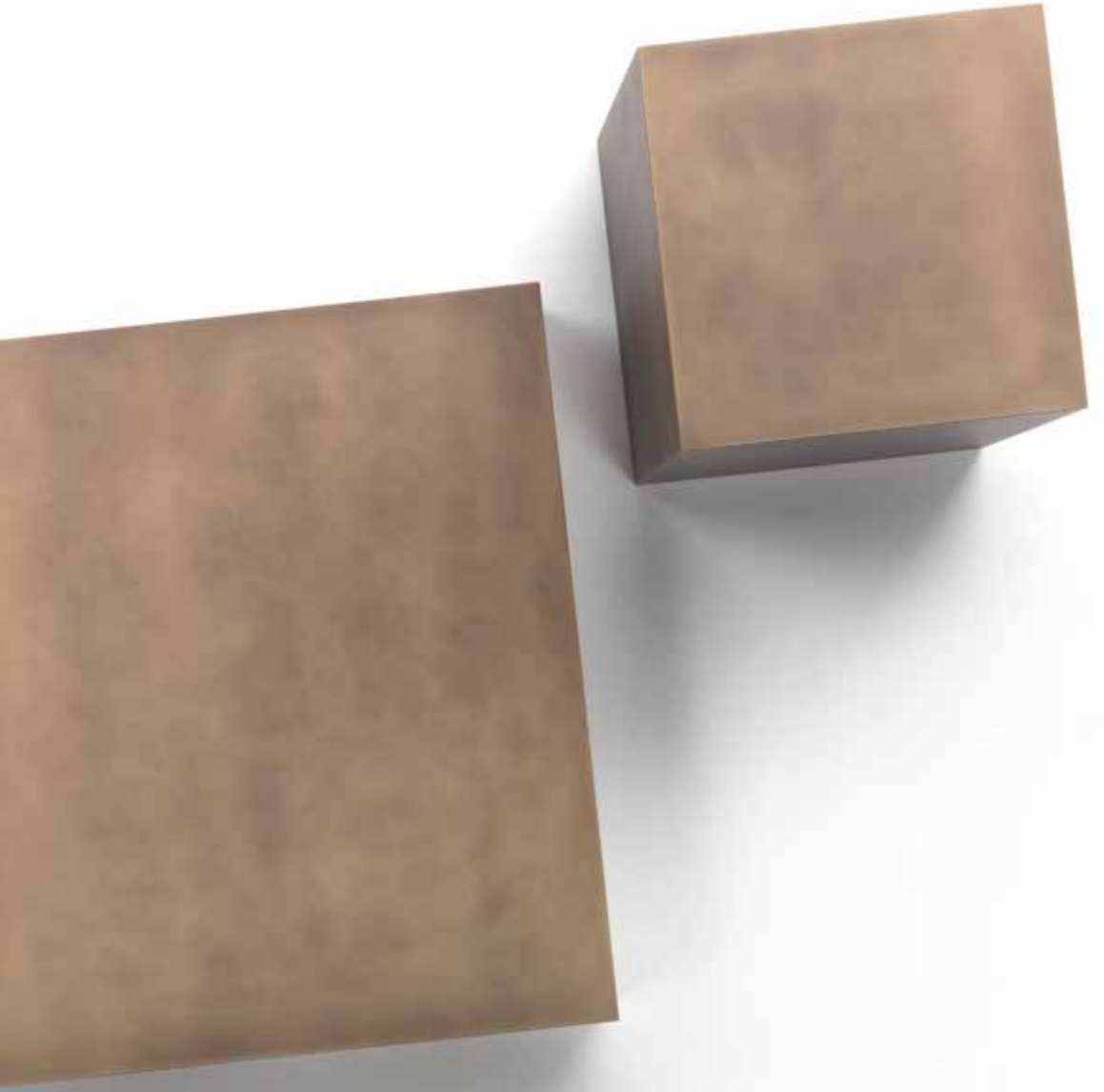

THOR side tables 7TH204 cm50x50x50h, 7TH202 cm100x100x19h OPM15 antique gold brushed metal





Matheus | Kyoto | Thor | Atene

**MATHEUS composition** cm320x225 Fabric: cat. H art. Designers Guild Glenville F1872/06 nutmeg | Base: OPM18 anodyc bronze painted metal **Decorative cushions:**  
 3 x 9MU101 cm50x50 with band Fabric: cat. H art. Designers Guild Glenville F1872/06 nutmeg | 1 x 9CU105 cm50x50, 1 x 9CU103 cm40x40 Fabric: cat. H art.  
 Casamance Mollino 47180365 Tourterelle **KYOTO coffee tables** 7KY101 øcm40x48h, 7KY109 øcm100x38h Base: OPM16 shiny brass chrome metal | Top: OPP2  
 Marquinia black marble **THOR side table** 7TH102 cm100x100x19h OPP2 Marquinia black marble

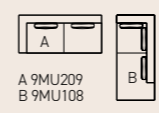

**marelli**





A 9MU206

**MATHEUS composition** cm320x100x88h Fabric: cat. H art. Sahco Avalon col. 021 | Base: OPM15 antique gold brushed metal **Extra cushions:** 2 x 9MU102 cm60x60 with band | 1 x 9CU106 cm45x45 Fabric: cat. H art. Sahco Avalon col. 021 | 1 x 9CU106 cm45x45 Fabric: cat. H art. Rubelli Vello d'Oro 30085-015 pavone **ATENE coffee tables** 7AT105 øcm120x30h, 7AT101 øcm50x40h Base: OPM17 bronze metal | Top: OPP3 Emperador brown marble



ATENE coffee tables 7AT105 øcm120x30h, 7AT101 øcm50x40h Base: OPM17 bronze metal | Top: OPP3 Emperador brown marble





Tatlin Dining Table | Paris | Chia

**TATLIN dining table** 7TAT128 øcm150x74h Base: OPM11 gold pearl painted metal | Top: OPG3 Statuario Select Porcelain Stoneware **CHIA chairs** 9CHI104 cm58x53x77h Outside: Leather cat. Lusso art. Nabuk col. C/3436 bluette | Inside: Fabric cat. H art. Sahco Avalon col. 2194-001 blue

**marelli**

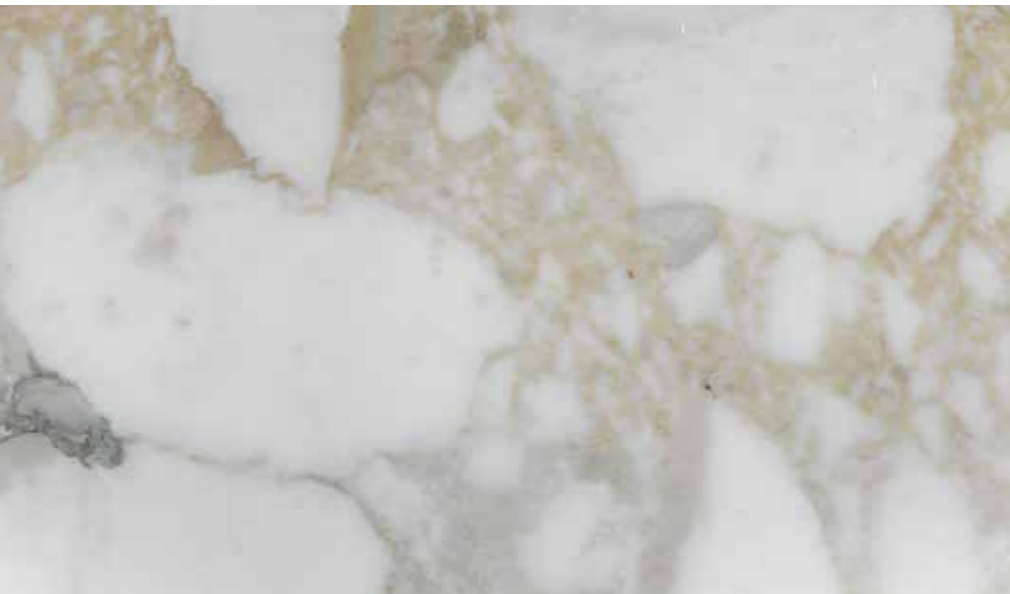

**TATLIN dining table** 7TAT128 øcm150x74h Base: OPM11 gold pearl painted metal | Top: OPG3 Statuario Select Porcelain Stoneware **PARIS chairs** 9PAR101X cm53x61x90h Leather: cat. Lusso art. Nabuk col. C/3436 Bluette Wooden base covered in the same leather



**TATLIN dining table** 7TAT128 øcm150x74h Base: OPM11 gold pearl painted metal | Top: OPG3 Statuario Select Porcelain Stoneware **CHIA chairs** 9CHI104 cm58x53x77h Outside: Leather cat. Lusso art. Nabuk col. C/3436 bluette | Inside: Fabric cat. H art. Sahco Avalon col. 2194-001 blue





**TATLIN dining table** 7TAT128 øcm150x74h Base: OPM11 gold pearl painted metal | Top: OPG3 Statuario Select Porcelain Stoneware **CHIA chairs** 9CHI104 cm58x53x77h Outside: Leather cat. Lusso art. Nabuk col. C/3436 bluette | Inside: Fabric cat. H art. Sahco Avalon col. 2194-001 blue



Tatlin Dining Table | Kyoto Sideboard | Megan

**KYOTO sideboard** 7KY207 cm220x50x71h Top: OPP13 Velvet brown marble | Base: OPM15 antique gold brushed metal | Structure: OPR3 Walnut stained oak **TATLIN dining table** 7TAT130 cm180x180x74h Base: OPM15 antique gold brushed metal | Top: OPR3 Walnut stained oak **MEGAN chairs** 9ME101 cm53x57x89h Fabric: cat. H art. Rubelli Spritz col. 18 bronzo | Base: OPR15 moka matt stained oak



**TATLIN dining table** 7TAT130 cm180x180x74h Base: OPM15 antique gold brushed metal | Top: OPR3 Walnut stained oak **MEGAN chairs** 9ME101 cm53x57x89h  
Fabric: cat. H art. Rubelli Spritz col. 18 bronzo | Base: OPR15 moka matt stained oak



**TATLIN dining table** 7TAT130 cm180x180x74h Base: OPM15 antique gold brushed metal | Top: OPR3 Walnut stained oak **MEGAN chairs** 9ME101 cm53x57x89h Fabric: cat. H art. Rubelli Spritz col. 18 bronzo | Base: OPR15 moka matt stained oak





KYOTO sideboard 7KY207 cm220x50x71h Top: OPP13 Velvet brown marble | Base: OPM15 antique gold brushed metal | Structure: OPR3 Walnut stained oak



**SLIDE composition** cm305x180 Fabric: cat. H art. Rubelli Spritz col. 25 lichene | Base D: OPM15 antique gold brushed metal **Cushions:** 2 x 9VR102 cm45x45 with band Fabric: cat. H art. Rubelli Spritz col. 25 lichene | 1 x 9CU103 cm40x40 Fabric: cat. H art. Casamance Vetiver 440 80 252 **THOR table** 7TH202 cm100x100x19h OPM15 antique gold brushed metal **TWIG coffee tables** 7TG103 øcm100x35h, 7TG102 øcm60x40h Base: OPM16 shiny brass chrome metal | Top: OPP7 Calacatta gold marble **CLIP side table** 7CL116 øcm40x50h OPM16 shiny brass chrome metal

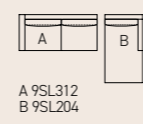

Slide | Clipper | Twig | Thor | Clip

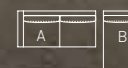

A 9SL312  
B 9SL204

**SLIDE composition** cm305x180 Fabric: cat. H art. Rubelli Spritz col. 25 lichene | Base D: OPM15 antique gold brushed metal **Cushions:** 2 x 9VR102 cm45x45 with band Fabric: cat. H art. Rubelli Spritz col. 25 lichene | 1 x 9CU103 cm40x40 Fabric: cat. H art. Casamance Vetiver 440 80 252 **CLIPPER armchairs** 9CLX107 cm70x76x75h Fabric: cat. I art. Casamance Vetiver 440 80 252 | Base: OPM15 antique gold brushed metal **THOR table** 7TH202 cm100x100x19h OPM15 antique gold brushed metal **TWIG coffee tables** 7TG103 øcm100x35h, 7TG102 øcm60x40h Base: OPM16 shiny brass chrome metal | Top: OPP7 Calacatta gold marble **CLIP side table** 7CL116 øcm40x50h OPM16 shiny brass chrome metal



Table tops in OPP2 Calacatta gold marble and OPP9 Black and gold marble  
< **THOR table** 7TH202 cm100x100x19h OPM15 antique gold brushed metal







**CLIPPER armchairs** 9CLX107 cm70x76x75h Fabric: cat. H art. Casamance Vetiver 440 80 252 | Base: OPM15 antique gold brushed metal



Gordon Round | Nest | Atene

**GORDON ROUND QUILTED composition** cm400x350 **Cushions:** 2 x with band 9G0107 cm45x45 Fabric: cat. H art. Rubelli Spritz col. 18 bronzo **Extra cushions:** 1 x 9CU105 cm50x50, 1 x 9CU103 cm40x40 Fabric: cat. H art. Rubelli Spritz col. 15 ambra | 1 x 9CU105 cm50x50, 1 x 9CU103 cm40x40 Fabric: cat. H art. Casamance Mollino 47180365 Tourterelle **NEST armchairs** 9NE101 cm73x80x90h Fabric: cat. F art. Rubelli Spritz col. 11 Ambra | Base: OPM15 antique gold brushed metal **ATENE coffee tables** 7AT105 øcm120x30h, 7AT102 øcm50x50h Base: OPM16 shiny brass chrome marble | Top: OPP21 Calacatta violet marble

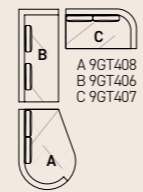





ATENE coffee tables 7AT105 øcm120x30h, 7AT102 øcm50x50h Base: OPM16 shiny brass chrome marble | Top: OPP21 Calacatta violet marble



**NEST armchairs** 9NE101 cm73x80x90h Fabric: cat. F art. Rubelli Spritz col. 11 Ambra | Base: OPM15 antique gold brushed metal



Details of **ATENA** coffee table with OPP21 Calacatta violet marble top and **NEST** armchairs







Gordon | Clipper | Twig | Clip

**GORDON composition** cm340x325 Leather: cat. Lusso art. Nabuk col. C/3436 Bluette Meta | Feet: OPM15 antique gold brushed metal **Cushions:** 4 x 9G0107 cm45x45 with band | Leather: cat. Lusso art. Nabuk col. C/3436 Bluette | 1 x 9CU106 cm45x45, 1 x 9CU105 cm50x50 Fabric: cat. H art. Rubelli Spritz col. 24 Reseda  
**CLIPPER armchairs** 9CLX107 cm70x76x75h Fabric: cat. H art. Rubelli Spritz col. 24 Reseda | Base: OPM13 antique brass brushed metal **TWIG coffee tables** 7TG103 øcm100x35h, 7TG102 øcm60x40h Base: OPM15 antique gold brushed metal | Top: Onyx

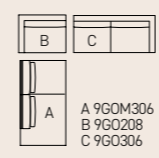

marelli



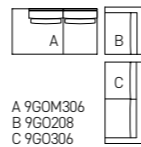

A 9GOM306  
B 9GO208  
C 9GO306

**CLIP side tables** 7CL118  $\varnothing$ cm40x50h, 7CL116  $\varnothing$ cm60x27h OPM15 antique gold brushed metal **GORDON composition** cm340x325 Leather: cat. Lusso art. Nabuk col. C/3436 Bluette Meta | Feet: OPM15 antique gold brushed metal **TWIG coffee tables** 7TG103  $\varnothing$ cm100x35h 7TG102  $\varnothing$ cm60x40h Base: OPM15 antique gold brushed metal | Top: Onyx



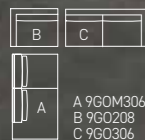

A 9GOM306  
B 9GO208  
C 9GO306

**GORDON composition** cm340x325 Leather: cat. Lusso art. Nabuk col. C/3436 Bluette Meta | Feet: OPM15 antique gold brushed metal **Cushions:** 4 x 9G0107 cm45x45 with band Leather: cat. Lusso art. Nabuk col. C/3436 Bluette | 1 x 9CU106 cm45x45, 1 x 9CU105 cm50x50 Fabric: cat. H art. Rubelli Spritz col. 24 Reseda  
**CLIPPER armchairs** 9CLX107 cm70x76x75h Fabric: cat. H art. Rubelli Spritz col. 24 Reseda | Base: OPM13 antique brass brushed metal **TWIG coffee tables** 7TG103 øcm100x35h, 7TG102 øcm60x40h Base: OPM15 antique gold brushed metal | Top: Onyx



**CLIPPER armchairs** 9CLX107 cm70x76x75h Fabric: cat. H art. Rubelli Spritz col. 24 Reseda | Base: OPM13 antique brass brushed metal



Self Bespoke Table | Chia

**SELF bespoke table** cm450x110x74h Base: OPM18 anodyc bronze painted metal | Top: OPP17 Port Laurent marble **CHIA chairs** 9CHI104 cm58x53x77h Inside: Fabric cat. H art. Dedar Splendido col. Sand 15016-018 | Outside: Fabric cat. H art. Dedar Splendido col. Black 15016-005 | Base: OPM10 Golden beach painted metal





**SELF bespoke table** cm450x110x74h Base: OPM18 anodyc bronze painted metal | Top: OPP17 Port Laurent marble **CHIA chairs** 9CHI104 cm58x53x77h Inside: Fabric cat. H art. Dedar Splendido col. Sand 15016-018 | Outside: Fabric cat. H art. Dedar Splendido col. Black 15016-005 | Base: OPM10 Golden beach painted metal



Self Dining Table | Chia | Frame

**SELF dining table** 7SEL104 cm240x110x74h Base: OPM15 antique gold brushed metal | Top: OPP16 Sahara Noir marble **CHIA chairs** 9CHI104 cmcm58x53x77h  
Fabric: cat. H art. Sahco Zero col. 001 | Base: OPM13 antique brass brushed metal

**marelli**



**SELF dining table** 7SEL104 cm240x110x74h Base: OPM15 antique gold brushed metal | Top: OPP16 Sahara Noir marble **CHIA chairs** 9CHI104 cmcm58x53x77h  
Fabric: cat. H art. Sahco Zero col. 001 | Base: OPM13 antique brass brushed metal





**FRAME console** 7FR130 cm200x40x70h Base: OPM15 antique gold brushed metal Tops: OPP17 Port Laurent marble



Nest | Cassiopea | Twig

**NEST armchairs** 9NE101 cm73x80x90h Fabric: cat. H art. Casamance Mollino 47180365 Tourterelle | Base: OPM15 antique gold brushed metal **NEST sofa** 9NE201 cm150x80x90h Fabric: cat. H art. Rubelli Spritz col. 16 moro | Base: OPM15 antique gold brushed metal **TWIG coffee table** 7TG103 øcm100x35h Base: OPM18 anodyc bronze painted metal | Top: OPP3 Emperador brown marble **CASSIOPEA side tables** 7CP101 øcm42x40h, 7CP102 øcm52x50h Base: OPM15 antique gold brushed metal | Top: OPP3 Emperador brown marble



**NEST armchairs** 9NE101 cm73x80x90h Fabric: cat. H art. Casamance Mollino 47180365 Tourterelle | Base: OPM15 antique gold brushed metal **NEST sofa** 9NE201 cm150x80x90h Fabric: cat. H art. Rubelli Spritz col. 16 moro | Base: OPM15 antique gold brushed metal **TWIG coffee table** 7TG103 øcm100x35h Base: OPM18 anodized bronze painted metal | Top: OPP3 Emperador brown marble **CASSIOPEA side tables** 7CP101 øcm42x40h, 7CP102 øcm52x50h Base: OPM15 antique gold brushed metal | Top: OPP3 Emperador brown marble



**NEST armchairs** 9NE101 cm73x80x90h Fabric: cat. H art. Casamance Mollino 47180365 Tourterelle | Base: OPM15 antique gold brushed metal



NEST sofa 9NE201 cm150x80x90h Fabric: cat. H art. Rubelli Spritz col. 16 moro | Base: OPM15 antique gold brushed metal



**CASSIOPEA side tables** 7CP101  $\varnothing$ cm42x40h, 7CP102  $\varnothing$ cm52x50h Base: OPM15 antique gold brushed metal | Top: OPP3 Emperador brown marble



Anderson Dining Table | Clipper Chair

**ANDERSON dining table** 7AND101 cm255x110x71,5h Base: OPR15 moka matt stained oak | Top: OPG4 Calacatta Royal porcelain stoneware **CLIPPER chairs** and **small armchairs** 9CLX301 cm53x62x84h, 9CLX303 cm62x64x86h Fabric: cat. H art. Casamance Interview 3691/0541 | Base: OPR15 moka matt stained oak

**marelli**



**ANDERSON** dining table 7AND101 cm255x110x71,5h Base: OPR15 moka matt stained oak | Top: OPG4 Calacatta Royal porcelain stoneware **CLIPPER** chairs and small armchairs 9CLX301 cm53x62x84h, 9CLX303 cm62x64x86h Fabric: cat. H art. Casamance Interview 3691/0541 | Base: OPR15 moka matt stained oak





Detail of **ANDERSON dining table** 7AND101 cm255x110x71,5h Base: OPR15 moka matt stained oak | Top: OPG4 Calacatta Royal porcelain stoneware



**ANDERSON dining table** 7AND101 cm255x110x71,5h Base: OPR15 moka matt stained oak | Top: OPG4 Calacatta Royal porcelain stoneware **CLIPPER chairs** and **small armchairs** 9CLX301 cm53x62x84h, 9CLX303 cm62x64x86h Fabric: cat. H art. Casamance Interview 3691/0541 | Base: OPR15 moka matt stained oak



**ANDERSON dining table** 7AND101 cm255x110x71,5h Base: OPR15 moka matt stained oak | Top: OPG4 Calacatta Royal porcelain stoneware **CLIPPER chairs** and **small armchairs** 9CLX301 cm53x62x84h, 9CLX303 cm62x64x86h Fabric: cat. H art. Casamance Interview 3691/0541 | Base: OPR15 moka matt stained oak



**MOON sofa** 9MN203 cm245x120x76h Fabric: cat. H art. Rubelli Spritz col. 18 bronzo | Base: OPM15 antique gold brushed metal **Cushions:** 1 x 9CU106 cm45x45 | Fabric: cat. H art. Sahco Zero col. 012 | 1 x 9CU106 cm45x45 Fabric: cat. H art. Misia art. M260 7 01 col. 01 Sépia **SIGN armchairs** 9SI102 cm83x75x75h Fabric: cat. G art. Orsetto col. 01/1 | Base: OPR15 moka matt stained oak **ATENE coffee tables** 7AT111 øcm50x40h, 7AT113 øcm80x30h Base: OPM15 antique gold brushed metal | Top: OPV9 chrome back-painted bronze glass



**MOON sofa** 9MN203 cm245x120x76h Fabric: cat. H art. Rubelli Spritz col. 18 bronzo | Base: OPM15 antique gold brushed metal **Cushions:** 1 x 9CU106 cm45x45 Fabric: cat. H art. Sahco Zero col. 012 | 1 x 9CU106 cm45x45 Fabric: cat. H art. Mísia art. M260 7 01 col. 01 Sépia **ATENE coffee tables** 7AT111 øcm50x40h, 7AT113 øcm80x30h Base: OPM15 antique gold brushed metal | Top: OPV9 chrome back-painted bronze glass



**MOON sofa** 9MN203 cm245x120x76h Fabric: cat. H art. Rubelli Spritz col. 18 bronzo | Base: OPM15 antique gold brushed metal **Cushions:** 1 x 9CU106 cm45x45 Fabric: cat. H art. Sahco Zero col. 012 | 1 x 9CU106 cm45x45 Fabric: cat. H art. Misia art. M260 7 01 col. 01 Sépia **SIGN armchair** 9SI102 cm83x75x75h Fabric: cat. G art. Orsetto col. 01/1 | Base: OPR15 moka matt stained oak **ATENE coffee tables** 7AT111 øcm50x40h, 7AT113 øcm80x30h Base: OPM15 antique gold brushed metal | Top: OPV9 chrome back-painted bronze glass





Alexander | Nest | Atene

**ALEXANDER composition** cm390 Fabric: cat. H art. Rubelli Vello d'Oro col. 30085-002 sabbia **Cushions:** 1 x 9CU104 cm60x60 Fabric: cat. H art. Rubelli Spritz Ambra | 2 x 9CU106 cm45x45 Fabric: cat. H art. Sahco Avalon 2 col. 004 | 2 x 9CU106 cm45x45 Fabric: cat. H art. Misia M2618 01 2 Ivoire | 2 x 9CU105 cm50x50 Fabric: cat. H art. Designers Guild Glenville F1872-06 Nutmeg | 1 x 9CU105 cm50x50 | Fabric: cat. H art. Rubelli Vello d'oro col. 02 sabbia **NEST armchairs** 9NE101 cm73x80x90h Fabric: cat. H art. Rubelli Spritz 11 Ambra | Base: OPM15 antique gold brushed metal **ATENE coffee tables** 9AT105 øcm120x30h, 9AT102 øcm50x50h Base: OPM15 antique gold brushed metal | Top: OPP7 Calacatta gold marble

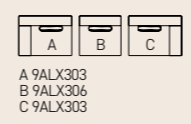

marelli



**ATENE coffee tables** 9AT105 øcm120x30h, 9AT102 øcm50x50h Base: OPM15 antique gold brushed metal | Top: OPP7 Calacatta gold marble



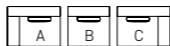

A 9ALX303  
 B 9ALX306  
 C 9ALX308

**ALEXANDER composition** cm390 Fabric: cat. H art. Rubelli Vello d'Oro col. 30085-002 sabbia **Cushions:** 1 x 9CU104 cm60x60 Fabric: cat. H art. Rubelli Spritz Ambra | 2 x 9CU106 cm45x45 Fabric: cat. H art. Sahco Avalon 2 col. 004 | 2 x 9CU106 cm45x45 Fabric: cat. H art. Misia M2618 01 2 Ivoire | 2 x 9CU105 cm50x50 Fabric: cat. H art. Designers Guild Glenville F1872-06 Nutmeg | 1 x 9CU105 cm50x50 Fabric: cat. H art. Rubelli Vello d'oro col. 02 sabbia **NEST armchairs** 9NE101 cm73x80x90h Fabric: cat. H art. Rubelli Spritz 11 Ambra | Base: OPM15 antique gold brushed metal





**ALEXANDER composition** cm355x355 Fabric: cat. H art. Rubelli Vello d'Oro col. 30085-002 sabbia **Cushions:** 1 x 9CU106 cm45x45 Fabric: cat. H art. Rubelli Spritz Ambra | 2 x 9CU106 cm45x45 Fabric: cat. H art. Sahco Avalon 2 col. 004 | 2 x 9CU106 cm45x45 Fabric: cat. H art. Misia M2618 01 2 Ivoire | 3 x 9CU105 cm50x50 Fabric: cat. H art. Designers Guild Glenville F1872-06 Nutmeg | 1 x 9CU105 cm50x50 Fabric: cat. H art. Rubelli Vello d'oro col. 02 sabbia **CLIPPER armchairs** 9CLX105 cm70x76x75h Outside: Leather cat. Super art. Dollaro 7070 | Inside: Fabric cat. H art. Rubelli Vello d'oro 30085-001 sabbia **BREAK coffee table** 7BR103 øcm80x27h, 7BR101 øcm40x45h Base: OPM15 antique gold brushed metal | Top: OPP3 Emperador brown marble | 7BR118 øcm60x36h Base: OPM16 shiny brass chrome metal | Top: OPV12 transparent bronze glass **THOR table** 7TH202 cm100x100x19h OPM15 antique gold brushed metal

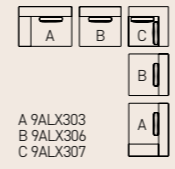

**marelli**

Alexander | Clipper | Break | Thor | Cassiopea



Detail of **ALEXANDER** sofa in fabric cat. H art. Rubelli Vello d'oro col. 002 sabbia and **BREAK** coffee tables with OPP3 Emperador brown marble and OPV12 transparent bronze glass top



**CASSIOPEA coffee table** 7CP101 øcm40x42h, 7CP102 øcm50x52h Base: OPM15 antique gold brushed metal | Top: OPP3 Emperador brown marble Details of **ALEXANDER composition** in fabric cat. H art. Rubelli Vello d'oro col. 002 sabbia





**CLIPPER armchairs** 9CLX105 cm70x76x75h Outside: Leather cat. Super art. Dollaro 7070 | Inside: Fabric cat. H art. Rubelli Vello d'oro 30085-001 sabbia  
**CASSIOPEA coffee table** 7CP102 øcm50x52h Base: OPM15 antique gold brushed metal | Top: OPP3 Emperador brown marble



**ALEXANDER composition** cm330x186 Fabric: cat. H art. Dedar Elektra T20027-16 bleu horizon **Extra cushions:** 2 x 9CU105 cm50x50 Fabric: cat. H art. Dedar Elektra T20027-16 bleu horizon | 1 x 9CU106 cm45x45 Fabric: cat. H art. Sahco Avalon col. 004 **ATENE coffee tables** 9AT105 øcm120x30h, 9AT101 øcm50x40h Base: OPM17 bronze metal | Top: OPP3 Emperador brown marble **WAVE coffee table** 7WA101 øcm50x47h Base: OPM19 Délabré pewter brushed metal | Top: OPP3 Emperador brown marble

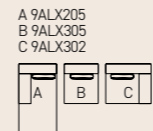

Alexander | Atene | Wave | Kyoto





**KYOTO sideboard** 7KY312 cm220x50x71h Structure: OPR15 moka matt stained oak | Base: OPM15 antique gold brushed metal | Top: OPV6 RAL 1019 back-painted glass





Details of **KYOTO sideboard** 7KY312 cm220x50x71h Structure: OPR15 moka matt stained oak | Base: OPM15 antique gold brushed metal | Top: OPV6 RAL 1019 back-painted glass



Hebo | Paris

**HEBO dining table** 7HEB103 cm260x120x72h OPP18 Arabescato Vagli marble **PARIS chairs** 9PAR101X cm53x61x90h, 9PAR103X cm59x61x83h Leather: cat. Lusso  
 art. Nabuk col. C/3436 Bluette Wooden base covered in the same leather

**marelli**



Details of **HEBO dining table** 7HEB103 cm260x120x72h OPP18 Arabescato Vagli marble





HEBO dining table 7HEB103 cm260x120x72h OPP18 Arabescato Vagli marble



Atacama | Wave

**ATACAMA sofa** 9ATC101 cm225x145x80h Fabric: cat. D/E art. Gabriel Crisp 04125 **ATACAMA sofa** 9ATC102 cm225x145x80h **ATACAMA ottomans** 9ATC106 cm85x75x44h Fabric: cat. D/E art. Gabriel Crisp 04731 **WAVE coffee tables** 7WA104 øcm120x27h Base: OPM20 Délabré brass brushed metal | Top: OPP7 Calacatta gold marble | 7WA112 øcm60x37h Base: OPM20 Délabré brass brushed metal | Top: OPV6 RAL 1019 back-painted glass



ATACAMA sofa 9ATC102 cm225x145x80h Fabric: cat. D/E art. Gabriel Crisp 04731 ATACAMA sofa 9ATC101 cm225x145x80h Fabric: cat. D/E art. Gabriel Crisp 04125









Atacama | Lobel Bookshelf | Clip

**ATACAMA sofa** 9ATC102 cm225x145x80h **LOBEL bookshelf** 7LOB104 cm180x45x185h Structure: OPM16 shiny brass chrome metal | Tops: OPV12 transparent glass  
**CLIP coffee table** 7CL118 øcm40x50h OPM16 shiny brass chrome metal

**marelli**

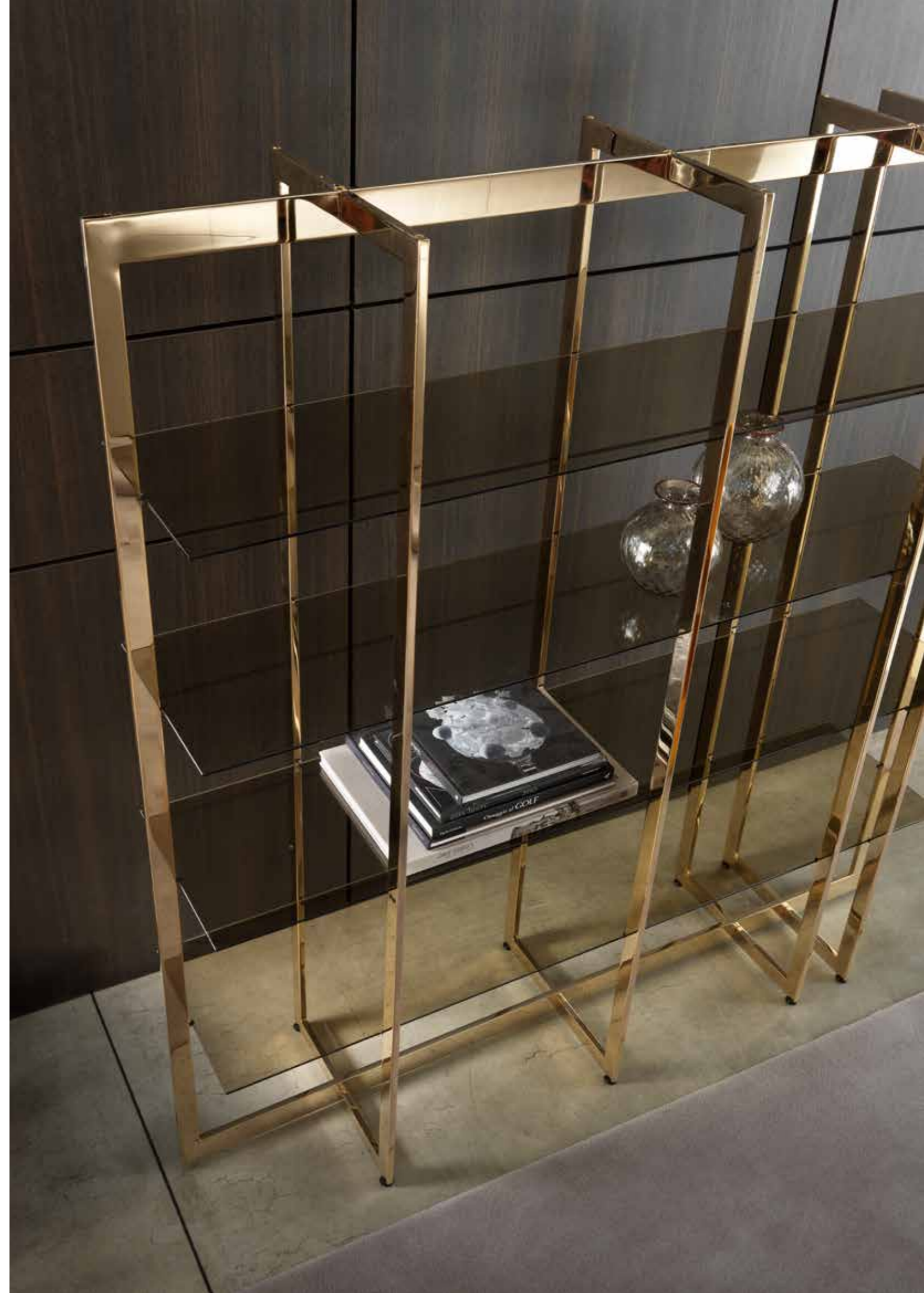

**ATACAMA sofa** 9ATC102 cm225x145x80h **LOBEL bookshelf** 7LOB104 cm180x45x185h Structure: OPM16 shiny brass chrome metal | Tops: OPV12 transparent glass  
**CLIP coffee table** 7CL118 øcm40x50h OPM16 shiny brass chrome metal



Xela | Paris | Joy | Clip | Break

**XELA dining table** 7XL101 cm240x120x74h Base: OPM15 antique gold brushed metal | Top: OPP13 Velvet brown marble **PARIS chairs** 9PAR101 cm53x61x90h, 9PAR103 cm59x61x83h Fabric: cat. H art. Rubelli Spritz col. 24 Reseda | Base: OPR15 moka matt stained oak

**marelli**



PARIS chairs 9PAR101 cm53x61x90h, 9PAR103 cm59x61x83h Fabric: cat. H art. Rubelli Spritz col. 24 Reseda | Base: OPR15 moka matt stained oak

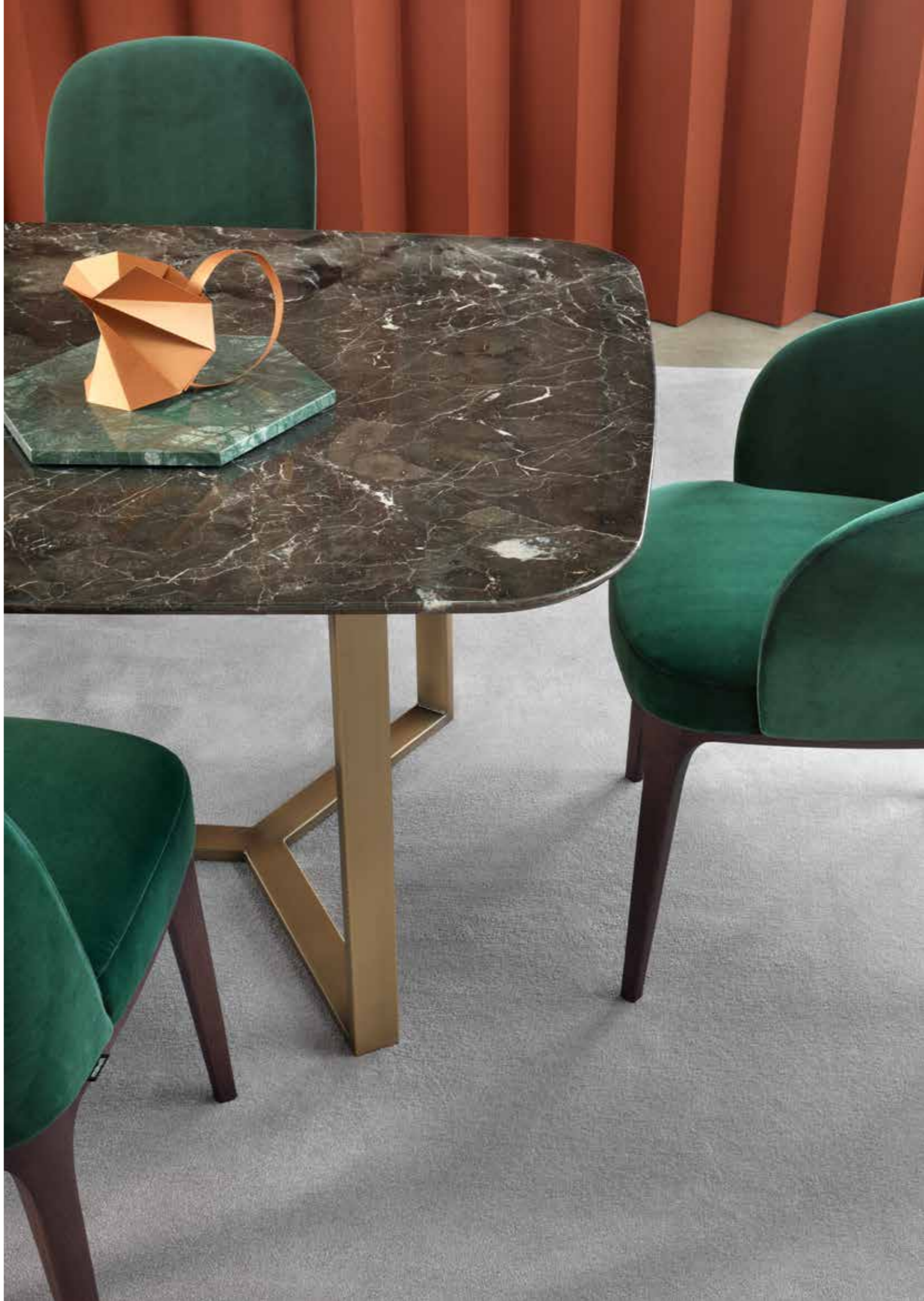



**JOY armchairs** 9JY9102 cm75x82x79h Fabric: cat. H art. Rubelli Spritz col. 24 Reseda | Base A OPM12 antique brass brushed metal **CLIP coffee table** 7CL117  
øcm40x40h OPM17 bronze metal **BREAK coffee table** 7BR119 øcm80x27h Base: OPM12 antique brass brushed metal | Top: OPV1 Transparent glass

# Colori e finiture







COLOURS AND FINISHES

# Finiture metallo

METAL FINISHES

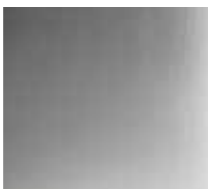
330

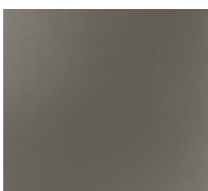
LIFESTYLE COLLECTION 2021 \_ MARELLI

<b>OPM1</b> Metallo cromo lucido <i>Shiny chrome metal</i> Metall glänzend verchromt Métal chromé brillant		<b>OPM7</b> Metallo verniciato RAL 9016 bianco <i>RAL 9016 white painted metal</i> Metall RAL 9016 weiss lackiert Métal laqué blanc RAL 9016	
<b>OPM2</b> Metallo spazzolato cromo satinato <i>Brushed matt chrome metal</i> Metall matt verchromt (gebürstet) Métal chromé mat (brossé)		<b>OPM9</b> Metallo verniciato classic bronze <i>Classic bronze painted metal</i> Metall classic bronze lackiert Métal laqué classic bronze	
<b>OPM3</b> Metallo spazzolato canna di fucile <i>Brushed matt dark grey metal</i> Metall dunkelgrau gebürstet Métal brossé canon de fusil		<b>OPM10</b> Metallo verniciato golden beach <i>Golden beach painted metal</i> Metall golden beach lackiert Métal laqué golden beach	
<b>OPM6</b> Metallo verniciato RAL 9017 nero <i>RAL 9017 black painted metal</i> Metall RAL 9017 schwarz lackiert Métal laqué noir RAL 9017			

# Finiture metallo

METAL FINISHES

331

LIFESTYLE COLLECTION 2021 \_ MARELLI

<b>OPM11</b> Metallo verniciato gold pearl <i>Gold pearl painted metal</i> Metall gold pearl lackiert Métal laqué gold pearl		<b>OPM16</b> Metallo cromo ottone lucido <i>Shiny brass chrome metal</i> Metall Messing glänzend verchromt Métal chromé laiton brillant	
<b>OPM12</b> Metallo spazzolato rame <i>Brushed copper metal</i> Metall Kupfer gebürstet Métal brossé cuivre		<b>OPM17</b> Metallo bronzo <i>Bronze metal</i> Metallica Bronze Métal bronze	
<b>OPM13</b> Metallo spazzolato ottone antico <i>Brushed antique brass metal</i> Metall Antik Messing gebürstet Métal brossé laiton antique		<b>OPM18</b> Metallo verniciato anodyc bronze <i>Anodyc bronze painted metal</i> Métal laqué anodyc bronze Metall Anodyc Bronze lackiert	
<b>OPM14</b> Metallo cromo nero lucido <i>Shiny black chrome metal</i> Metall schwarz glänzend verchromt Métal chromé noir brillant		<b>OPM19</b> Metallo spazzolato peltro Délabré <i>Délabré pewter brushed metal</i> Metall Zinn délabré gebürstet Métal brossé étain délabré	
<b>OPM15</b> Metallo spazzolato oro antico <i>Brushed antique gold metal</i> Metall Antik gold gebürstet Métal brossé or antique		<b>OPM20</b> Metallo spazzolato ottone Délabré <i>Délabré brass brushed metal</i> Metall Messing délabré gebürstet Métal brossé laiton délabré	

# Finiture rovere









OAK FINISHES

# Finiture vetro

GLASS FINISHES



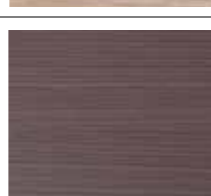
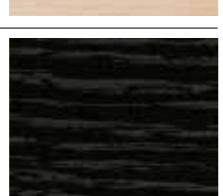

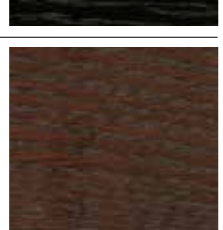
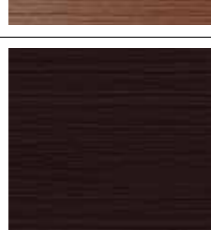

332

LIFESTYLE COLLECTION 2021 \_ MARELLI

<p><b>OPR1</b> Rovere tinto ciliegio <i>Cherry stained oak</i> <i>Eiche Kirschbaum gebeizt</i> <i>Chêne teinté merisier</i></p>		<p><b>OPR8</b> Rovere tinto tabacco <i>Tobacco stained oak</i> <i>Eiche tabak gebeizt</i> <i>Chêne teinté tabac</i></p>	
<p><b>OPR2</b> Rovere tinto wengé <i>Wengé stained oak</i> <i>Eiche Wenge gebeizt</i> <i>Chêne teinté wengé</i></p>		<p><b>OPR9</b> Rovere tinto grigio tortora <i>Grey taupe stained oak</i> <i>Eiche beige-grau gebeizt</i> <i>Chêne teinté taupe</i></p>	
<p><b>OPR3</b> Rovere tinto noce <i>Walnut stained oak</i> <i>Eiche Nussbaum gebeizt</i> <i>Chêne teinté noyer</i></p>		<p><b>OPR10</b> Rovere sbiancato <i>Whitened oak</i> <i>Eiche gebleicht</i> <i>Chêne blanchi</i></p>	
<p><b>OPR4</b> Rovere tinto naturale <i>Natural oak</i> <i>Eiche natur farblos lackiert</i> <i>Chêne naturel</i></p>		<p><b>OPR11</b> Rovere tinto antracite <i>Charcoal stained oak</i> <i>Eiche Anthrazit gebeizt</i> <i>Chêne teinté anthracite</i></p>	
<p><b>OPR5</b> Rovere tinto nero <i>Black stained oak</i> <i>Eiche schwarz gebeizt</i> <i>Chêne teinté noir</i></p>		<p><b>OPR12</b> Rovere tinto mogano <i>Mahogany stained oak</i> <i>Eiche mahagonifarbig gebeizt</i> <i>Chêne teinté acajou</i></p>	
<p><b>OPR6</b> Rovere tinto ciliegio Milano <i>Cherry Milano stained oak</i> <i>Eiche Kirschbaum Milano gebeizt</i> <i>Chêne teinté merisier Milano</i></p>		<p><b>OPR15</b> Rovere tinto moka opaco <i>Moka matt stained oak</i> <i>Eiche moka matt gebeizt</i> <i>Chêne teinté moka mat</i></p>	

333

LIFESTYLE COLLECTION 2021 \_ MARELLI

<p><b>OPV1</b> Vetro trasparente <i>Transparent glass</i> <i>Klarglas</i> <i>Verre transparent</i></p>		<p><b>OPV7</b> Vetro retroverniciato nei colori RAL Classic <i>Glass back-painted in the RAL Classic colours</i> <i>Von hinten lackiertes Glas in den RAL Classic Farben</i> <i>Verre laqué de dessous dans les couleurs RAL Classic</i></p>	<p>Colori RAL standard RAL standard colours</p>
<p><b>OPV2</b> Vetro satinato <i>Frosted glass</i> <i>Mattglas</i> <i>Verre dépoli</i></p>		<p><b>OPV9</b> Vetro bronzato retroverniciato cromo <i>Chrome back-painted bronze glass</i> <i>Von hinten chromlackiertes Bronzenglas</i> <i>Verre bronzé laqué de dessous chrome</i></p>	
<p><b>OPV3</b> Vetro retroverniciato RAL 9016 bianco traffico <i>RAL 9016 traffic white back-painted glass</i> <i>RAL 9016 verkehrsweiß von hinten lackiertes Glas</i> <i>Verre laqué de dessous RAL 9016 blanc signalisation</i></p>		<p><b>OPV10</b> Vetro grigio retroverniciato cromo <i>Chrome back-painted grey glass</i> <i>Von hinten chromlackiertes Grauglas</i> <i>Verre gris laqué de dessous chrome</i></p>	
<p><b>OPV4</b> Vetro retroverniciato RAL 9017 nero traffico <i>RAL 9017 traffic black back-painted glass</i> <i>RAL 9017 verkehrsschwarz von hinten lackiertes Glas</i> <i>Verre laqué de dessous RAL 9017 noir signalisation</i></p>		<p><b>OPV12</b> Vetro bronzato trasparente <i>Transparent bronze glass</i> <i>Klarglas bronze</i> <i>Verre transparent bronzé</i></p>	
<p><b>OPV5</b> Vetro retroverniciato RAL 7044 grigio seta <i>RAL 7044 silk grey back-painted glass</i> <i>RAL 7044 seidengrau von hinten lackiertes Glas</i> <i>Verre laqué de dessous RAL 7044 gris soie</i></p>		<p><b>OPV13</b> Vetro grigio trasparente <i>Transparent grey glass</i> <i>Klarglas grau</i> <i>Verre transparent gris</i></p>	
<p><b>OPV6</b> Vetro retroverniciato RAL 1019 beige grigiastro <i>RAL 1019 grey beige back-painted glass</i> <i>RAL 1019 graubeige von hinten lackiertes Glas</i> <i>Verre laqué de dessous RAL 1019 beige gris</i></p>			



# Finiture marmi

MARBLES FINISHES

334

LIFESTYLE COLLECTION 2021 \_ MARELLI

## OPP1

Marmo Carrara bianco  
Carrara white marble  
Marmor Carrara weiss  
Marbre blanc Carrara



## OPP13

Marmo Velvet brown  
Velvet brown marble  
Marmor Velvet brown  
Marbre Velvet brown



## OPP14

Marmo Amani Bronze  
Amani Bronze marble  
Marmor Amani Bronze  
Marbre Amani Bronze



## OPP2

Marmo nero Marquinia  
Marquinia black marble  
Marmor Marquinia schwarz  
Marbre noir Marquinia



## OPP15

Marmo Bianco Covelano  
Covelano white marble  
Marmor Covelano weiss  
Marbre blanc Covelano



## OPP3

Marmo Emperador marrone  
Emperador brown marble  
Marmor Emperador braun  
Marbre brun Emperador



## OPP16

Marmo Sahara nero  
Sahara noir marble  
Marmor Sahara noir  
Marbre Sahara noir

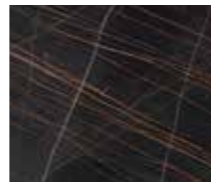

## OPP7

Marmo Calacatta oro  
Calacatta gold marble  
Marmor Calacatta gold  
Marbre Calacatta or



## OPP17

Marmo Port Laurent  
Port Laurent marble  
Marmor Port Laurent  
Marbre Port Laurent



## OPP9

Marmo Black and gold  
Black and gold marble  
Marmor Black and gold  
Marbre Black and gold

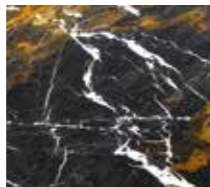

## OPP18

Marmo Arabescato Vagli  
Arabescato Vagli marble  
Marmor Arabescato Vagli  
Marbre Arabescato Vagli



## OPP10

Marmo Perfetto brown  
Perfetto brown marble  
Marmor Perfetto braun  
Marbre brun Perfetto



## OPP19

Marmo Calacatta Vagli  
Calacatta Vagli marble  
Marmor Calacatta Vagli  
Marbre Calacatta Vagli



## OPP11

Marmo Grey Stone  
Grey Stone marble  
Marmor Grey Stone  
Marbre Grey Stone



## OPP20

Marmo Arabescato grigio orobico  
Arabescato orobico grey marble  
Marmor arabescato orobico grau  
Marbre arabescato orobico gris



## OPP12

Marmo Verde Guatemala  
Guatemala green marble  
Marmor Guatemala grün  
Marbre vert Guatemala



## OPP21

Marmo Calacatta viola  
Calacatta violet marble  
Marmor Calacatta violett  
Marbre Calacatta violett



# Finiture pietre

STONES FINISHES

335

LIFESTYLE COLLECTION 2021 \_ MARELLI

## OPP4

Pietra Serena grigia  
Grey Serena stone  
Grauer Serena Stein  
Pierre grise Serena



## OPP5

Pietra di Brera beige  
Beige Brera stone  
Beige Brera Stein  
Pierre beige Brera

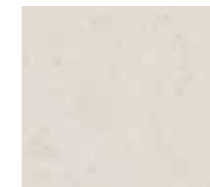

## OPG2 Nero Marquinia



## OPG3 Statuario Select



## OPG4 Calacatta Royal



## OPG5 Bianco Dolomite



# Schede tecniche

TECHNICAL INFORMATION

# Alexander

DESIGN  
STUDIO MARELLI  
2021

338

LIFESTYLE COLLECTION 2021 \_ MARELLI

Fusto in legno massello e legno multistrato con cinghie elastiche intrecciate. Imbottitura in poliuretano espanso rivestito in vellutino bianco.

Cuscini di schienale in piuma.\*

Cuscini di seduta costituiti da un inserto in poliuretano con densità di 30 Kg/m<sup>3</sup> ricoperto da un trapuntino di vera piuma imbottito a scomparti\*. Completamente sfoderabile in tessuto, non sfoderabile in pelle e finta pelle.

Kit letto non disponibile.

\*Manutenzione dei cuscini contenenti piuma:

I cuscini contenenti piuma tendono a deformarsi con l'utilizzo. Per mantenerne la forma è necessario, anche dopo un breve utilizzo, battere e primacciare ripetutamente i cuscini. Non utilizzare mai battipanni o aspirapolvere. A coloro che non desiderassero seguire queste indicazioni o che volessero un divano dall'aspetto meno vissuto, raccomandiamo di preferire dei cuscini in gomma.

*Carcase en bois massif et multiplis muni de bandes élastiques entrecroisées et finie de mousse polyuréthane couverte de dacron.*

*Coussins de dossier en plume\**

*Les coussins d'assise sont composés d'un noyau en mousse polyuréthane d'une densité de 30 kg/m<sup>3</sup> couvert de véritable duvet broché en compartiments\*. Revêtement complètement déhoussable en tissu, fixe en cuir et cuir look.*

*Pas disponible en canapé-lit.*

*\*Entretien de coussins en duvet:*

*Coussins en duvet ont tendance à perdre leur forme dû à l'usage. Pour en conserver la forme il est nécessaire, aussi après un usage court, de régulièrement battre les coussins. Ne jamais utiliser la tapette ou l'aspirateur.*

*À ceux qui ne désirent pas suivre ces indications ou qui souhaitent un canapé qui ait l'air moins "usé", nous conseillons vivement de choisir des coussins en mousse polyuréthane.*

*Frame made of solid wood and multi-ply wood with interwoven elastic straps. The upholstery is made of polyurethane foam, covered with dacron.*

*The back cushions are filled with feathers\**

*The seat cushions are made of a foam insert with density of 30 Kg/m<sup>3</sup>, covered with a feather compartments quilt\*. Fully removable fabric covers, fixed leather and artificial leather covers. Sofa-bed is not available.*

*\*Maintenance of feather cushions:*

*Cushions filled with feathers tend to change their shape with use. In order to keep their shape it is necessary, even after a short use, to plump up the cushions repeatedly. Never use carpet beater or vacuum cleaner. We recommend to choose foam cushions to those who do not wish to follow these instructions or to have a "used look" sofa.*

*Для производства каркаса используется массив дерева и многослойная фанера в сочетании с перекрещивающимися эластичными ремнями.*

*Подушки спинки в пуху.\**

*Подушки сиденья: стеганные по отсекам, наполнение из натурального пуха с вставками из полиуретана плотностью 30 кг/м<sup>3</sup>.\**

*Полностью съемные чехлы из ткани, несъемные чехлы из кожи.*

*Вариант со спальным местом не предусмотрен.*

*Das Gestell besteht aus Massiv- und Schichtholz, mit geflochtenen Gummigurten, gepolstert mit Polyurethanschaumstoff, mit Dacron bezogen.*

*Rueckenkissen in Daunen\**

*Die Sitzkissen bestehen aus einem Schaumkern mit Dichte 30 Kg/m<sup>3</sup> mit einer gekammerten Daunenauflege\*. Stoffbezüge alle abziehbar, Leder und Kunstleder festbezogen. Als Bettsofa nicht verfügbar. Wartungsanleitungen fuer Daunenkissen:*

*Die Kissen, die Daunen enthalten, neigen dazu, sich durch Gebrauch zu verformen. Um die ursprüngliche Form zu halten, ist es notwendig, auch nach kurzem Gebrauch, die Kissen wiederholt aufzuschütteln. Keinen Ausklopfen oder Staubsauger verwenden. Unseren Kunden, die diese Anweisungen nicht befolgen moechten, oder die kein Sofa mit solchem "gebrauchten" Aussehen haben moechten, empfehlen wir Polyurethan-Kissen.*

*\*Эксплуатация подушек с пуховым наполнением:*

*В процессе эксплуатации подушки с пуховым наполнением могут деформироваться, во избежание чего их необходимо слегка взбивать вручную даже после непродолжительного нахождения на диване. Использование в этих целях пылесоса или выбивалки для одежды категорически запрещено. Если клиент не планирует следовать данным инструкциям и хочет, чтобы подушки сиденья и спинки проминались по минимуму, посоветуйте выбрать наполнение только из полиуретана, полностью исключив натуральный пух.*

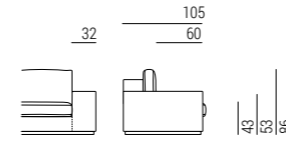

Divani  
Sofas

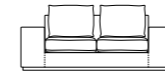

9ALX201  
L200 P105 H86



9ALX202  
L240 P105 H86



9ALX203  
L280 P100 H62

Elementi componibili  
Modular elements



9ALX301  
L100 P105 H86



9ALX302  
L120 P105 H86



9ALX303  
L140 P105 H86



9ALX304  
L70 P105 H86



9ALX305  
L90 P105 H86



9ALX306  
L110 P105 H86

Elemento angolare  
Corner element

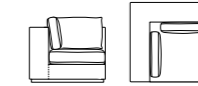

9ALX307  
L105 P105 H86



9ALX204  
L90 P90 H43

Dormeuse  
Longchair

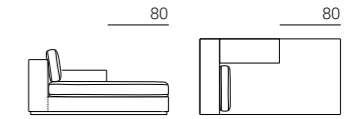

9ALX205  
L120 P186 H86

Accessori  
Accessories

Cuscino in piuma  
senza fascia  
Feather back cushion  
without band



9CU105  
L50 P50

Cuscino in piuma  
senza fascia  
Feather back cushion  
without band



9CU106  
L45 P45

Cuscino in piuma  
senza fascia  
Feather back cushion  
without band



9CU104  
L60 P60

# Alexander

DESIGN  
STUDIO MARELLI  
2021

339

LIFESTYLE COLLECTION 2021 \_ MARELLI

Tavoli  
Tables

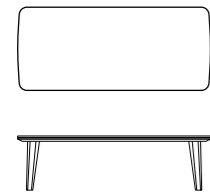

**TAND101**  
Top in grès porcellanato  
Porcelain stoneware top  
Base in legno  
Wooden base  
L255 P110 H71,5

Top: Gres Porcellanato, spessore 12 mm  
Top: Porcelain Stoneware, 12 mm thick



## Finiture/Finishes

Top in Gres Porcellanato  
Porcelain Stoneware Top



<b>Code</b>	Nero Marquina <b>OPG2</b>	Statuario Select <b>OPG3</b>	Calacatta Royal <b>OPG4</b>	Bianco Dolomite <b>OPG5</b>
-------------	------------------------------	---------------------------------	--------------------------------	--------------------------------

Base in legno  
Wooden base



<b>Code</b>	Cherry stained oak <b>OPR1</b>	Wengé stained oak <b>OPR2</b>	Walnut stained oak <b>OPR3</b>	Natural oak <b>OPR4</b>	Black stained oak <b>OPR5</b>	Cherry Milano stained oak <b>OPR6</b>
-------------	-----------------------------------	----------------------------------	-----------------------------------	----------------------------	----------------------------------	--



<b>Code</b>	Tobacco stained oak <b>OPR8</b>	Grey taupe stained oak <b>OPR9</b>	Whitened oak <b>OPR10</b>	Charcoal stained oak <b>OPR11</b>	Mahogany stained oak <b>OPR12</b>	Moka matt stained oak <b>OPR15</b>
-------------	------------------------------------	---------------------------------------	------------------------------	--------------------------------------	--------------------------------------	---------------------------------------

Caratteristica del modello è la tipica lavorazione a "trapuntatura" fatta a mano. Struttura: legno massello e pannelli multistrato rivestiti in poliuretano espanso e dacron. Seduta: imbottitura in poliuretano espanso a quote differenziate di 30 e 40 kg/mc, rivestita con fibre termolegate. Schienale: imbottitura in poliuretano espanso a quote differenziate di 30 e 40 kg/mc, rivestita con fibre termolegate. Rivestimento non sfoderabile.

Die Besonderheit von diesem Modell ist die typische abgesteppte Ausführung, völlig handgetun. Gestell: Massivholz und Multischichtplatten, von Schaumstoff-Polyurethane und Dacron bezogen. Sitzfläche: Polsterung aus unterschiedlich dichtem Schaumstoff-Polyurethane, Dichte 30 und 40 Kg/m<sup>3</sup>, in thermogebundenen Fasern bezogen. Rückenlehne: Polsterung aus unterschiedlich dichtem Schaumstoff-Polyurethane, Dichte 30 und 40 Kg/m<sup>3</sup>, in thermogebundenen Fasern bezogen. Bezug: nicht abziehbar.

The peculiarity of this model is the typical "quilting" manufacturing, all handmade. Frame: solid wood and multilayer panels covered in polyurethane foam and dacron. Seat: padding in polyurethane foam, in differentiated densities of 30 and 40 Kg/m<sup>3</sup>, covered with thermobound fibres. Back: padding in polyurethane foam in differentiated densities of 30 and 40 Kg/m<sup>3</sup>, covered with thermobound fibres. Cover: not removable

Главная отличительная особенность данной модели это прошивка по отсекам, сделанная вручную. Каркас: массив дерева в сочетании с многослойной фанерой, пенополиуретан, дакрон. Сиденье: наполнение из пенополиуретана различной плотности, 30 и 40 кг/м<sup>3</sup>, с покрытием из термосвязанных волокон. Спинка: наполнение из пенополиуретана различной плотности, 30 и 40 кг/м<sup>3</sup> с покрытием из термосвязанных волокон. Чехлы: несъемные

La particularité de ce modèle est la typique finition piquée toute faite à main. Structure: bois massif et panneaux multicouche recouverts de polyuréthane expansé et dacron. Assise: rembourrage de polyuréthane expansé avec densités différenciées, densité 30 et 40 Kg/m<sup>3</sup> recouverts de fibres thermoliées. Dossier: rembourrage de polyuréthane expansé avec densités différenciées, densité 30 et 40 Kg/m<sup>3</sup> recouverts de fibres thermoliées. Revêtement: pas déhoussable

## Finiture base Base finishes



<b>Code</b>	Shiny chrome metal <b>OPM1</b>	Brushed matt chrome metal <b>OPM2</b>	Brushed matt dark grey metal <b>OPM3</b>	RAL 9017 black painted metal <b>OPM6</b>	Classic bronze painted metal <b>OPM9</b>	Golden beach painted metal <b>OPM10</b>	Gold pearl painted metal <b>OPM11</b>
-------------	-----------------------------------	--	---	---	---	--	--



<b>Code</b>	Brushed copper metal <b>OPM12</b>	Brushed antique brass metal <b>OPM13</b>	Shiny black chrome metal <b>OPM14</b>	Brushed antique gold metal <b>OPM15</b>	Anodyc Bronze metal <b>OPM18</b>
-------------	--------------------------------------	---	--	--	-------------------------------------

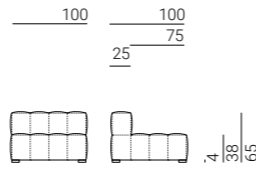

Elementi di seduta  
*Seat elements*

Elementi laterali con schienale e bracciolo  
*Corner elements with backrest and armrest*



**9AD103**  
L100 P100 H65

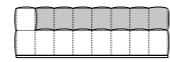

**9AD132**  
L200 P100 H65

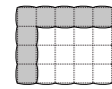
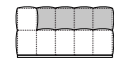

**9AD124**  
L125 P100 H65

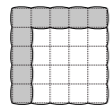

**9AD125**  
L125 P125 H65

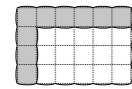
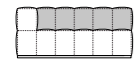

**9AD126**  
L150 P100 H65

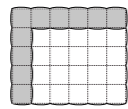

**9AD127**  
L150 P125 H65

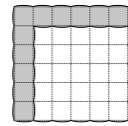

**9AD128**  
L150 P150 H65

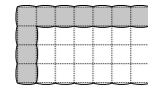
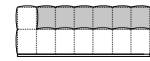

**9AD129**  
L175 P100 H65

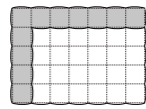

**9AD130**  
L175 P125 H65

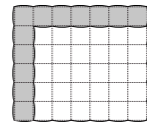

**9AD131**  
L175 P150 H65

Elementi di seduta  
*Seat elements*

Elementi centrali con schienale  
*Central elements with backrest*



**9AD104**  
L75 P100 H65



**9AD102**  
L100 P100 H65



**9AD113**  
L100 P125 H65



**9AD114**  
L100 P150 H65



**9AD200**  
L100 P100 H65



**9AD200**  
L100 P100 H65

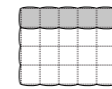

**9AD115**  
L125 P100 H65

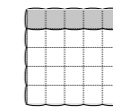

**9AD116**  
L125 P125 H65

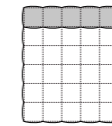

**9AD117**  
L125 P150 H65

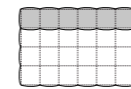
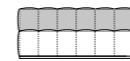

**9AD118**  
L150 P100 H65

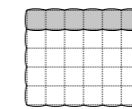

**9AD119**  
L150 P125 H65

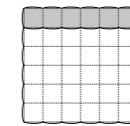

**9AD120**  
L150 P150 H65

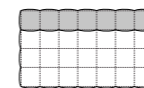

**9AD121**  
L175 P100 H65

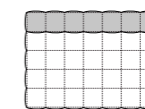

**9AD122**  
L175 P125 H65

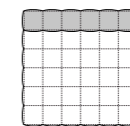

**9AD123**  
L175 P150 H65

Pouf  
Ottomans

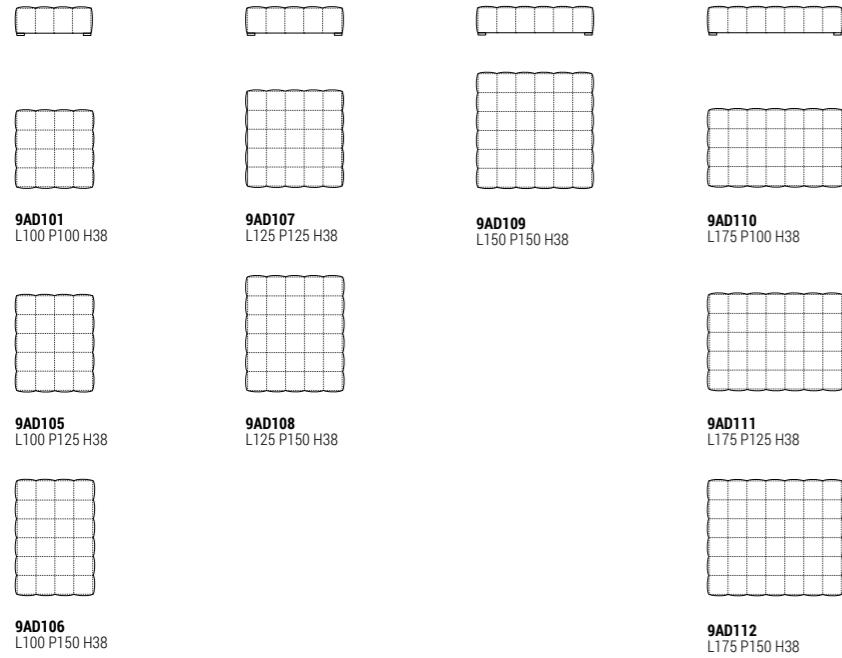

Dormeuse  
Longchair

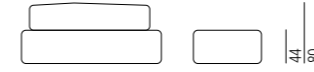
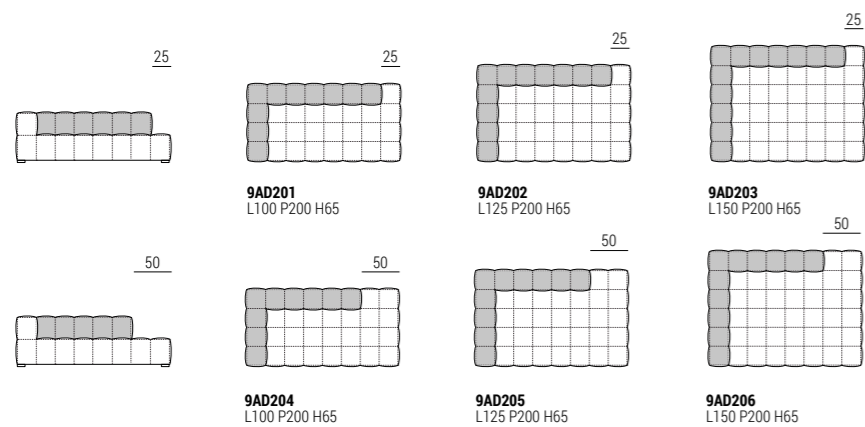

Fusto in legno massello e multistrato rivestito in poliuretano espanso a quote differenziate 30 kg/m<sup>3</sup> e 40 kg/m<sup>3</sup> e dacron.  
Rivestimento fisso non sfoderabile.

Carcasse en bois massif et multiplis finie de mousse polyuréthane de différentes densités de 30 kg/m<sup>3</sup> et 40 kg/m<sup>3</sup>, couverte de dacron.  
Le revêtement est toujours fixe.

Frame made of solid wood and multi-ply wood, upholstered with polyurethane foam in different densities of 30 kg/m<sup>3</sup> and 40 kg/m<sup>3</sup> and covered with dacron.  
Fixed covers.

Каркас из массива дерева и фанеры покрыт пенополиуретаном различной плотности 30 кг / м<sup>3</sup> и 40 кг / м<sup>3</sup> и дакрон.  
Неподвижная крышка не снимается.

Das Gestell besteht aus Massiv- und Schichtholz, gepolstert mit Polyurethanschaumstoff in verschiedenen Dichten 30 Kg/m<sup>3</sup> und 40 Kg/m<sup>3</sup>, mit Dacron ummantelt.  
Atacama ist immer festbezogen.

Divani  
Sofas

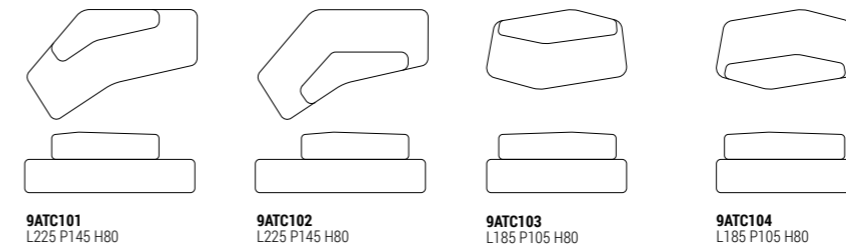

Pouf e accessori  
Ottomans and accessoires

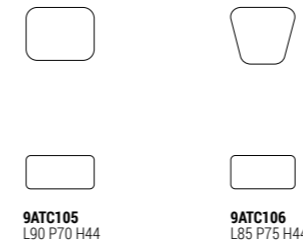

# Atene

DESIGN  
LUCA ERBA  
2021

346

LIFESTYLE COLLECTION 2021 \_ MARELLI

## Tavoli Tables

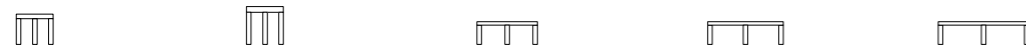
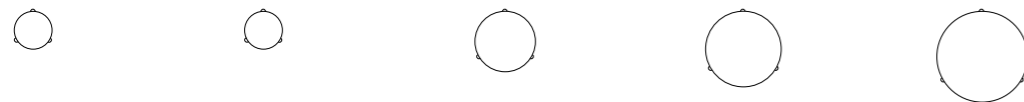

- |  |  |  |   |   |
|--|--|--|---|---|
| <b>7AT101</b><br>Top marmo/Marble top<br><b>7AT111</b><br>Top vetro/Glass top<br>ø50 H40 | <b>7AT102</b><br>Top marmo/Marble top<br><b>7AT112</b><br>Top vetro/Glass top<br>ø50 H50 | <b>7AT103</b><br>Top marmo/Marble top<br><b>7AT113</b><br>Top vetro/Glass top<br>ø80 H30 | <b>7AT104</b><br>Top marmo/Marble top<br><b>7AT114</b><br>Top vetro/Glass top<br>ø100 H30 | <b>7AT105</b><br>Top marmo/Marble top<br><b>7AT115</b><br>Top vetro/Glass top<br>ø120 H30 |
|--|--|--|---|---|

## Finiture Finishes

Top in marmo  
Marble top



- |             |                                     |                                      |                                       |                                  |                                  |                                      |                                      |                                       |                                   |  |
|-------------|-------------------------------------|--------------------------------------|---------------------------------------|----------------------------------|----------------------------------|--------------------------------------|--------------------------------------|---------------------------------------|-----------------------------------|--|
| <b>Code</b> | White Carrara marble<br><b>OPP1</b> | Black Marquina marble<br><b>OPP2</b> | Brown Emperador marble<br><b>OPP3</b> | Grey Serena stone<br><b>OPP4</b> | Beige Brera stone<br><b>OPP5</b> | Calacatta gold marble<br><b>OPP7</b> | Black and gold marble<br><b>OPP9</b> | Perfetto brown marble<br><b>OPP10</b> | Grey Stone marble<br><b>OPP11</b> | Guatemala green marble<br><b>OPP12</b> |
|-------------|-------------------------------------|--------------------------------------|---------------------------------------|----------------------------------|----------------------------------|--------------------------------------|--------------------------------------|---------------------------------------|-----------------------------------|--|

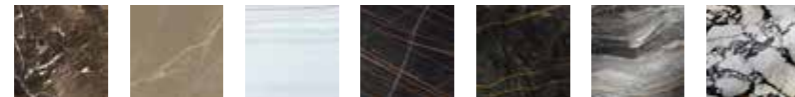

- |             |                                     |                                     |                                       |                                    |                                     |  |   |
|-------------|-------------------------------------|-------------------------------------|---------------------------------------|------------------------------------|-------------------------------------|--|---|
| <b>Code</b> | Velvet brown marble<br><b>OPP13</b> | Amani Bronze marble<br><b>OPP14</b> | Covelano white marble<br><b>OPP15</b> | Sahara noir marble<br><b>OPP16</b> | Port Laurent marble<br><b>OPP17</b> | Arabescato orobico grey marble<br><b>OPP20</b> | Calacatta violet marble<br><b>OPP21</b> |
|-------------|-------------------------------------|-------------------------------------|---------------------------------------|------------------------------------|-------------------------------------|--|---|

Top in vetro  
Glass top



- |             |  |  |  |   |   |  |
|-------------|--|--|--|---|---|--|
| <b>Code</b> | RAL 9016 traffic white back-painted glass<br><b>OPV3</b> | RAL 9017 traffic black back-painted glass<br><b>OPV4</b> | RAL 7044 silk grey back-painted glass<br><b>OPV5</b> | RAL 1019 grey beige back-painted glass<br><b>OPV6</b> | Chrome back-painted bronze glass<br><b>OPV9</b> | Chrome back-painted grey glass<br><b>OPV10</b> |
|-------------|--|--|--|---|---|--|

Base in metallo  
Metal Base



- |             |                                   |  |   |   |   |   |  |  |
|-------------|-----------------------------------|--|---|---|---|---|--|--|
| <b>Code</b> | Shiny chrome metal<br><b>OPM1</b> | Brushed matt chrome metal<br><b>OPM2</b> | Brushed matt dark grey metal<br><b>OPM3</b> | RAL 9017 black painted metal<br><b>OPM6</b> | RAL 9016 white painted metal<br><b>OPM7</b> | Classic bronze painted metal<br><b>OPM9</b> | Golden beach painted metal<br><b>OPM10</b> | Gold pearl painted metal<br><b>OPM11</b> |
|-------------|-----------------------------------|--|---|---|---|---|--|--|



- |             |                                      |   |  |  |  |                              |                                     |
|-------------|--------------------------------------|---|--|--|--|------------------------------|-------------------------------------|
| <b>Code</b> | Brushed copper metal<br><b>OPM12</b> | Brushed antique brass metal<br><b>OPM13</b> | Shiny black chrome metal<br><b>OPM14</b> | Brushed antique gold metal<br><b>OPM15</b> | Shiny brass chrome metal<br><b>OPM16</b> | Bronze metal<br><b>OPM17</b> | Anodyc bronze metal<br><b>OPM18</b> |
|-------------|--------------------------------------|---|--|--|--|------------------------------|-------------------------------------|

# Break

DESIGN  
STUDIO MARELLI  
2009

347

LIFESTYLE COLLECTION 2021 \_ MARELLI

## Tavoli Tables



- |   |   |   |   |
|---|---|---|---|
| <b>7BR101</b><br>Top marmo/Marble top<br><b>7BR104</b><br>Top MDF/MDF top<br><b>7BR111</b><br>Top legno/Wooden top<br><b>7BR117</b><br>Top vetro/Glass top<br><b>7BR114</b><br>Top metallo/Metal top<br>ø40 H45 | <b>7BR102</b><br>Top marmo/Marble top<br><b>7BR105</b><br>Top MDF/MDF top<br><b>7BR112</b><br>Top legno/Wooden top<br><b>7BR118</b><br>Top vetro/Glass top<br><b>7BR115</b><br>Top metallo/Metal top<br>ø60 H36 | <b>7BR103</b><br>Top marmo/Marble top<br><b>7BR106</b><br>Top MDF/MDF top<br><b>7BR113</b><br>Top legno/Wooden top<br><b>7BR119</b><br>Top vetro/Glass top<br><b>7BR116</b><br>Top metallo/Metal top<br>ø80 H27 | <b>7BR120</b><br>Top marmo/Marble top<br><b>7BR121</b><br>Top MDF/MDF top<br><b>7BR122</b><br>Top legno/Wooden top<br><b>7BR123</b><br>Top vetro/Glass top<br><b>7BR124</b><br>Top metallo/Metal top<br>L90 P60 H28 |
|---|---|---|---|

Top: marmo/rovere massello/MDF, spessore 20 mm  
Base: metallo, spessore 10 mm  
Top: marble/solid oak/MDF, 20 mm thick  
Base: metal, 10 mm thick

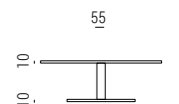
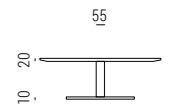

Top: metallo, spessore 10 mm  
Base: metallo, spessore 10 mm  
Top: metal, 10 mm thick  
Base: metal, 10 mm thick

## Finiture/Finishes

Top in marmo Marble top											
<b>Code</b>	White Carrara marble <b>OPP1</b>	Black Marquina marble <b>OPP2</b>	Brown Emperador marble <b>OPP3</b>	Grey Serena stone <b>OPP4</b>	Beige Brera stone <b>OPP5</b>	Calacatta gold marble <b>OPP7</b>	Black and gold marble <b>OPP9</b>	Perfetto brown marble <b>OPP10</b>	Grey Stone marble <b>OPP11</b>	Guatemala green marble <b>OPP12</b>	
<b>Code</b>	Velvet brown marble <b>OPP13</b>	Amani Bronze marble <b>OPP14</b>	Covelano white marble <b>OPP15</b>	Sahara noir marble <b>OPP16</b>	Port Laurent marble <b>OPP17</b>	Arabescato orobico grey marble <b>OPP20</b>	Calacatta violet marble <b>OPP21</b>				
Top in Gres Porcellanato Porcelain Stoneware Top											
<b>Code</b>	Nero Marquina <b>OPG2</b>	Statuario Select <b>OPG3</b>	Calacatta Royal <b>OPG4</b>	Bianco Dolomite <b>OPG5</b>							
Top in rovere massello Solid oak top											
<b>Code</b>	Cherry stained oak <b>OPR1</b>	Wengé stained oak <b>OPR2</b>	Walnut stained oak <b>OPR3</b>	Natural oak <b>OPR4</b>	Black stained oak <b>OPR5</b>	Cherry Milano stained oak <b>OPR6</b>					
<b>Code</b>	Tobacco stained oak <b>OPR8</b>	Grey taupe stained oak <b>OPR9</b>	Whitened oak <b>OPR10</b>	Charcoal stained oak <b>OPR11</b>	Mahogany stained oak <b>OPR12</b>	Moka matt stained oak <b>OPR15</b>					
Base/top in metallo Metal base/top											
<b>Code</b>	Shiny chrome metal <b>OPM1</b>	Brushed matt dark grey metal <b>OPM2</b>	Brushed matt dark grey metal <b>OPM3</b>	RAL 9016 black painted metal <b>OPM6</b>	RAL 9016 white painted metal <b>OPM7</b>	Classic bronze painted metal <b>OPM9</b>	Golden beach painted metal <b>OPM10</b>	Gold pearl painted metal <b>OPM11</b>	Brushed copper metal <b>OPM12</b>	Brushed antique brass metal <b>OPM13</b>	
<b>Code</b>	Shiny black chrome metal <b>OPM14</b>	Brushed antique gold metal <b>OPM15</b>	Shiny brass chrome metal <b>OPM16</b>	Bronze metal <b>OPM17</b>	Anodyc Bronze metal <b>OPM18</b>						
Top in MDF MDF top											
	RAL 9017 traffic black painted MDF		RAL 9016 traffic white painted MDF								

## Tavoli Tables

				<p>Top: marmo/rovere massello/MDF, spessore 20 mm Base: metallo, spessore 10 mm Top: marmo/solid oak/MDF, 20 mm thick Base: metal, 10 mm thick</p>
<p><b>7BR201</b> Top marmo/Marble top <b>7BR205</b> Top legno/Wooden top ø100 H74</p>	<p><b>7BR202</b> Top marmo/Marble top <b>7BR206</b> Top legno/Wooden top ø110 H74</p>	<p><b>7BR203</b> Top marmo/Marble top <b>7BR207</b> Top legno/Wooden top ø120 H74</p>	<p><b>7BR204</b> Top marmo/Marble top <b>7BR208</b> Top legno/Wooden top ø110 H100</p>	
	<p><b>7BR220</b> Top marmo/Marble top <b>7BR221</b> Top legno/Wooden top <b>7BR221</b> Top vetro/Glass top ø190 H74</p>			



# Break Dining Table

DESIGN  
STUDIO MARELLI  
2009

# Brera

DESIGN  
PAOLO SALVADÉ  
2021

350

LIFESTYLE COLLECTION 2021 \_ MARELLI

## Finiture Finishes

Top in marmo Marble top										
Code	White Carrara marble <b>OPP1</b>	Black Marquinia marble <b>OPP2</b>	Brown Emperador marble <b>OPP3</b>	Calacatta gold marble <b>OPP7</b>	Black and gold marble <b>OPP9</b>	Perfetto brown marble <b>OPP10</b>	Grey Stone marble <b>OPP11</b>	Guatemala green marble <b>OPP12</b>	Velvet brown marble <b>OPP13</b>	Amani Bronze marble <b>OPP14</b>
Code	Covelano white marble <b>OPP15</b>	Sahara noir marble <b>OPP16</b>	Port Laurent marble <b>OPP17</b>	Arabescato orobico grey marble <b>OPP20</b>	Calacatta violet marble <b>OPP21</b>					
Top in Gres Porcellanato Porcelain Stoneware Top										
Code	Nero Marquinia <b>OPG2</b>	Statuario Select <b>OPG3</b>	Calacatta Royal <b>OPG4</b>	Bianco Dolomite <b>OPG5</b>						
Base in metallo Metal base										
Code	Shiny chrome metal <b>OPM1</b>	Brushed matt chrome metal <b>OPM2</b>	Brushed matt dark grey metal <b>OPM3</b>	RAL 9017 black painted metal <b>OPM6</b>	RAL 9016 white painted metal <b>OPM7</b>	Classic bronze painted metal <b>OPM9</b>	Golden beach painted metal <b>OPM10</b>	Gold pearl painted metal <b>OPM11</b>	Brushed copper metal <b>OPM12</b>	Brushed antique brass metal <b>OPM13</b>
Code	Shiny black chrome metal <b>OPM14</b>	Brushed antique gold metal <b>OPM15</b>	Shiny brass chrome metal <b>OPM16</b>	Bronze metal <b>OPM17</b>	Anodic Bronze metal <b>OPM18</b>					

Struttura in tubolare di metallo ricoperto con schiuma di poliuretano a freddo ignifugo, classe 1IM, rivestito con una fodera in fibra acrilica. Cuscino di seduta in poliuretano espanso con densità 40 kg/m<sup>3</sup> (5,9 KPA), rivestito in fibra acrilica.  
Il rivestimento è sempre fisso.

Structure en métal tubulaire recouvert de mousse à froid ignifuge classe 1IM, recouverte d'une housse en fibre acrylique. Coussin d'assise en mousse de polyuréthane avec une densité de 40 kg/m<sup>3</sup> (5,9 kPa), recouverte de fibre acrylique.  
Le revêtement est toujours fixe.

Metal tube structure upholstered with cold injected fire retardant polyurethane foam class 1IM, covered with acrylic fibre. Seat cushion in polyurethane foam with density 40 kg/m<sup>3</sup> (5,9 KPA), lined with acrylic fibre.  
Fixed covers.

Каркас выполнен из профильной металлической трубы, покрытой слоем огнестойкого пенополиуретана холодного формования, класс 1 IM, и помещенной в чехол из акрилового волокна. Наполнение подушки сиденья выполнено из вспененного полиуретана плотностью 40 кг/м<sup>3</sup> (5,9 кПа), помещенного в чехол из акрилового волокна. Обивка только несъемная.

Struktur der Sitzschale in Metall überschäumt mit Polyurethan-Kaltschaumstoff, Feuerwiderstandsklasse 1IM, mit Acrylfaser ummantelt. Sitzkissen aus Polyurethan-Schaumstoff mit Dichte 40 Kg/m<sup>3</sup> (5,9 KPA), mit Acrylfaser ummantelt.  
Bezüge immer fix, nicht abziehbar.

351

LIFESTYLE COLLECTION 2021 \_ MARELLI

# Brera

DESIGN  
PAOLO SALVADÈ  
2021

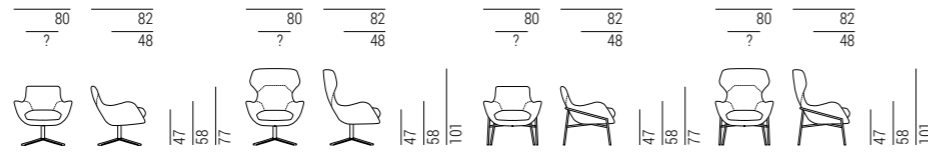

Poltrone  
Armchairs



**9BRE101**  
L80 P82 H77  
Swivel metal base



**9BRE102**  
L80 P82 H77  
Wood base



**9BRE103**  
L80 P82 H77  
Metal base



**9BRE104**  
L80 P82 H101  
Swivel metal base



**9BRE105**  
L80 P82 H101  
Wood base



**9BRE106**  
L80 P82 H101  
Metal base

Finiture  
Finishes

Base in metallo  
Metal base



**Code**

Shiny chrome metal **OPM1** | Brushed matt chrome metal **OPM2** | Brushed matt dark grey metal **OPM3** | RAL 9017 black painted metal **OPM6** | RAL 9016 white painted metal **OPM7** | Classic bronze painted metal **OPM9** | Golden beach painted metal **OPM10** | Gold pearl painted metal **OPM11** | Brushed copper metal **OPM12** | Brushed antique brass metal **OPM13**



**Code**

Shiny black chrome metal **OPM14** | Brushed antique gold metal **OPM15** | Shiny brass chrome metal **OPM16** | Bronze metal **OPM17** | Anodyc Bronze metal **OPM18**

Base in legno  
Wooden base



**Code**

Cherry stained oak **OPR1** | Wengé stained oak **OPR2** | Walnut stained oak **OPR3** | Natural oak **OPR4** | Black stained oak **OPR5** | Cherry Milano stained oak **OPR6**



**Code**

Tobacco stained oak **OPR8** | Grey taupe stained oak **OPR9** | Whitened oak **OPR10** | Charcoal stained oak **OPR11** | Mahogany stained oak **OPR12** | Moka matt stained oak **OPR15**

Base girevole in metallo  
Swivel metal base



**Code**

RAL 9017 black painted metal **OPM6** | Classic bronze painted metal **OPM9** | Golden beach painted metal **OPM10** | Gold pearl painted metal **OPM11** | Brushed antique gold metal **OPM15** | Anodyc Bronze metal **OPM18**

# Cassiopea

DESIGN  
MARCO CATTANEO  
2021

Tavoli  
Tables



**7CP101**  
Top marmo/Marble top  
**7CP111**  
Top vetro/Glass top  
ø42 H40



**7CP102**  
Top marmo/Marble top  
**7CP112**  
Top vetro/Glass top  
ø52 H50

Top: marmo spessore 20 mm  
Base: metallo, spessore 10 mm  
Top: marble 20 mm thick  
Base: metal, 10 mm thick

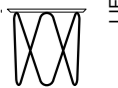

Finiture  
Finishes

Top in marmo  
Marble top



**Code**

White Carrara marble **OPP1** | Black Marquina marble **OPP2** | Brown Emperador marble **OPP3** | Grey Serena stone marble **OPP4** | Beige Brera stone marble **OPP5** | Calacatta gold marble **OPP7** | Black and gold marble **OPP9** | Perfetto brown marble **OPP10** | Grey Stone marble **OPP11** | Guatemala green marble **OPP12**

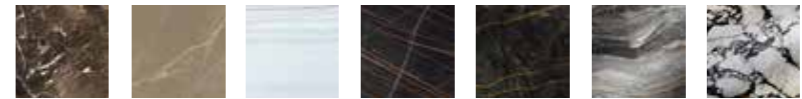

**Code**

Velvet brown marble **OPP13** | Amani Bronze marble **OPP14** | Covelano white marble **OPP15** | Sahara noir marble **OPP16** | Port Laurent marble **OPP17** | Arabescato orobico grey marble **OPP20** | Calacatta violet marble **OPP21**

Top in Gres Porcellanato  
Porcelain Stoneware Top

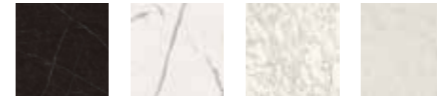

**Code**

Nero Marquina **OPG2** | Statuario Select **OPG3** | Calacatta Royal **OPG4** | Bianco Dolomite **OPG5**

Top in vetro  
Glass top



**Code**

RAL 9016 traffic white back-painted glass **OPV3** | RAL 9017 traffic black back-painted glass **OPV4** | RAL 7044 silk grey back-painted glass **OPV5** | RAL 1019 grey beige back-painted glass **OPV6** | Chrome back-painted bronze glass **OPV9** | Chrome back-painted grey glass **OPV10**

Base in metallo  
Metal base



**Code**

Brushed matt chrome metal **OPM2** | Brushed matt dark grey metal **OPM3** | RAL 9017 black painted metal **OPM6** | RAL 9016 white painted metal **OPM7** | Classic bronze painted metal **OPM9** | Golden beach painted metal **OPM10**



**Code**

Gold pearl painted metal **OPM11** | Brushed copper metal **OPM12** | Brushed antique brass metal **OPM13** | Brushed antique gold metal **OPM15** | Anodyc Bronze metal **OPM18**



Struttura in tubolare di metallo ricoperto con schiuma di poliuretano a freddo ignifugo, classe 11M. Cuscino di seduta con struttura in Baydur® 80IK28/DO con imbottitura in poliuretano espanso con densità 40 kg/m³ (5,9 KPA), rivestito in fibra acrilica. Il rivestimento è sempre fisso. Il basamento girevole è in metallo a 4 razze. Basamento girevole in metallo disponibile in due versioni.

*Metal tube structure upholstered with cold injected fire retardant polyurethane foam class 11M. Seat cushion with structure in Baydur® 80IK28/DO upholstered with polyurethane foam with density of 40 kg/m³ (5,9 KPA), covered with acrylic fibre. Covers are always fixed. The metal swivel base is a 4-star base.*

*Struktur der Sitzschale in Metall überschäumt mit Polyurethan-Kaltschaumstoff, Feuerwiderstandsklasse 11M. Sitzkissen mit Gestell in Baydur® 80IK28/DO, gepolstert mit Polyurethanschaumstoff mit Dichte 40 Kg/m³ (5,9 KPA), mit Acrylfaser ummantelt. Bezüge immer fix, nicht abziehbar. Das Drehgestell ist in Metall, mit 4-Fusskreuz mit Standsäule. Das Drehgestell ist in Metall, in zwei Versionen erhältlich.*

*Structure en métal tubulaire recouvert de mousse à froid ignifuge classe 11M. Coussin d'assise avec structure en Baydur® 80IK28/DO, rembourré en mousse polyuréthane d'une densité de 40 kg/m³ (5,9 KPA), recouverte de fibre acrylique. Le revêtement est toujours fixe. Base pivotante en métal à 4 pieds. Base pivotante en métal disponible en deux versions.*

Каркас из металлического профиля, покрытого слоем огнеупорного пенополиуретана холодного отверждения класса 11M. Подушка сиденья имеет основу из Baydur® 80IK28/DO и наполнение из вспененного полиуретана плотностью 40 кг/м³ (5,9 Кпа), обернутого в акриловое волокно. Обивка подушки несъемная. Вращающееся металлическое основание имеет 4 опоры.

*Baydur® - полимерный материал, производимый концерном Bayer. Металлическая поворотная основа доступна в двух версиях.*

## Poltrone Armchairs



**9CHI103**  
L58 P53 H77  
Poltroncina girevole  
con base in metallo  
Swivel armchair with metal base



**9CHI104**  
L58 P53 H77  
Poltroncina con base in metallo  
Armchair with metal base



**9CHI105**  
L58 P53 H77  
Poltroncina con base in legno  
Armchair with woodbase



**9CHI106**  
L58 P60 H102  
Sgabello  
Barstools



**9CHI107**  
L58 P60 H93/112  
Sgabello  
Barstools

## Basi girevoli Swivel bases

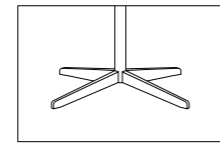

**Versione A** Base girevole  
in metallo a 4 razze  
**Version A** Swivel  
4-star metal base

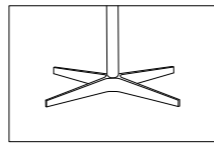

**Versione B** Base girevole  
in metallo a 4 razze  
**Version B** Swivel  
4-star metal base

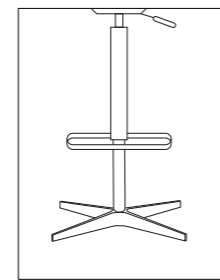

**Versione C** Base girevole  
in metallo a 4 razze  
**Version c** Swivel  
4-star metal base

## Finiture Finishes

<b>9CHI103</b> Base girevole in metallo A Swivel metal base A																				
<b>Code</b>	Shiny chrome metal <b>OPM1</b>	Brushed matt chrome metal <b>OPM2</b>	Brushed matt dark grey metal <b>OPM3</b>	RAL 9017 black painted metal <b>OPM6</b>	RAL 9016 white painted metal <b>OPM7</b>	Classic bronze painted metal <b>OPM9</b>	Golden beach painted metal <b>OPM10</b>													
<b>Code</b>	Gold pearl painted metal <b>OPM11</b>	Brushed copper metal <b>OPM12</b>	Brushed antique brass metal <b>OPM13</b>	Shiny black chrome metal <b>OPM14</b>	Brushed antique gold metal <b>OPM15</b>	Shiny brass chrome metal <b>OPM16</b>	Bronze metal <b>OPM17</b>	Anodized bronze painted metal <b>OPM18</b>												
<b>9CHI103</b> Base girevole in metallo B Swivel metal base B																				
<b>Code</b>	Shiny chrome metal <b>OPM1</b>	Brushed matt chrome metal <b>OPM2</b>	RAL 9017 black painted metal <b>OPM6</b>	Classic bronze painted metal <b>OPM9</b>																
<b>9CHI104</b> <b>9CHI106</b> base in metallo metal base																				
<b>Code</b>	Brushed matt chrome metal <b>OPM2</b>	Brushed matt dark grey metal <b>OPM3</b>	RAL 9017 black painted metal <b>OPM6</b>	RAL 9016 white painted metal <b>OPM7</b>	Classic bronze painted metal <b>OPM9</b>	Golden beach painted metal <b>OPM10</b>	Gold pearl painted metal <b>OPM11</b>	Brushed copper metal <b>OPM12</b>	Brushed antique brass metal <b>OPM13</b>	Brushed antique gold metal <b>OPM15</b>										
<b>9CHI105</b> Base in legno Wooden base																				
<b>Code</b>	Cherry stained oak <b>OPR1</b>	Wengé stained oak <b>OPR2</b>	Walnut stained oak <b>OPR3</b>	Natural oak <b>OPR4</b>	Black stained oak <b>OPR5</b>	Cherry Milano stained oak <b>OPR6</b>														
<b>Code</b>	Tobacco stained oak <b>OPR8</b>	Grey taupe stained oak <b>OPR9</b>	Whitened oak <b>OPR10</b>	Charcoal stained oak <b>OPR11</b>	Mahogany stained oak <b>OPR12</b>	Moka matt stained oak <b>OPR15</b>														

Tavoli  
Tables



**7CL101**  
Tavolino in metallo verniciato  
*Painted metal table*  
**7CL107**  
Tavolino in metallo con top in vetro  
*Metal table with glass top*  
**7CL116**  
Tavolino in metallo cromato  
o spazzolato  
*Chrome/Brushed metal table*  
**7CL124**  
Tavolino in metallo con top in marmo  
*Metal table with marble top*  
Ø60 H27



**7CL111**  
Tavolino in metallo verniciato  
*Painted metal table*  
**7CL121**  
Tavolino in metallo con top in vetro  
*Metal table with glass top*  
**7CL114**  
Tavolino in metallo cromato  
o spazzolato  
*Chrome/Brushed metal table*  
**7CL133**  
Tavolino in metallo con top in marmo  
*Metal table with marble top*  
Ø60 H40



**7CL102**  
Tavolino in metallo verniciato  
*Painted metal table*  
**7CL108**  
Tavolino in metallo con top in vetro  
*Metal table with glass top*  
**7CL117**  
Tavolino in metallo cromato  
o spazzolato  
*Chrome/Brushed metal table*  
**7CL125**  
Tavolino in metallo con top in marmo  
*Metal table with marble top*  
Ø40 H40



**7CL110**  
Tavolino in metallo verniciato  
*Painted metal table*  
**\* 7CL112**  
Tavolino in metallo con top in vetro  
*Metal table with glass top*  
**\* 7CL119**  
Tavolino in metallo cromato  
o spazzolato  
*Chrome/Brushed metal table*  
**\* 7CL127**  
Tavolino in metallo con top in marmo  
*Metal table with marble top*  
Ø100 H27



**7CL103**  
Tavolino in metallo verniciato  
*Painted metal table*  
**7CL109**  
Tavolino in metallo con top in vetro  
*Metal table with glass top*  
**7CL118**  
Tavolino in metallo cromato  
o spazzolato  
*Chrome/Brushed metal table*  
**7CL126**  
Tavolino in metallo con top in marmo  
*Metal table with marble top*  
Ø40 H50



**7CL113**  
Tavolino in metallo verniciato  
*Painted metal table*  
**\* 7CL115**  
Tavolino in metallo con top in vetro  
*Metal table with glass top*  
**\* 7CL120**  
Tavolino in metallo cromato  
o spazzolato  
*Chrome/Brushed metal table*  
**\* 7CL128**  
Tavolino in metallo con top in marmo  
*Metal table with marble top*  
Ø100 H40

\* Non realizzabili nelle finiture OPM1, OPM14, OPM16 e OPM17.  
\* Not available in the finishes OPM1, OPM14, OPM16 and OPM17.

Top: metallo, spessore 5 mm  
Base: metallo, spessore 5 mm  
*Top: metal, 5 mm thick*  
*Base: metal, 5 mm thick*



Top: vetro extra light temperato, spessore 6 mm  
Base: metallo spessore 5 mm  
*Top: extralight tempered glass, 6 mm thick*  
*Base: metal, 5 mm thick*



Top: marmo, spessore 20 mm  
Base: metallo, spessore 5 mm  
*Top: marble, 20 mm thick*  
*Base: metal, 5 mm thick*

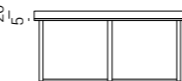

Finiture  
Finishes

Base in metallo  
cromato o spazzolato  
*Chrome or brushed  
metal base*



Shiny chrome metal  
**OPM1**    Brushed matt chrome metal  
**OPM2**    Brushed matt dark grey metal  
**OPM3**    Brushed copper metal  
**OPM12**    Brushed antique brass metal  
**OPM13**    Shiny black chrome metal  
**OPM14**    Brushed antique gold metal  
**OPM15**    Shiny brass chrome metal  
**OPM16**    Bronze metal  
**OPM17**

Base in metallo  
verniciato  
*Painted  
metal base*



RAL 9017 black painted metal  
**OPM6**    RAL 9016 white painted metal  
**OPM7**    Metal painted in RAL Classic colors  
**OPM8**    Classic bronze painted metal  
**OPM9**    Golden beach painted metal  
**OPM10**    Gold pearl painted metal  
**OPM11**    Anodyc. Bronze metal  
**OPM18**

Top in vetro  
*Glass top*



Transparent glass  
**OPV1**    Frosted glass  
**OPV2**    RAL 9016 traffic white back-painted glass  
**OPV3**    RAL 9017 traffic black back-painted glass  
**OPV4**    RAL 7044 silk grey back-painted glass  
**OPV5**    RAL 1019 grey beige back-painted glass  
**OPV6**



Glass back-painted in the RAL classic colours  
**OPV7**    Chrome back-painted bronze glass  
**OPV9**    Chrome back-painted grey glass  
**OPV10**    Transparent bronze glass  
**OPV12**    Transparent grey glass  
**OPV13**

Top in marmo  
*Marble top*



White Carrara marble  
**OPP1**    Black Marquina marble  
**OPP2**    Brown Emperador marble  
**OPP3**    Grey Serena stone  
**OPP4**    Beige Brera stone  
**OPP5**    Calacatta gold marble  
**OPP7**    Black and gold marble  
**OPP9**    Perfetto brown marble  
**OPP10**    Grey Stone marble  
**OPP11**    Guatemala green marble  
**OPP12**



Velvet brown marble  
**OPP13**    Amani Bronze marble  
**OPP14**    Covellano white marble  
**OPP15**    Sahara noir marble  
**OPP16**    Port Laurent marble  
**OPP17**    Arabescato orobico grey marble  
**OPP20**    Calacatta violet marble  
**OPP21**

Top in Gres Porcellanato  
*Porcelain Stoneware Top*



Nero Marquina  
**OPG2**    Statuario Select  
**OPG3**    Calacatta Royal  
**OPG4**    Bianco Dolomite  
**OPG5**

# Clipper

DESIGN  
STEFANO GALLIZOLI  
2019

358

LIFESTYLE COLLECTION 2021 \_ MARELLI

Schienale in legno multistrato di pioppo curvato imbottito con poliuretano espanso con densità 30 kg/m<sup>3</sup>. Seduta in legno multistrato di pioppo imbottito con poliuretano espanso con densità 40 kg/m<sup>3</sup>, rivestito in dacron con cinghie elastiche intrecciate. Rivestimento fisso.  
Il modello è disponibile senza piedini, con basamento in legno o in metallo. Le poltrone sono disponibili anche con basamento girevole in metallo.

*Dossier en bois multiplis de peuplier courbé fini de mousse de polyuréthane de densité de 30 kg/m<sup>3</sup>. Structure d'assise en bois multiplis de peuplier finie de mousse de polyuréthane de densité de 40 kg/m<sup>3</sup> couverte de dacron, muni de bandes élastiques entrecroisées.  
Le revêtement est toujours fixe.  
Le modèle est disponible sans piètement, avec piètement en bois ou en métal. Les fauteuils sont disponibles aussi avec base pivotante en métal.*

*Backrest made of curved multi-ply poplar wood, upholstered with polyurethane foam with density 30 kg/m<sup>3</sup>. Seat structure made of multi-ply poplar wood, upholstered with polyurethane foam with density 40 kg/m<sup>3</sup>, covered with dacron, with interwoven elastic belts. Fixed covers.  
The model is available without base, with wooden or metal base. The armchairs are also available also with swivel metal base.*

*Спинка: гнутая многослойная фанера из тополя в сочетании со вспененным полиуретаном плотностью 30кг/м<sup>3</sup>. Сиденье: гнутая многослойная фанера из тополя в сочетании со вспененным полиуретаном плотностью 40кг/м<sup>3</sup>, обернутым в дакрон. Подвеска из перекрещивающихся эластичных ремней. Обивка съёмная.  
Помимо ножек диван может иметь деревянное либо металлическое основание. Кресла могут иметь поворотное металлическое основание.*

*Rückenlehne aus gebogenem Pappelschichtholz, gepolstert mit Polyurethan-Schaumstoff mit Dichte 30 Kg/m<sup>3</sup>. Sitzstruktur aus Pappelschichtholz, gepolstert mit Polyurethan-Schaumstoff mit Dichte 40 Kg/m<sup>3</sup>, mit Dacron Ummantelt, mit gefrochtenen Gummigurten. Clipper ist immer festbezogen.  
Das Modell ist ohne Fussgestell, mit Fussgestell in Holz oder Metall erhältlich. Die Sessel sind auch mit Drehgestell in Metall lieferbar.*

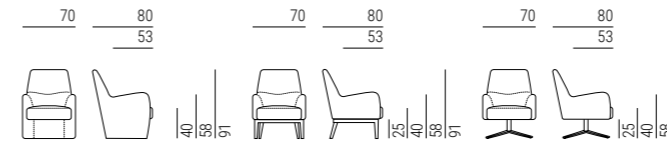

## HIGH BACK

Poltrone e divani  
Armchairs and Sofas



**9CLX101**  
L70 P80 H91



**9CLX102**  
L70 P80 H91  
Base in legno  
Wooden base



**9CLX103**  
L70 P80 H91  
Base in metallo  
Metal base



**9CLX104**  
L70 P80 H91  
Base metallo girevole  
Metal swivel base

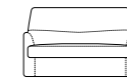

**9CLX201**  
L150 P80 H91

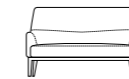

**9CLX203**  
L150 P80 H91  
Base in legno  
Wooden base

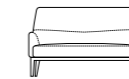

**9CLX205**  
L150 P80 H91  
Base in metallo  
Metal base

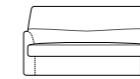

**9CLX202**  
L170 P80 H91

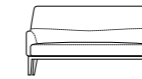

**9CLX204**  
L170 P80 H91  
Base in legno  
Wooden base

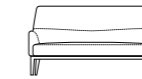

**9CLX206**  
L170 P80 H91  
Base in metallo  
Metal base

## Finiture Finishes

Base legno  
Wooden base



**Code** Cherry stained oak **OPR1** Wengé stained oak **OPR2** Walnut stained oak **OPR3** Natural oak **OPR4** Black stained oak **OPR5** Cherry Milano stained oak **OPR6**



**Code** Tobacco stained oak **OPR8** Grey taupe stained oak **OPR9** Whitened oak **OPR10** Charcoal stained oak **OPR11** Mahogany stained oak **OPR12** Moka matt stained oak **OPR15**

Base metallo  
Metal base



**Code** Shiny chrome metal **OPM1** Brushed matt chrome metal **OPM2** Brushed matt dark grey metal **OPM3** RAL 9017 black painted metal **OPM6** RAL 9016 white painted metal **OPM7** Classic bronze painted metal **OPM9**



**Code** Golden beach painted metal **OPM10** Gold pearl painted metal **OPM11** Brushed antique copper metal **OPM12** Brushed antique brass metal **OPM13** Shiny black chrome metal **OPM14** Brushed antique gold metal **OPM15** Shiny brass chrome metal **OPM16** Bronze metal **OPM17** Anodized Bronze painted metal **OPM18**

# Clipper

DESIGN  
STEFANO GALLIZOLI  
2019

359

LIFESTYLE COLLECTION 2021 \_ MARELLI

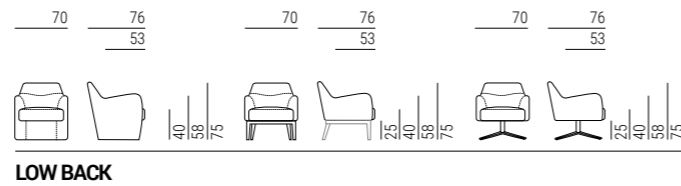

Poltrone e divani  
Armchairs and Sofas



**9CLX105**  
L70 P76 H75

**9CLX106**  
L70 P76 H75  
Base in legno  
Wooden base

**9CLX107**  
L70 P76 H75  
Base in metallo  
Metal base

**9CLX108**  
L70 P76 H75  
Base metallo girevole  
Metal swivel base



**9CLX207**  
L150 P76 H75

**9CLX209**  
L150 P76 H75  
Base in legno  
Wooden base

**9CLX211**  
L150 P76 H75  
Base in metallo  
Metal base



**9CLX208**  
L170 P76 H75

**9CLX210**  
L170 P76 H75  
Base in legno  
Wooden base

**9CLX212**  
L170 P76 H75  
Base in metallo  
Metal base

Finiture  
Finishes

Base legno  
Wooden base



**Code**

Cherry stained oak **OPR1**

Wengé stained oak **OPR2**

Walnut stained oak **OPR3**

Natural oak **OPR4**

Black stained oak **OPR5**

Cherry Milano stained oak **OPR6**



**Code**

Tobacco stained oak **OPR8**

Grey taupe stained oak **OPR9**

Whitened oak **OPR10**

Charcoal stained oak **OPR11**

Mahogany stained oak **OPR12**

Moka matt stained oak **OPR15**

Base metallo  
Metal base



**Code**

Shiny chrome metal **OPM1**

Brushed matt chrome metal **OPM2**

Brushed matt dark grey metal **OPM3**

RAL 9017 black painted metal **OPM6**

RAL 9016 white painted metal **OPM7**

Classic bronze painted metal **OPM9**



**Code**

Golden beach painted metal **OPM10**

Gold pearl painted metal **OPM11**

Brushed copper metal **OPM12**

Brushed antique brass metal **OPM13**

Shiny black chrome metal **OPM14**

Brushed antique gold metal **OPM15**

Shiny brass chrome metal **OPM16**

Bronze metal **OPM17**

Anodized Bronze painted metal **OPM18**

Fusto in legno massello e legno multistrato con cinghie elastiche intrecciate. Imbottitura in poliuretano espanso rivestito in vellutino bianco. Cuscini di schienale in Piumafib, una speciale miscela ipoallergenica di vera piuma e fibra poliestere siliconata\*. Cuscini di seduta costituiti da un inserto in poliuretano con densità di 30 Kg/m<sup>3</sup> ricoperto da un trapuntino di vera piuma imbottito a scomparti\*. Completamente sfoderabile in tessuto, non sfoderabile in pelle e finta pelle.

Kit letto non disponibile.  
\*Manutenzione dei cuscini contenenti piuma: I cuscini contenenti piuma tendono a deformarsi con l'utilizzo. Per mantenerne la forma è necessario, anche dopo un breve utilizzo, battere e sprimacciare ripetutamente i cuscini. Non utilizzare mai battipanni o aspirapolvere. A coloro che non desiderassero seguire queste indicazioni o che volessero un divano dall'aspetto meno vissuto, raccomandiamo di preferire dei cuscini in gomma.

*Carcasse en bois massif et multiplis muni de bandes élastiques entrecroisées et finie de mousse polyuréthane couverte de dacron. Coussins de dossier en Piumafib, un mélange hypoallergénique spécial de véritable duvet et fibre polyester siliconisée\*. Les coussins d'assise sont composés d'un noyau en mousse polyuréthane d'une densité de 30 kg/m<sup>3</sup> couvert de véritable duvet broché en compartiments\*. Revêtement complètement déhoussable en tissu, fixe en cuir et cuir look. Pas disponible en canapé-lit.*  
\*Entretien de coussins en duvet: Coussins en duvet ont tendance à perdre leur forme dû à l'usage. Pour en conserver la forme il est nécessaire, aussi après un usage court, de régulièrement battre les coussins. Ne jamais utiliser la tapette ou l'aspirateur. A ceux qui ne désirent pas suivre ces indications ou qui souhaitent un canapé qui ait l'air moins "usé", nous conseillons vivement de choisir des coussins en mousse polyuréthane.

Frame made of solid wood and multi-ply wood with interwoven elastic straps. The upholstery is made of polyurethane foam, covered with dacron. The back cushions are filled with Piumafib, a special hypoallergenic mixture of feathers and siliconised polyfibre\*. The seat cushions are made of a foam insert with density of 30 Kg/m<sup>3</sup>, covered with a feather compartments quilt\*. Fully removable fabric covers, fixed leather and artificial leather covers. Sofa-bed is not available.

\*Maintenance of feather cushions: Cushions filled with feathers tend to change their shape with use. In order to keep their shape it is necessary, even after a short use, to plump up the cushions repeatedly. Never use carpet beater or vacuum cleaner. We recommend to choose foam cushions to those who do not wish to follow these instructions or to have a "used look" sofa.

Для производства каркаса используется массив дерева и многослойная фанера в сочетании с перекрещивающимися эластичными ремнями. Наполнение из полиуретана, обернутого в белый бархат. Наполнение подушек спинки выполнено из материала Piumafib – специальной, не вызывающей аллергию смеси из натурального пуха и полиэфирных силиконовых волокон\*. Подушки сиденья: стеганые по отсекам, наполнение из натурального пуха с вставками из полиуретана плотностью 30 кг/м<sup>3</sup>.\*  
\*Полностью съемные чехлы из ткани, несъемные чехлы из кожи.

Das Gestell besteht aus Massiv- und Schichtholz, mit geflochtenen Gummigurten, gepolstert mit Polyurethanschaumstoff, mit Dacron bezogen. Ruckenkissen aus Piumafib, einer hypoallergischen speziellen Mischung aus echter Daune und silikonisierter Polyesterfaser\*. Die Sitzkissen bestehen aus einem Schaumkern mit Dichte 30 Kg/m<sup>3</sup> mit einer gekammerten Daunenaufgabe\*. Stoffbezüge alle abziehbar, Leder und Kunstleder festbezogen. Als Bettsofa nicht verfügbar. Wartungsanleitungen fuer Daunenkissen: Die Kissen, die Daunen enthalten, neigen dazu, sich durch Gebrauch zu verformen. Um die ursprüngliche Form zu halten, ist es notwendig, auch nach kurzem Gebrauch, die Kissen wiederholt aufzuschütteln. Keinen Ausklopfen oder Staubsauger verwenden. Unseren Kunden, die diese Anweisungen nicht befolgen moechten, oder die kein Sofa mit solchem "gebrauchten" Aussehen haben moechten, empfehlen wir Polyurethan-Kissen.

Вариант со спальным местом не предусмотрен.  
\*Эксплуатация подушек с пуховым наполнением: В процессе эксплуатации подушки с пуховым наполнением могут деформироваться, во избежание чего их необходимо слегка взбивать вручную даже после непродолжительного нахождения на диване. Использование в этих целях пылесоса или выбивалки для одежды категорически запрещено. Если клиент не планирует следовать данным инструкциям и хочет, чтобы подушки сиденья и спинки проминались по минимуму, посоветуйте выбрать наполнение только из полиуретана, полностью исключив натуральный пух.

# Clipper

DESIGN  
STEFANO GALLIZOLI  
2019

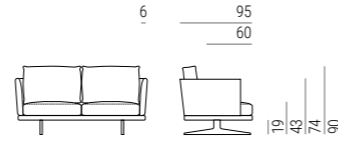

# Clipper

DESIGN  
STEFANO GALLIZOLI  
2019

Divani  
Sofas

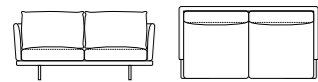

**9CLP201**  
L184 P95 H90

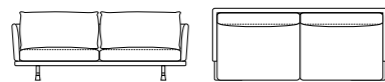

**9CLP202**  
L224 P95 H90

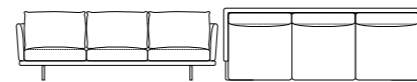

**9CLP203**  
L264 P95 H90

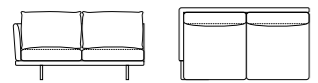

**9CLP204**  
L172 P95 H90

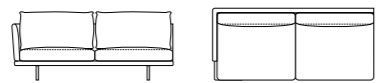

**9CLP205**  
L212 P95 H90

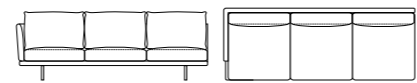

**9CLP206**  
L252 P95 H90



**9CLP207**  
L212 P95 H90

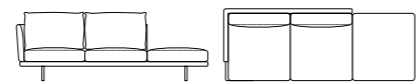

**9CLP208**  
L252 P95 H90

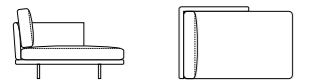

**9CLP209**  
L144 P95 H90

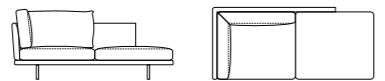

**9CLP212**  
L212 P95 H90

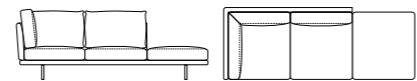

**9CLP213**  
L252 P95 H90

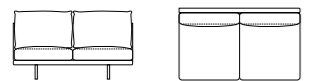

**9CLP214**  
L160 P95 H90

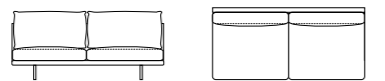

**9CLP215**  
L200 P95 H90

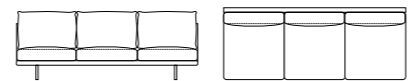

**9CLP216**  
L240 P95 H90

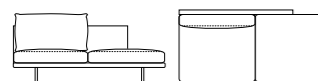

**9CLP217**  
L200 P95 H90

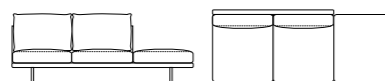

**9CLP218**  
L240 P95 H90



**9CLP219**  
L264 P95 H90

## Accessori Accessories

Cuscinetto in piuma  
senza fascia  
Feather cushion  
without band



**9CU103**  
L40 H40

Cuscino in piuma  
senza fascia  
Feather back cushion  
without band



**9CU106**  
L45 P45

Cuscinetto in piuma  
senza fascia  
Feather cushion  
without band



**9CUT103**  
L40 H40

Cuscino in piuma  
senza fascia  
Feather back cushion  
without band



**9CUT106**  
L45 P45

## Piedini Feet

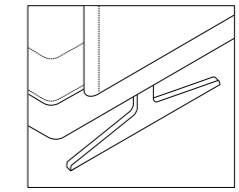

**Versione A** (standard)  
in metallo  
**Version A** (standard)  
in metal

H 19 cm

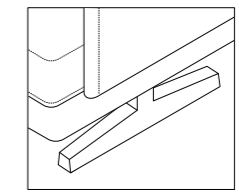

**Versione B** (optional)  
in rovere  
**Version B** (optional)  
in oak

H 19 cm

## Finiture Finishes

Base legno  
Wooden base

Code

Code

Code

Code



Cherry stained oak **OPR1** | Wengé stained oak **OPR2** | Walnut stained oak **OPR3** | Natural oak **OPR4** | Black stained oak **OPR5** | Cherry Milano stained oak **OPR6**



Tobacco stained oak **OPR8** | Grey taupe stained oak **OPR9** | Whitened oak **OPR10** | Charcoal stained oak **OPR11** | Mahogany stained oak **OPR12** | Moka matt stained oak **OPR15**



Shiny chrome metal **OPM1** | Brushed matt chrome metal **OPM2** | Brushed matt dark grey metal **OPM3** | RAL 9017 black painted metal **OPM6** | RAL 9016 white painted metal **OPM7** | Classic bronze painted metal **OPM9**



Golden beach painted metal **OPM10** | Gold pearl painted metal **OPM11** | Brushed copper metal **OPM12** | Brushed antique brass metal **OPM13** | Brushed antique gold metal **OPM15** | Anodyc Bronze painted metal **OPM18**

# Clipper Low

DESIGN  
STEFANO GALLIZOLI  
2019

364

LIFESTYLE COLLECTION 2021 \_ MARELLI

Fusto in legno massello e legno multistrato con cinghie elastiche intrecciate. Imbottitura in poliuretano espanso rivestito in vellutino bianco. Cuscini di schienale in Piumafib, una speciale miscela ipoallergenica di vera piuma e fibra poliestere siliconata\*. Cuscini di seduta costituiti da un inserto in poliuretano con densità di 30 Kg/m<sup>3</sup> ricoperto da un trapuntino di vera piuma imbottito a scomparti\*. Completamente sfoderabile in tessuto, non sfoderabile in pelle e finta pelle.

Kit letto non disponibile.

\*Manutenzione dei cuscini contenenti piuma:

I cuscini contenenti piuma tendono a deformarsi con l'utilizzo. Per mantenerne la forma è necessario, anche dopo un breve utilizzo, battere e sprimacciare ripetutamente i cuscini. Non utilizzare mai battipanni o aspirapolvere. A coloro che non desiderassero seguire queste indicazioni o che volessero un divano dall'aspetto meno vissuto, raccomandiamo di preferire dei cuscini in gomma.

*Carcasse en bois massif et multiplis muni de bandes élastiques entrecroisées et finie de mousse polyuréthane couverte de dacron. Coussins de dossier en Piumafib, un mélange hypoallergénique spécial de véritable duvet et fibre polyester siliconisée\*. Les coussins d'assise sont composés d'un noyau en mousse polyuréthane d'une densité de 30 kg/m<sup>3</sup> couvert de véritable duvet broché en compartiments\*. Revêtement complètement déhoussable en tissu, fixe en cuir et cuir look. Pas disponible en canapé-lit.*

\*Entretien de coussins en duvet:

*Coussins en duvet ont tendance à perdre leur forme dû à l'usage. Pour en conserver la forme il est nécessaire, aussi après un usage court, de régulièrement battre les coussins. Ne jamais utiliser la tapette ou l'aspirateur. A ceux qui ne désirent pas suivre ces indications ou qui souhaitent un canapé qui ait l'air moins "usé", nous conseillons vivement de choisir des coussins en mousse polyuréthane.*

*Frame made of solid wood and multi-ply wood with interwoven elastic straps. The upholstery is made of polyurethane foam, covered with dacron. The back cushions are filled with Piumafib, a special hypoallergenic mixture of feathers and siliconised polyfibre\*. The seat cushions are made of a foam insert with density of 30 Kg/m<sup>3</sup>, covered with a feather compartments quilt\*. Fully removable fabric covers, fixed leather and artificial leather covers. Sofa-bed is not available.*

\*Maintenance of feather cushions:

*Cushions filled with feathers tend to change their shape with use. In order to keep their shape it is necessary, even after a short use, to plump up the cushions repeatedly. Never use carpet beater or vacuum cleaner. We recommend to choose foam cushions to those who do not wish to follow these instructions or to have a "used look" sofa.*

*Для производства каркаса используется массив дерева и многослойная фанера в сочетании с перекрещивающимися эластичными ремнями. Наполнение из полиуретана, обернутого в белый бархат. Наполнение подушек спинки выполнено из материала Piumafib – специальной, не вызывающей аллергию смеси из натурального пуха и полиэфирных силиконовых волокон\*. Подушки сиденья: стеганые по отсекам, наполнение из натурального пуха с вставками из полиуретана плотностью 30 кг/м<sup>3</sup> \*. Полностью съемные чехлы из ткани, несъемные чехлы из кожи.*

*Das Gestell besteht aus Massiv- und Schichtholz, mit geflochtenen Gummigurten, gepolstert mit Polyurethanschaumstoff, mit Dacron bezogen. Rueckenkissen aus Piumafib, einer hypoallergischen speziellen Mischung aus echter Daune und silikonisierter Polyesterfaser\*. Die Sitzkissen bestehen aus einem Schaumkern mit Dichte 30 Kg/m<sup>3</sup> mit einer gekammerten Daunenauflage\*. Stoffbezüge alle abziehbar, Leder und Kunstleder festbezogen. Als Bettsofa nicht verfügbar. Wartungsanleitungen fuer Daunenkissen:*

*Die Kissen, die Daunen enthalten, neigen dazu, sich durch Gebrauch zu verformen. Um die ursprüngliche Form zu halten, ist es notwendig, auch nach kurzem Gebrauch, die Kissen wiederholt aufzuschütteln. Keinen Ausklopfer oder Staubsauger verwenden. Unseren Kunden, die diese Anweisungen nicht befolgen moechten, oder die kein Sofa mit solchem "gebrauchten" Aussehen haben moechten, empfehlen wir Polyurethan-Kissen.*

*Вариант со спальным местом не предусмотрен. \*Эксплуатация подушек с пуховым наполнением: В процессе эксплуатации подушки с пуховым наполнением могут деформироваться, во избежание чего их необходимо слегка взбивать вручную даже после непродолжительного нахождения на диване. Использование в этих целях пылесоса или выбивалки для одежды категорически запрещено. Если клиент не планирует следовать данным инструкциям и хочет, чтобы подушки сиденья и спинки проминались по минимуму, посоветуйте выбрать наполнение только из полиуретана, полностью исключив натуральный пух.*



# Clipper Low

DESIGN  
STEFANO GALLIZOLI  
2019

365

LIFESTYLE COLLECTION 2021 \_ MARELLI

Divani  
Sofas

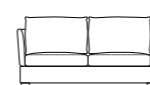

**9CLL201**  
L184 P95 H90



**9CLL202**  
L224 P95 H90

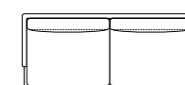

**9CLL203**  
L264 P95 H90

Finiture  
Finishes

Piedini in metallo  
Metal feet

Code

Code



Brushed matt chrome metal  
**OPM2**



Brushed matt dark grey metal  
**OPM3**



RAL 9017 traffic black painted metal  
**OPM6**

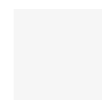

RAL 9016 white painted metal  
**OPM7**



Classic bronze painted metal  
**OPM9**



Golden beach painted metal  
**OPM10**



Gold pearl painted metal  
**OPM11**



Brushed copper metal  
**OPM12**



Brushed antique brass metal  
**OPM13**



Brushed antique gold metal  
**OPM15**

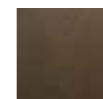

Anodized bronze metal  
**OPM18**



# Clipper Chair

DESIGN  
STEFANO GALLIZOLI  
2021

366

LIFESTYLE COLLECTION 2021 \_ MARELLI

Schienale in legno multistrato di pioppo curvato imbottito con poliuretano espanso con densità 30 kg/m<sup>3</sup>. Seduta in legno multistrato di pioppo imbottito con poliuretano espanso con densità 40 kg/m<sup>3</sup>, rivestito in dacron con cinghie elastiche intrecciate. Rivestimento fisso.

*Dossier en bois multiplis de peuplier courbé fini de mousse de polyuréthane de densité de 30 kg/m<sup>3</sup>. Structure d'assise en bois multiplis de peuplier finie de mousse de polyuréthane de densité de 40 kg/m<sup>3</sup> couverte de dacron, muni de bandes élastiques entrecroisées. Le revêtement est toujours fixe.*

Backrest made of curved multi-ply poplar wood, upholstered with polyurethane foam with density 30 kg/m<sup>3</sup>. Seat structure made of multi-ply poplar wood, upholstered with polyurethane foam with density 40 kg/m<sup>3</sup>, covered with dacron, with interwoven elastic belts. Fixed covers.

*Спинка: гнутая многослойная фанера из тополя в сочетании со вспененным полиуретаном плотностью 30кг/м<sup>3</sup>. Сиденье: гнутая многослойная фанера из тополя в сочетании со вспененным полиуретаном плотностью 40кг/м<sup>3</sup>, обернутым в дакрон. Подвеска из перекрещивающихся эластичных ремней. Обивка съёмная.*

Rückenlehne aus gebogenem Pappelschichtholz, gepolstert mit Polyurethan-Schaumstoff mit Dichte 30 Kg/m<sup>3</sup>. Sitzstruktur aus Pappelschichtholz, gepolstert mit Polyurethan-Schaumstoff mit Dichte 40 Kg/m<sup>3</sup>, mit Dacron Ummantelt, mit gefrochtenen Gummigurten. Clipper ist immer festbezogen.

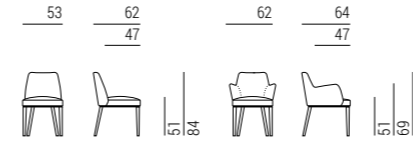

Sedie  
Chairs



**9CLX301**  
Base in legno/Wooden base  
**9CLX302**  
Base in metallo/Metal base  
L53 P62 H84



**9CLX303**  
Base in legno/Wooden base  
**9CLX304**  
Base in metallo/Metal base  
L62 P64 H86

# Clipper Chair

DESIGN  
STEFANO GALLIZOLI  
2021

367

LIFESTYLE COLLECTION 2021 \_ MARELLI

Finiture  
Finishes

Base legno  
Wooden base



Code  
Cherry stained oak **OPR1** | Wengé stained oak **OPR2** | Walnut stained oak **OPR3** | Natural oak **OPR4** | Black stained oak **OPR5** | Cherry Milano stained oak **OPR6**



Code  
Tobacco stained oak **OPR8** | Grey taupe stained oak **OPR9** | Whitened oak **OPR10** | Charcoal stained oak **OPR11** | Mahogany stained oak **OPR12** | Moka matt stained oak **OPR15**

Base metallo  
Metal base

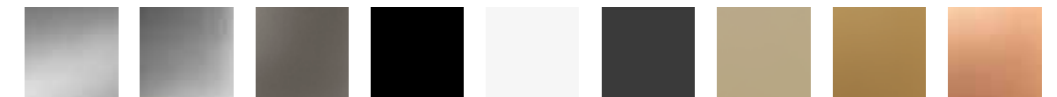

Code  
Shiny chrome metal **OPM1** | Brushed matt chrome metal **OPM2** | Brushed matt dark grey metal **OPM3** | RAL 9017 traffic black painted metal **OPM6** | RAL 9016 white painted metal **OPM7** | Classic bronze painted metal **OPM9** | Golden beach painted metal **OPM10** | Gold pearl painted metal **OPM11** | Brushed copper metal **OPM12**



Code  
Brushed antique brass metal **OPM13** | Shiny black chrome metal **OPM14** | Brushed antique gold metal **OPM15** | Shiny brass chrome metal **OPM16** | Bronze metal **OPM17** | Anodic Bronze painted metal **OPM18**

Tavoli  
Tables



**7DU101**  
Ø40 H42  
con top marmo  
with marble top  
**7DU111**  
Ø40 H42  
con top vetro  
with glass top



**7DU102**  
Ø40 H52  
con top marmo  
with marble top  
**7DU112**  
Ø40 H542  
con top vetro  
with glass top

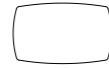

**7DU103**  
L130 P80 H37  
con top marmo  
with marble top  
**7DU113**  
L130 P80 H37  
con top vetro  
with glass top



**7DU104**  
L120 P80 H37  
con top marmo  
with marble top  
**7DU114**  
L120 P80 H37  
con top vetro  
with glass top



**7DU105**  
L90 P90 H37  
con top marmo  
with marble top  
**7DU115**  
L90 P90 H37  
con top vetro  
with glass top

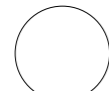

**7DU106**  
Ø125 H37  
con top marmo  
with marble top  
**7DU116**  
Ø125 H37  
con top vetro  
with glass top



**7DU107**  
L100 P100 H37  
con top marmo  
with marble top  
**7DU117**  
L100 P100 H37  
con top vetro  
with glass top



**7DU108**  
Ø80 H37  
con top marmo  
with marble top  
**7DU118**  
Ø80 H37  
con top vetro  
with glass top

Finiture  
Finishes

Top/base in legno  
Wooden base/top



**Code**  
Cherry stained oak **OPR1** Wengé stained oak **OPR2** Walnut stained oak **OPR3** Natural oak **OPR4** Black stained oak **OPR5** Cherry Milano stained oak **OPR6**



**Code**  
Tobacco stained oak **OPR8** Grey taupe stained oak **OPR9** Whitened oak **OPR10** Charcoal stained oak **OPR11** Mahogany stained oak **OPR12** Moka matt stained oak **OPR15**

Top in marmo  
Marble top



**Code**  
White Carrara marble **OPP1** Black Marquina marble **OPP2** Brown Emperador marble **OPP3** Grey Serena stone **OPP4** Beige Brera stone **OPP5** Calacatta gold marble **OPP7** Black and gold marble **OPP9** Perfetto brown marble **OPP10** Grey Stone marble **OPP11** Guatemala green marble **OPP12**

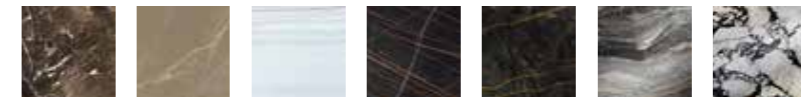

**Code**  
Velvet brown marble **OPP13** Amani Bronze marble **OPP14** Covelano white marble **OPP15** Sahara noir marble **OPP16** Port Laurent marble **OPP17** Arabescato orobico grey marble **OPP20** Calacatta violet marble **OPP21**

Top in Gres Porcellanato  
Porcelain Stoneware Top



**Code**  
Nero Marquina **OPG2** Statuario Select **OPG3** Calacatta Royal **OPG4** Bianco Dolomite **OPG5**

Top in vetro  
Glass top



**Code**  
Transparent glass **OPV1** Frosted glass **OPV2** RAL 9016 traffic white back-painted glass **OPV3** RAL 9017 traffic black back-painted glass **OPV4** RAL 7044 silk grey back-painted glass **OPV5** RAL 1019 grey beige back-painted glass **OPV6** Chrome back-painted bronze glass **OPV9** Chrome back-painted grey glass **OPV10** Transparent bronze glass **OPV12** Transparent grey glass **OPV13**

## Tavoli Tables

Tavolini con piano rotondo  
Coffee tables with round top

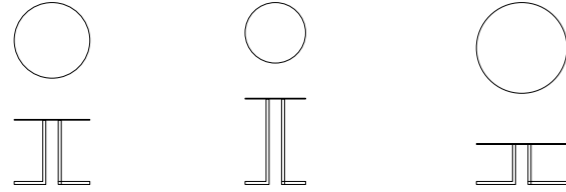

**7EL101**  
Tavolino in metallo  
Metal coffee table  
**7EL201**  
Top marmo/Marble top  
Ø50 H43

**7EL103**  
Tavolino in metallo  
Metal coffee table  
**7EL202**  
Top marmo/Marble top  
Ø40 H57

**7EL105**  
Tavolino in metallo  
Metal coffee table  
**7EL203**  
Top marmo/Marble top  
Ø60 H27

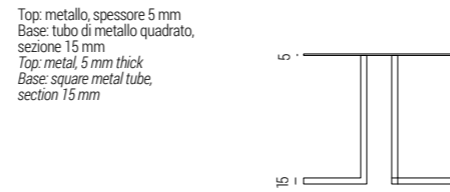

Top: metallo, spessore 5 mm  
Base: tubo di metallo quadrato,  
sezione 15 mm  
Top: metal, 5 mm thick  
Base: square metal tube,  
section 15 mm

Tavolini con piano quadrato  
e angoli arrotondati  
Coffee tables with square top  
with rounded edges

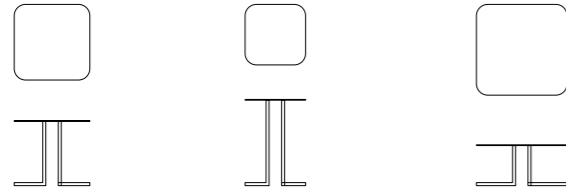

**7EL107**  
Tavolino in metallo  
Metal coffee table  
**7EL204**  
Top marmo/Marble top  
L50 P50 H43

**7EL108**  
Tavolino in metallo  
Metal coffee table  
**7EL205**  
Top marmo/Marble top  
L40 P40 H57

**7EL109**  
Tavolino in metallo  
Metal coffee table  
**7EL206**  
Top marmo/Marble top  
L60 P60 H27

Tavolini con piano quadrato  
Coffee tables with square top

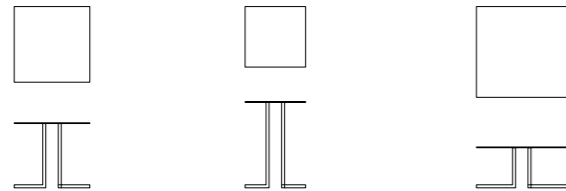

**7EL110**  
Tavolino in metallo  
Metal coffee table  
**7EL207**  
Top marmo/Marble top  
L50 P50 H43

**7EL111**  
Tavolino in metallo  
Metal coffee table  
**7EL208**  
Top marmo/Marble top  
L40 P40 H57

**7EL112**  
Tavolino in metallo  
Metal coffee table  
**7EL209**  
Top marmo/Marble top  
L60 P60 H27

## Finiture Finishes

Metallo verniciato  
Painted metal



**Code**  
RAL 9017 black painted metal **OPM6**  
RAL 9016 white painted metal **OPM7**  
Metal painted in RAL Classic colors **OPM8**  
Classic bronze painted metal **OPM9**  
Golden beach painted metal **OPM10**  
Gold pearl painted metal **OPM11**  
Anodized Bronze metal **OPM18**

Metallo cromato o spazzolato  
Chrome or brushed metal



**Code**  
Shiny chrome metal **OPM1**  
Brushed matt chrome metal **OPM2**  
Brushed matt dark grey metal **OPM3**  
Brushed copper metal **OPM12**  
Brushed antique brass metal **OPM13**  
Shiny black chrome metal **OPM14**  
Brushed antique gold metal **OPM15**  
Shiny brass chrome metal **OPM16**  
Bronze metal **OPM17**

Top in marmo  
Marble top

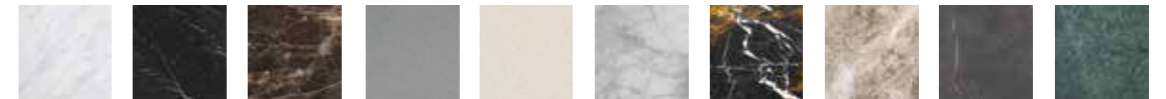

**Code**  
White Carrara marble **OPP1**  
Black Marquina marble **OPP2**  
Brown Emperador marble **OPP3**  
Grey Serena stone **OPP4**  
Beige Brera stone **OPP5**  
Calacatta gold marble **OPP7**  
Black and gold marble **OPP9**  
Perfetto brown marble **OPP10**  
Grey Stone marble **OPP11**  
Guatemala green marble **OPP12**

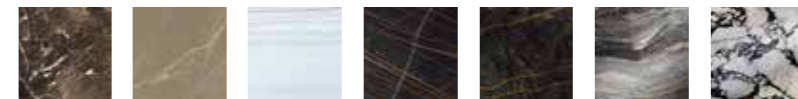

**Code**  
Velvet brown marble **OPP13**  
Amani Bronze marble **OPP14**  
Covelano white marble **OPP15**  
Sahara noir marble **OPP16**  
Port Laurent marble **OPP17**  
Arabescato orobico grey marble **OPP20**  
Calacatta violet marble **OPP21**

Top in Gres Porcellanato  
Porcelain Stoneware Top



**Code**  
Nero Marquina **OPG2**  
Statuario Select **OPG3**  
Calacatta Royal **OPG4**  
Bianco Dolomite **OPG5**

# Frame

DESIGN  
STUDIO MARELLI  
2009

372

LIFESTYLE COLLECTION 2021 \_ MARELLI

## Tavoli Tables



**7FR101**  
Top in vetro/Glass top  
**7FR111**  
Top in legno/Wooden top  
**7FR123**  
Top in marmo/Marble top  
L70 P70 H28

**7FR102**  
Top in vetro/Glass top  
**7FR112**  
Top in legno/Wooden top  
**7FR124**  
Top in marmo/Marble top  
L120 P70 H28

**7FR103**  
Top in vetro/Glass top  
**7FR113**  
Top in legno/Wooden top  
**7FR125**  
Top in marmo/Marble top  
L100 P100 H28

**7FR131**  
Top in vetro/Glass top  
**7FR136**  
Top in legno/Wooden top  
**7FR139**  
Top in marmo/Marble top  
L70 P70 H40

**7FR132**  
Top in vetro/Glass top  
**7FR137**  
Top in legno/Wooden top  
**7FR140**  
Top in marmo/Marble top  
L120 P70 H40

**7FR133**  
Top in vetro/Glass top  
**7FR138**  
Top in legno/Wooden top  
**7FR141**  
Top in marmo/Marble top  
L100 P100 H40

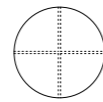
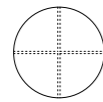

**7FR104**  
Top in vetro/Glass top  
**7FR147**  
Top in legno/Wooden top  
**7FR121**  
Top in marmo/Marble top  
Ø100 H28

**7FR105**  
Top in vetro/Glass top  
**7FR148**  
Top in legno/Wooden top  
**7FR122**  
Top in marmo/Marble top  
Ø120 H28

**7FR134**  
Top in vetro/Glass top  
**7FR149**  
Top in legno/Wooden top  
**7FR142**  
Top in marmo/Marble top  
Ø100 H40

**7FR135**  
Top in vetro/Glass top  
**7FR150**  
Top in legno/Wooden top  
**7FR143**  
Top in marmo/Marble top  
Ø120 H40

**7FR151**  
Top in vetro/Glass top  
**7FR152**  
Top in legno/Wooden top  
**7FR153**  
Top in marmo/Marble top  
L50 P50 H50

**7FR106**  
Top in vetro/Glass top  
**7FR116**  
Top in legno/Wooden top  
**7FR126**  
Top in marmo/Marble top  
L35 P35 H52



**7FR162**  
Top in legno/Wooden top  
**7FR163**  
Top in marmo/Marble top  
**7FR164**  
Top in vetro/Glass top  
Ø40 H40

**7FR165**  
Top in legno/Wooden top  
**7FR166**  
Top in marmo/Marble top  
**7FR167**  
Top in vetro/Glass top  
Ø40 H50

**7FR168**  
Top in legno/Wooden top  
**7FR169**  
Top in marmo/Marble top  
**7FR170**  
Top in vetro/Glass top  
Ø60 H40

**7FR171**  
Top in legno/Wooden top  
**7FR172**  
Top in marmo/Marble top  
**7FR173**  
Top in vetro/Glass top  
Ø60 H40

# Frame

DESIGN  
STUDIO MARELLI  
2009

373

LIFESTYLE COLLECTION 2021 \_ MARELLI

## Tavoli Tables

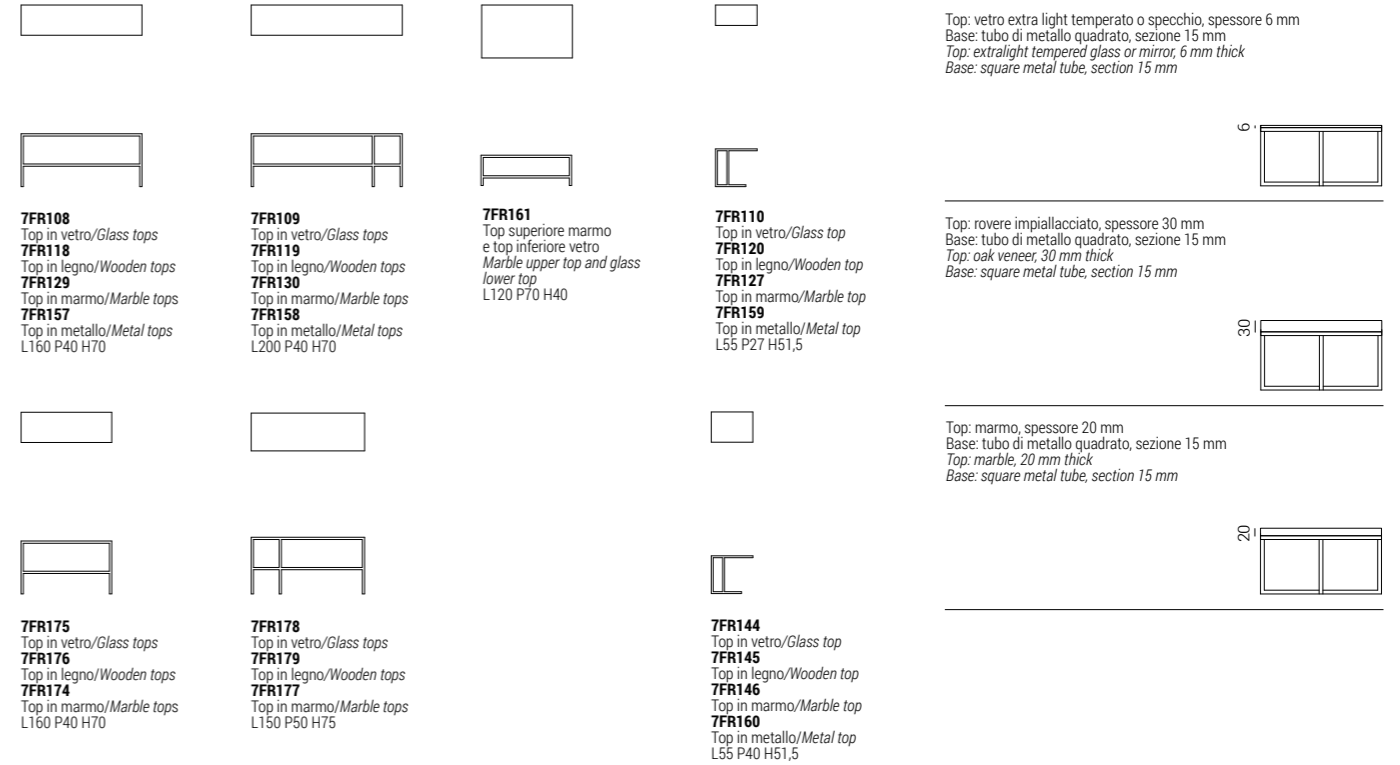

**7FR108**  
Top in vetro/Glass tops  
**7FR118**  
Top in legno/Wooden tops  
**7FR129**  
Top in marmo/Marble tops  
**7FR157**  
Top in metallo/Metal tops  
L160 P40 H70

**7FR109**  
Top in vetro/Glass tops  
**7FR119**  
Top in legno/Wooden tops  
**7FR130**  
Top in marmo/Marble tops  
**7FR158**  
Top in metallo/Metal tops  
L200 P40 H70

**7FR161**  
Top superiore marmo  
e top inferiore vetro  
Marble upper top and glass  
lower top  
L120 P70 H40

**7FR110**  
Top in vetro/Glass top  
**7FR120**  
Top in legno/Wooden top  
**7FR127**  
Top in marmo/Marble top  
**7FR159**  
Top in metallo/Metal top  
L55 P27 H51,5

Top: vetro extra light temperato o specchio, spessore 6 mm  
Base: tubo di metallo quadrato, sezione 15 mm  
Top: extralight tempered glass or mirror, 6 mm thick  
Base: square metal tube, section 15 mm

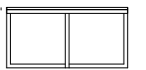

Top: rovere impiallacciato, spessore 30 mm  
Base: tubo di metallo quadrato, sezione 15 mm  
Top: oak veneer, 30 mm thick  
Base: square metal tube, section 15 mm



Top: marmo, spessore 20 mm  
Base: tubo di metallo quadrato, sezione 15 mm  
Top: marble, 20 mm thick  
Base: square metal tube, section 15 mm



**7FR175**  
Top in vetro/Glass tops  
**7FR176**  
Top in legno/Wooden tops  
**7FR174**  
Top in marmo/Marble tops  
L160 P40 H70

**7FR178**  
Top in vetro/Glass tops  
**7FR179**  
Top in legno/Wooden tops  
**7FR177**  
Top in marmo/Marble tops  
L150 P50 H75

**7FR144**  
Top in vetro/Glass top  
**7FR145**  
Top in legno/Wooden top  
**7FR146**  
Top in marmo/Marble top  
**7FR160**  
Top in metallo/Metal top  
L55 P40 H51,5

# Frame

DESIGN  
STUDIO MARELLI  
2009

374

LIFESTYLE COLLECTION 2021 \_ MARELLI

## Finiture Finishes

Top in vetro Glass top										
Code	Transparent glass <b>OPV1</b>	Frosted glass <b>OPV2</b>	RAL 9016 traffic white back-painted glass <b>OPV3</b>	RAL 9017 traffic black back-painted glass <b>OPV4</b>	RAL 7044 silk grey back-painted glass <b>OPV5</b>	RAL 1019 grey beige back-painted glass <b>OPV6</b>	Chrome back-painted bronze glass <b>OPV9</b>	Chrome back-painted grey glass <b>OPV10</b>	Transparent bronze glass <b>OPV12</b>	Transparent grey glass <b>OPV13</b>
Top in legno Wooden top										
Code	Cherry stained oak <b>OPR1</b>	Wengé stained oak <b>OPR2</b>	Walnut stained oak <b>OPR3</b>	Natural oak <b>OPR4</b>	Black stained oak <b>OPR5</b>	Cherry Milano stained oak <b>OPR6</b>	Tobacco stained oak <b>OPR8</b>			
Code	Grey taupe stained oak <b>OPR9</b>	Whitened oak <b>OPR10</b>	Charcoal stained oak <b>OPR11</b>	Mahogany stained oak <b>OPR12</b>	Moka matt stained oak <b>OPR15</b>					
Top in marmo Marble top										
Code	White Carrara marble <b>OPP1</b>	Black Marquinia marble <b>OPP2</b>	Brown Emperador marble <b>OPP3</b>	Grey Serena stone <b>OPP4</b>	Beige Brera stone <b>OPP5</b>	Calacatta gold marble <b>OPP7</b>	Black and gold marble <b>OPP9</b>	Perfetto brown marble <b>OPP10</b>	Grey Stone marble <b>OPP11</b>	Guatemala green marble <b>OPP12</b>
Code	Velvet brown marble <b>OPP13</b>	Amani Bronze marble <b>OPP14</b>	Covelano white marble <b>OPP15</b>	Sahara noir marble <b>OPP16</b>	Port Laurent marble <b>OPP17</b>	Arabescato orobico grey marble <b>OPP20</b>	Calacatta violet marble <b>OPP21</b>			
Top in Gres Porcellanato Porcelain Stoneware Top										
Code	Nero Marquinia <b>OPG2</b>	Statuario Select <b>OPG3</b>	Calacatta Royal <b>OPG4</b>	Bianco Dolomite <b>OPG5</b>						

# Frame

DESIGN  
STUDIO MARELLI  
2009

375

LIFESTYLE COLLECTION 2021 \_ MARELLI

## Finiture Finishes

Top in metallo Metal top										
Code	Brushed matt dark grey metal <b>OPM3</b>	RAL 9017 black painted metal <b>OPM6</b>	RAL 9016 white painted metal <b>OPM7</b>	Classic bronze painted metal <b>OPM9</b>	Golden beach painted metal <b>OPM10</b>	Gold pearl painted metal <b>OPM11</b>	Brushed copper metal <b>OPM12</b>	Brushed antique brass metal <b>OPM13</b>	Brushed antique gold metal <b>OPM15</b>	Anodized Bronze metal <b>OPM18</b>
Base in metallo Metal base										
Code	Shiny chrome metal <b>OPM1</b>	Brushed matt chrome metal <b>OPM2</b>	Brushed matt dark grey metal <b>OPM3</b>	RAL 9017 black painted metal <b>OPM6</b>	RAL 9016 white painted metal <b>OPM7</b>	Classic bronze painted metal <b>OPM9</b>	Golden beach painted metal <b>OPM10</b>	Gold pearl painted metal <b>OPM11</b>		
Code	Brushed copper metal <b>OPM12</b>	Brushed antique brass metal <b>OPM13</b>	Shiny black chrome metal <b>OPM14</b>	Brushed antique gold metal <b>OPM15</b>	Shiny brass chrome metal <b>OPM16</b>	Bronze metal <b>OPM17</b>	Anodized Bronze metal <b>OPM18</b>			

Fusto in legno massello e legno multistrato con cinghie elastiche intrecciate. Imbottitura in poliuretano espanso rivestito in vellutino bianco. Sedute e schienali costituiti da un cuore in poliuretano espanso a quote differenziate 30 Kg/m<sup>3</sup> e 40 Kg/m<sup>3</sup>, ricoperto da un trapuntino di vera piuma imbottito a scomparti\*. Completamente sfoderabile in tessuto, non sfoderabile in pelle e finta pelle. Kit letto non disponibile.

\*Manutenzione dei cuscini contenenti piuma: I cuscini contenenti piuma tendono a deformarsi con l'utilizzo. Per mantenerne la forma è necessario, anche dopo un breve utilizzo, battere e sprimacciare ripetutamente i cuscini. Non utilizzare mai battipanni o aspirapolvere. A coloro che non desiderassero seguire queste indicazioni o che volessero un divano dall'aspetto meno vissuto, raccomandiamo di preferire dei cuscini in gomma.

*Carcasse en bois massif et multiplis muni de bandes élastiques entrecroisées et finie de mousse polyuréthane couverte de dacron. Assises et dossiers composés d'un noyau en mousse polyuréthane de différentes densités de 30 kg/m<sup>3</sup> et 40 kg/m<sup>3</sup> couvert de véritable duvet matelassé en compartiments\*. Revêtement complètement déhoussable en tissu, fixe en cuir et cuir look. Pas disponible en canapé-lit. \*Entretien de coussins en duvet: Coussins en duvet ont tendance à perdre leur forme dû à l'usage. Pour en conserver la forme il est nécessaire, aussi après un usage court, de régulièrement battre les coussins. Ne jamais utiliser la tapette ou l'aspirateur. À ceux qui ne désirent pas suivre ces indications ou qui souhaitent un canapé qui ait l'air moins "usé", nous conseillons vivement de choisir des coussins en mousse polyuréthane.*

*Frame made of solid wood and multi-ply wood with interwoven elastic belts. The upholstery is made of polyurethane foam, covered with dacron. Seats and backs are made of a polyurethane foam core in different densities of 30 Kg/m<sup>3</sup> and 40 Kg/m<sup>3</sup>, covered with a feather compartments quilt\*. Fully removable fabric covers, fixed leather and artificial leather covers. Sofa-bed is not available. \*Maintenance of feather cushions: Cushions filled with feathers tend to change their shape with use. In order to keep their shape it is necessary, even after a short use, to plump up the cushions repeatedly. Never use carpet beater or vacuum cleaner. We recommend to choose foam cushions to those who do not wish to follow these instructions or to have a "used look" sofa.*

*Каркас из массива дерева в сочетании с многослойной фанерой покрыт слоем вспененного полиуретана плотностью 40 кг/м<sup>3</sup>, обернутого в дакрон, подвеска из перекрещивающихся эластичных ремней. В основе наполнения подушек сиденья и спинки вспененный полиуретан различной степени плотности – 30 и 40 кг/м<sup>3</sup>, покрытый стеганым полотном с наполнением из натурального пуха. Целиком съёмные чехлы в ткани и несъёмные в коже, как натуральной, так и искусственной. Уход за подушками с наполнением из натурального пуха:*

*Das Gestell besteht aus Massiv- und Schichtholz, mit geflochtenen Gummigurten, gepolstert mit Polyurethanschaumstoff, mit Dacron bezogen. Sitze und Rücken bestehen aus einem Schaumkern in verschiedenen Dichten von 30 Kg/m<sup>3</sup> und 40 Kg/m<sup>3</sup> mit einer gekammerten Daunenauflage\*. Stoffbezüge alle abziehbar, Leder und Kunstleder festbezogen. Als Bettsofa nicht verfügbare. \*Wartungsanleitungen fuer Daunenkissen: Die Kissen, die Daunen enthalten, neigen dazu, sich durch Gebrauch zu verformen. Um die ursprüngliche Form zu halten, ist es notwendig, auch nach kurzem Gebrauch, die Kissen wiederholt aufzuschütteln. Keinen Ausklopfer oder Staubsauger verwenden. Unseren Kunden, die diese Anweisungen nicht befolgen moechten, oder die kein Sofa mit solchem "gebrauchten" Aussehen haben moechten, empfehlen wir Polyurethan-Kissen.*

*В процессе эксплуатации подушек с наполнением из натурального пуха естественным их деформация неизбежна. Чтобы сохранить форму подушек, их необходимо регулярно взбивать, при этом ни в коем случае не прибегая к использованию выбивалки для одежды или пылесоса. Заказчикам, которые не будут следовать данной рекомендации либо просто предпочитают диваны с недеформируемыми подушками, фабрика рекомендует заказывать наполнение из полиуретана.*

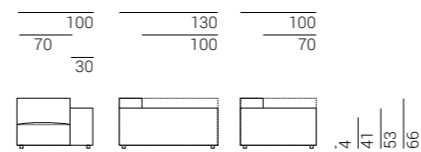

## Elementi componibili Modular elements

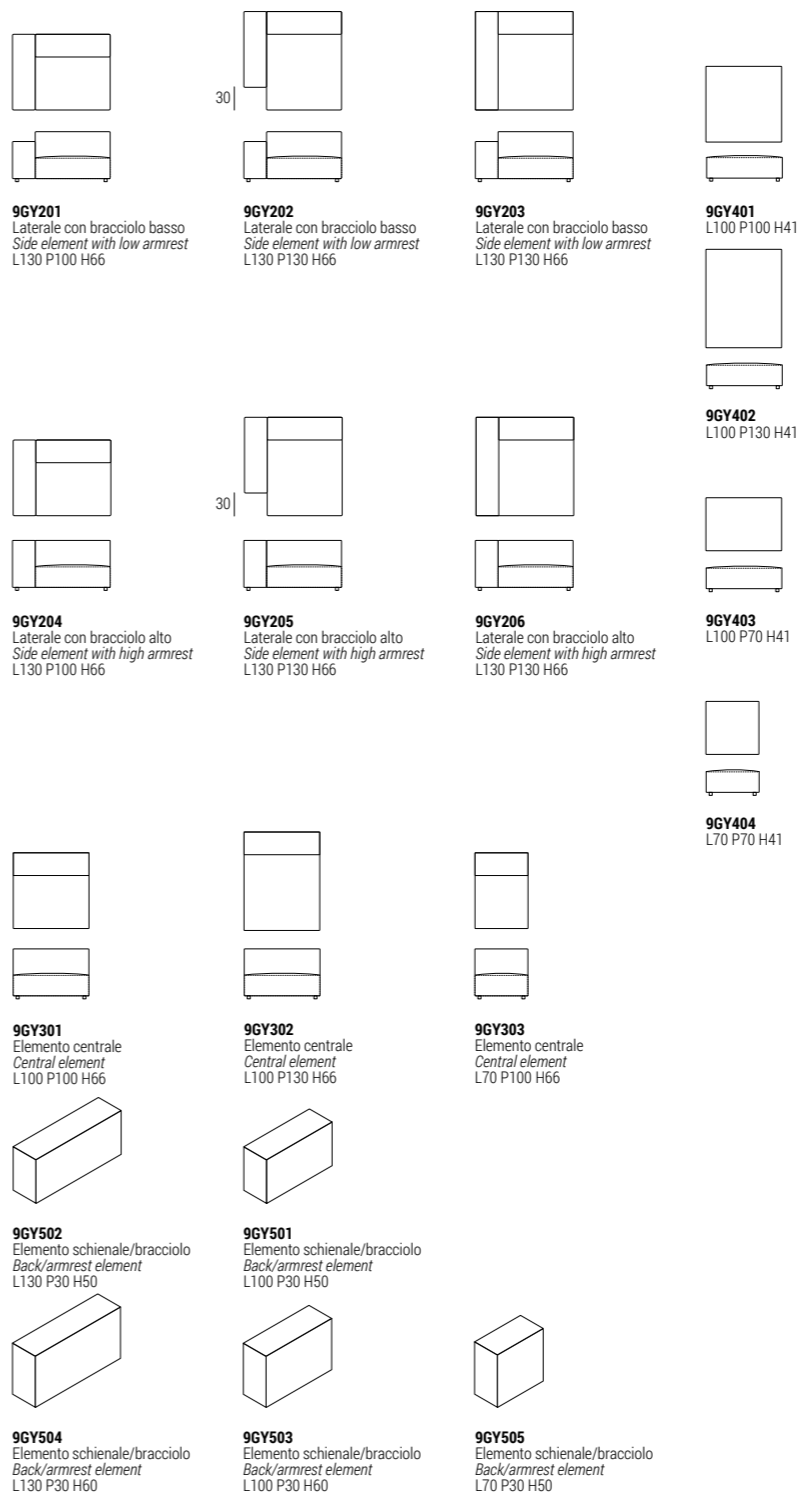

## Accessori Accessories

Cuscino in piuma con profilo  
Feather cushions with piping



**9GY101**  
L40 P40

Cuscino in piuma con profilo  
Feather cushions with piping



**9GY102**  
L45 P45

Cuscino in piuma con profilo  
Feather cushions with piping



**9GY103**  
L60 P60

# Gary Foam

DESIGN  
STUDIO MARELLI  
2021

378

LIFESTYLE COLLECTION 2021 \_ MARELLI

Fusto in legno massello e legno multistrato con cinghie elastiche intrecciate. Imbottitura in poliuretano espanso rivestito in vellutino bianco. Sedute e schienali costituiti da un cuore in poliuretano espanso a quote differenziate 30 Kg/m<sup>3</sup> e 40 Kg/m<sup>3</sup>, ricoperto da un trapuntino di vera piuma imbottito a scomparti\*. Completamente sfoderabile in tessuto, non sfoderabile in pelle e finta pelle. Kit letto non disponibile.

\*Manutenzione dei cuscini contenenti piuma: I cuscini contenenti piuma tendono a deformarsi con l'utilizzo. Per mantenerne la forma è necessario, anche dopo un breve utilizzo, battere e sprimacciare ripetutamente i cuscini. Non utilizzare mai battipanni o aspirapolvere. A coloro che non desiderassero seguire queste indicazioni o che volessero un divano dall'aspetto meno vissuto, raccomandiamo di preferire dei cuscini in gomma.

*Carcasse en bois massif et multiplis muni de bandes élastiques entrecroisées et finie de mousse polyuréthane couverte de dacron. Assises et dossiers composés d'un noyau en mousse polyuréthane de différentes densités de 30 kg/m<sup>3</sup> et 40 kg/m<sup>3</sup> couvert de véritable duvet matelassé en compartiments\*. Revêtement complètement déhoussable en tissu, fixe en cuir et cuir look. Pas disponible en canapé-lit. \*Entretien de coussins en duvet: Coussins en duvet ont tendance à perdre leur forme dû à l'usage. Pour en conserver la forme il est nécessaire, aussi après un usage court, de régulièrement battre les coussins. Ne jamais utiliser la tapette ou l'aspirateur. A ceux qui ne désirent pas suivre ces indications ou qui souhaitent un canapé qui ait l'air moins "usé", nous conseillons vivement de choisir des coussins en mousse polyuréthane.*

*Frame made of solid wood and multi-ply wood with interwoven elastic belts. The upholstery is made of polyurethane foam, covered with dacron. Seats and backs are made of a polyurethane foam core in different densities of 30 Kg/m<sup>3</sup> and 40 Kg/m<sup>3</sup>, covered with a feather compartments quilt\*. Fully removable fabric covers, fixed leather and artificial leather covers. Sofa-bed is not available. \*Maintenance of feather cushions: Cushions filled with feathers tend to change their shape with use. In order to keep their shape it is necessary, even after a short use, to plump up the cushions repeatedly. Never use carpet beater or vacuum cleaner. We recommend to choose foam cushions to those who do not wish to follow these instructions or to have a "used look" sofa.*

*Каркас из массива дерева в сочетании с многослойной фанерой покрыт слоем вспененного полиуретана плотностью 40 кг/м<sup>3</sup>, обернутого в дакрон, подвеска из перекрещивающихся эластичных ремней. В основе наполнения подушек сиденья и спинки вспененный полиуретан различной степени плотности – 30 и 40 кг/м<sup>3</sup>, покрытый стеганым полотном с наполнением из натурального пуха. Целиком съёмные чехлы в ткани и несъёмные в коже, как натуральной, так и искусственной. Уход за подушками с наполнением из натурального пуха:*

*Das Gestell besteht aus Massiv- und Schichtholz, mit geflochtenen Gummigurten, gepolstert mit Polyurethanschaumstoff, mit Dacron bezogen. Sitze und Rücken bestehen aus einem Schaumkern in verschiedenen Dichten von 30 Kg/m<sup>3</sup> und 40 Kg/m<sup>3</sup> mit einer gekammerten Daunenauflage\*. Stoffbezüge alle abziehbar, Leder und Kunstleder festbezogen. Als Bettsofa nicht verfügbare. \*Wartungsanleitungen fuer Daunenkissen: Die Kissen, die Daunen enthalten, neigen dazu, sich durch Gebrauch zu verformen. Um die ursprüngliche Form zu halten, ist es notwendig, auch nach kurzem Gebrauch, die Kissen wiederholt aufzuschütteln. Keinen Ausklopfer oder Staubsauger verwenden. Unseren Kunden, die diese Anweisungen nicht befolgen moechten, oder die kein Sofa mit solchem "gebrauchten" Aussehen haben moechten, empfehlen wir Polyurethan-Kissen.*

*В процессе эксплуатации подушек с наполнением из натурального пуха естественным их деформация неизбежна. Чтобы сохранить форму подушек, их необходимо регулярно взбивать, при этом ни в коем случае не прибегая к использованию выбивалки для одежды или пылесоса. Заказчикам, которые не будут следовать данной рекомендации либо просто предпочитают диваны с недеформируемыми подушками, фабрика рекомендует заказывать наполнение из полиуретана.*

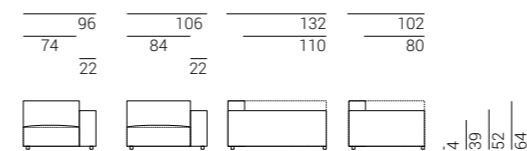

## Elementi componibili Modular elements

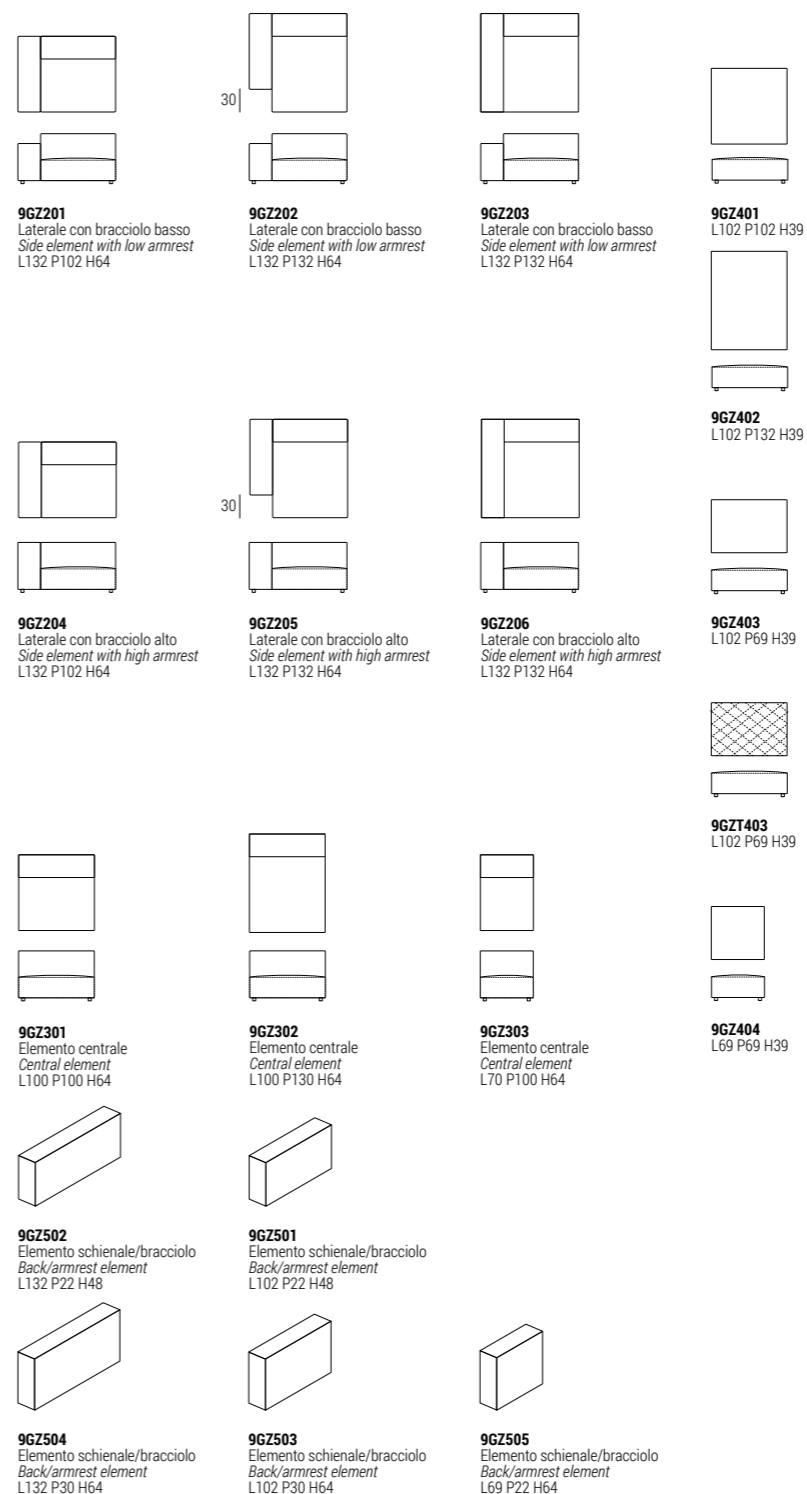

## Accessori Accessories

Cuscino in piuma con profilo  
Feather cushions with piping



**9GY101**  
L40 P40

Cuscino in piuma con profilo  
Feather cushions with piping



**9GY102**  
L45 P45

Cuscino in piuma con profilo  
Feather cushions with piping



**9GY103**  
L60 P60



**9GZT403**  
L102 P69 H39



**9GZ404**  
L69 P69 H39



**9GZ404**  
L69 P69 H39



**9GZ404**  
L69 P69 H39



**9GZ404**  
L69 P69 H39



**9GZ404**  
L69 P69 H39

# Gary Foam

DESIGN  
STUDIO MARELLI  
2021

379

LIFESTYLE COLLECTION 2021 \_ MARELLI

Fusto in legno massello e legno multistrato con cinghie elastiche intrecciate. Imbottitura in poliuretano espanso rivestito in vellutino bianco. Cuscini di schienale in Piumafib, una speciale miscela ipoallergenica di vera piuma e fibra poliestere siliconata\*.

Cuscini di seduta costituiti da un inserto in poliuretano con densità di 30 Kg/m<sup>3</sup> ricoperto da un trapuntino di vera piuma imbottito a scomparti\*. Completamente sfoderabile in tessuto, non sfoderabile in pelle e finta pelle. Kit letto disponibile.

Disponibile anche nella versione con cuscini di seduta e schienale trapuntati  
\* Manutenzione dei cuscini contenenti piuma: I cuscini contenenti piuma tendono a deformarsi con l'utilizzo.

Per mantenerne la forma è necessario, anche dopo un breve utilizzo, battere e sprimacciare ripetutamente i cuscini. Non utilizzare mai battipanni o aspirapolvere. A coloro che non desiderassero seguire queste indicazioni o che volessero un divano dall'aspetto meno vissuto, raccomandiamo di preferire dei cuscini in gomma.

*Carcasse en bois massif et multiplis muni de bandes élastiques entrecroisées et finie de mousse polyuréthane couverte de dacron. Coussins de dossier en Piumafib, un mélange hypoallergénique spécial de véritable duvet et fibre polyester siliconisée\*.*

*Les coussins d'assise sont composés d'un noyau en mousse polyuréthane d'une densité de 30 kg/m<sup>3</sup> couvert de véritable duvet matelassé en compartiments\*. Revêtement complètement déhoussable en tissu, fixe en cuir et cuir look.*

*Disponibile en canapé-lit.*

*Également disponible avec les coussins d'assise et de dossier matelassés.*

*\* Entretien de coussins en duvet:*

*Coussins en duvet ont tendance à perdre leur forme dû à l'usage.*

*Pour en conserver la forme il est nécessaire, aussi après un usage court, de régulièrement battre les coussins. Ne jamais utiliser la tapette ou l'aspirateur.*

*À ceux qui ne désirent pas suivre ces indications ou qui souhaitent un canapé qui ait l'air moins "usé", nous conseillons vivement de choisir des coussins en mousse polyuréthane.*

*Frame made of solid wood and multi-ply wood with interwoven elastic straps. The upholstery is made of polyurethane foam, covered with dacron. The back cushions are filled with Piumafib, a special hypoallergenic mixture of feathers and siliconised polyfibre\*.*

*The seat cushions are made of a foam insert with density of 30 Kg/m<sup>3</sup>, covered with a feather compartments quilt\*. Fully removable fabric covers, fixed leather and artificial leather covers.*

*Sofa-bed is available.*

*Available also with quilted seat and back cushions.*

*\* Maintenance of feather cushions:*

*Cushions filled with feathers tend to change their shape with use.*

*In order to keep their shape it is necessary, even after a short use, to plump up the cushions repeatedly. Never use carpet beater or vacuum cleaner.*

*We recommend to choose foam cushions to those who do not wish to follow these instructions or to have a "used look" sofa.*

*Для производства каркаса используется массив дерева и многослойная фанера в сочетании с перекрещивающимися эластичными ремнями. Наполнение из полиуретана, обернутого в белый бархат. Наполнение подушек спинки выполнено из материала Piumafib – специальной, не вызывающей аллергии смеси из натурального пуха и полиэфирных силиконовых волокон\*. Подушки сиденья: стеганые по отсекам, наполнение из натурального пуха с вставками из полиуретана плотностью 30 кг/м<sup>3</sup> \*. Полностью съемные чехлы из ткани, несъемные чехлы из кожи.*

*Das Gestell besteht aus Massiv- und Schichtholz, mit geflochtenen Gummigurten, gepolstert mit Polyurethanschaumstoff, mit Dacron bezogen. Rueckenkissen aus Piumafib, einer hypoallergischen speziellen Mischung aus echter Daune und silikonisierter Polyesterfaser\*. Die Sitzkissen bestehen aus einem Schaumkern mit Dichte 30 Kg/m<sup>3</sup> mit einer gekammerten Daunenauflege\*.*

*Stoffbezüge alle abziehbar, Leder und Kunstleder festbezogen.*

*Als Bettsofa verfügbbar.*

*Verfügbbar auch mit abgesteppten Sitz- und Rueckenkissen.*

*\* Wartungsanleitungen fuer Daunenkissen:*

*Die Kissen, die Daunen enthalten, neigen dazu, sich durch Gebrauch zu verformen.*

*Um die urspruengliche Form zu halten, ist es notwendig, auch nach kurzem Gebrauch, die Kissen wiederholt aufzuschuettern.*

*Keinen Ausklopfen oder Staubsauger verwenden.*

*Unseren Kunden, die diese Anweisungen nicht befolgen moechten, oder die kein Sofa mit solchem "gebrauchten" Aussehen haben moechten, empfehlen wir Polyurethan-Kissen.*

*Исполнение дивана в версии со спальным местом: возможно Также возможно изготовление подушек сиденья и спинки с декоративной прострочкой  
\* Эксплуатация подушек с пуховым наполнением: В процессе эксплуатации подушки с пуховым наполнением могут деформироваться, во избежание чего их необходимо слегка взбивать вручную даже после непродолжительного нахождения на диване. Использование в этих целях пылесоса или выбивалки для одежды категорически запрещено. Если клиент не планирует следовать данным инструкциям и хочет, чтобы подушки сиденья и спинки проминались по минимуму, посоветуйте выбрать наполнение только из полиуретана, полностью исключив натуральный пух.*

Finiture  
Finishes

Piedini in metallo  
Versione A  
Metal feet  
version A



Code  
Shiny chrome metal OPM1  
Brushed matt chrome metal OPM2  
Brushed matt dark grey metal OPM3  
RAL 9017 traffic black painted metal OPM6  
Classic bronze painted metal OPM9  
Brushed copper metal OPM12



Code  
Brushed antique brass metal OPM13  
Shiny black chrome metal OPM14  
Brushed antique gold metal OPM15  
Shiny brass chrome metal OPM16  
Bronze metal OPM17  
Anodized bronze metal OPM18

Piedini in legno  
Versione B  
Wooden feet  
version B



Code  
Cherry stained beech OPF1  
Wengé stained beech OPF2  
Walnut stained beech OPF3  
Natural beech OPF4  
Black stained beech OPF5  
Cherry Milano stained beech OPF6  
Tobacco stained beech OPF8  
Grey taupe stained beech OPF9  
Charcoal stained beech OPF11  
Mahogany stained beech OPF12



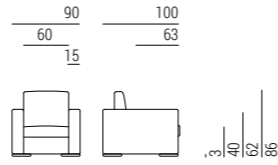

Divani  
Sofas

Elementi componibili  
Modular elements















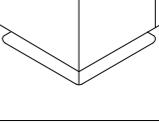
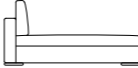

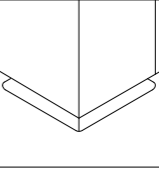
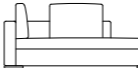

Divani letto  
Sofa-beds

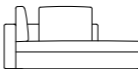
 <b>9G0101</b> L90 P100 H86	 <b>9G0301</b> L115 P100 H86	Elemento angolare Corner element  <b>9G0207</b> L100 P100 H86	 <b>9G0213</b> L190 P100 H86	 Materasso Mattress L115 P190 H15
 <b>9G0202</b> L170 P100 H86	 <b>9G0302</b> L135 P100 H86	Elemento angolare Corner element  <b>9G0208</b> L125 P100 H86	 <b>9G0214</b> L210 P100 H86	 Materasso Mattress L145 P190 H15
 <b>9G0203</b> L190 P100 H86	 <b>9G0303</b> L155 P100 H86	 <b>9G0402</b> L140 P100 H86	 <b>9G0215</b> L230 P100 H86	 Materasso Mattress L160 P190 H15
 <b>9G0204</b> L210 P100 H86	 <b>9G0304</b> L175 P100 H86	 <b>9G0403</b> L160 P100 H86	 <b>9G0216</b> L250 P100 H86	 Materasso Mattress L160 P190 H15
 <b>9G0205</b> L230 P100 H86	 <b>9G0305</b> L195 P100 H86	 <b>9G0404</b> L180 P100 H86	 <b>9G0314</b> L175 P100 H86	 Materasso Mattress L115 P190 H15
 <b>9G0206</b> L250 P100 H86	 <b>9G0306</b> L215 P100 H86	 <b>9G0405</b> L200 P100 H86	 <b>9G0315</b> L195 P100 H86	 Materasso Mattress L145 P190 H15
			 <b>9G0316</b> L215 P100 H86	 Materasso Mattress L160 P190 H15

Dormeuse  
Longchair

Pouf e accessori  
Pouf and accessories

Piedini  
Feet

 <b>9G0102</b> L180 P98 H86	 80	 <b>9G0110</b> L100 P75 H40	 <b>9G0112</b> L100 P125 H40	 Versione A (standard) in metallo Version A (standard) in metal H 3 cm
 <b>9G0103</b> L180 P98 H86	 80	 <b>9G0111</b> L100 P100 H40		 Versione B in legno Version B in wood H 3 cm
 <b>9G0104</b> L200 P98 H86	 55	 <b>9CU103</b> L40 H40 Cuscinetto in piuma senza fascia Feather cushion without band	 <b>9CUT104</b> L60 H60 Cuscinetto trapuntato in piuma senza fascia Quilted feather cushion without band	
 <b>9G0105</b> L200 P98 H86	 80	 <b>9CU105</b> L50 H50 Cuscinetto in piuma senza fascia Feather cushion without band	 <b>9G0107</b> L45 H45 Cuscinetto in piuma con fascia Feather cushion with band	
 <b>9G0106</b> L225 P98 H86	 45	 <b>9CU103</b> L40 H40 Cuscinetto trapuntato in piuma senza fascia Quilted feather cushion without band	 <b>9G0109</b> L80 H40 Cuscinetto in piuma con fascia Feather cushion with band	

Divani  
Sofas

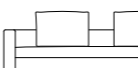
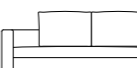
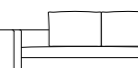
 <b>9G0406</b> L245 P105 H86	 <b>9G0407</b> L187 P105 H86	 <b>9G0408</b> L213 P150 H86
---	---	---

# Gordon Round

# Gordon Move

DESIGN  
STUDIO MARELLI  
2014

Movimento schienali  
Backrest mechanism

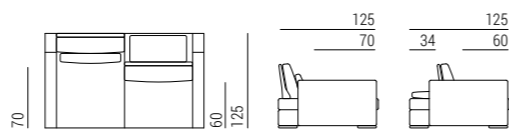

384

LIFESTYLE COLLECTION 2021 \_ MARELLI

Divani  
Sofas

Elementi componibili  
Modular elements

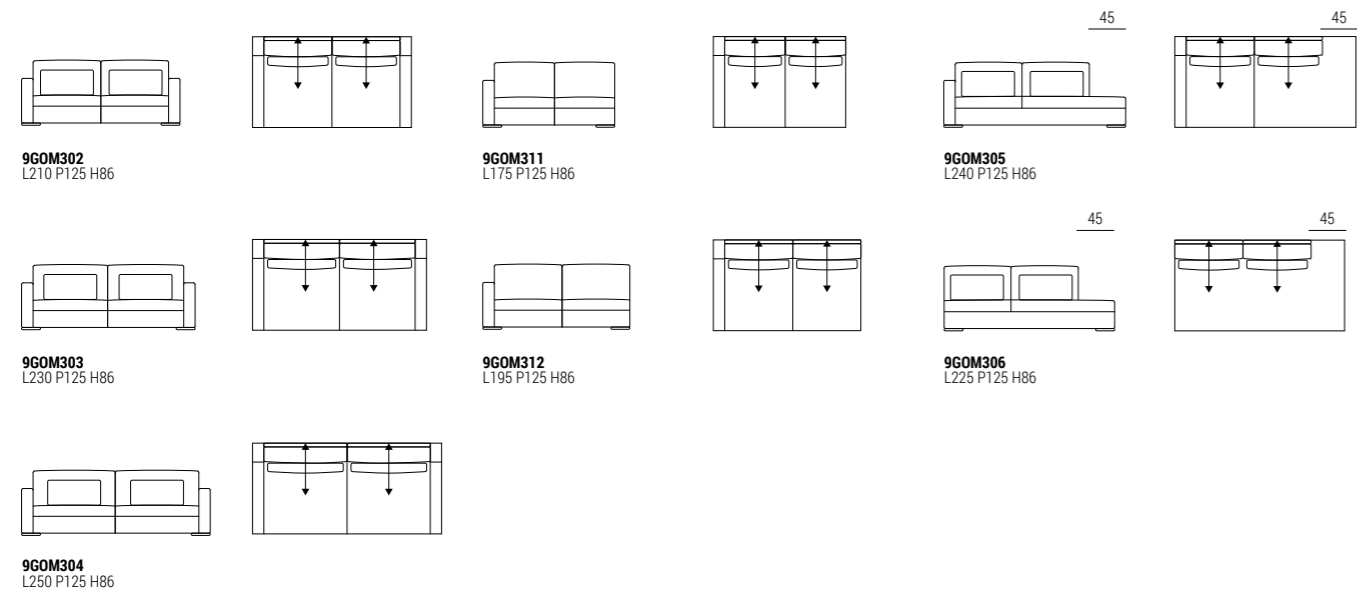

Gli elementi componibili Gordon Move possono essere liberamente combinati con gli elementi Gordon per creare infinite composizioni

The different elements of Gordon Move can be combined with the modular elements of Gordon to create several and different compositions

# Gordon Move

DESIGN  
STUDIO MARELLI  
2014

385

LIFESTYLE COLLECTION 2021 \_ MARELLI

Pouf e accessori  
Pouf and accessories

Piedini  
Feet

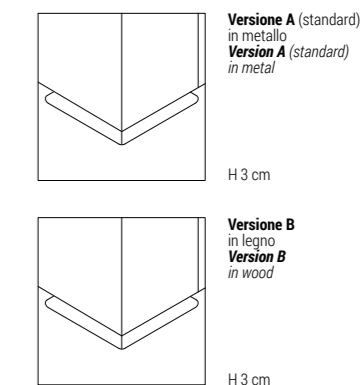
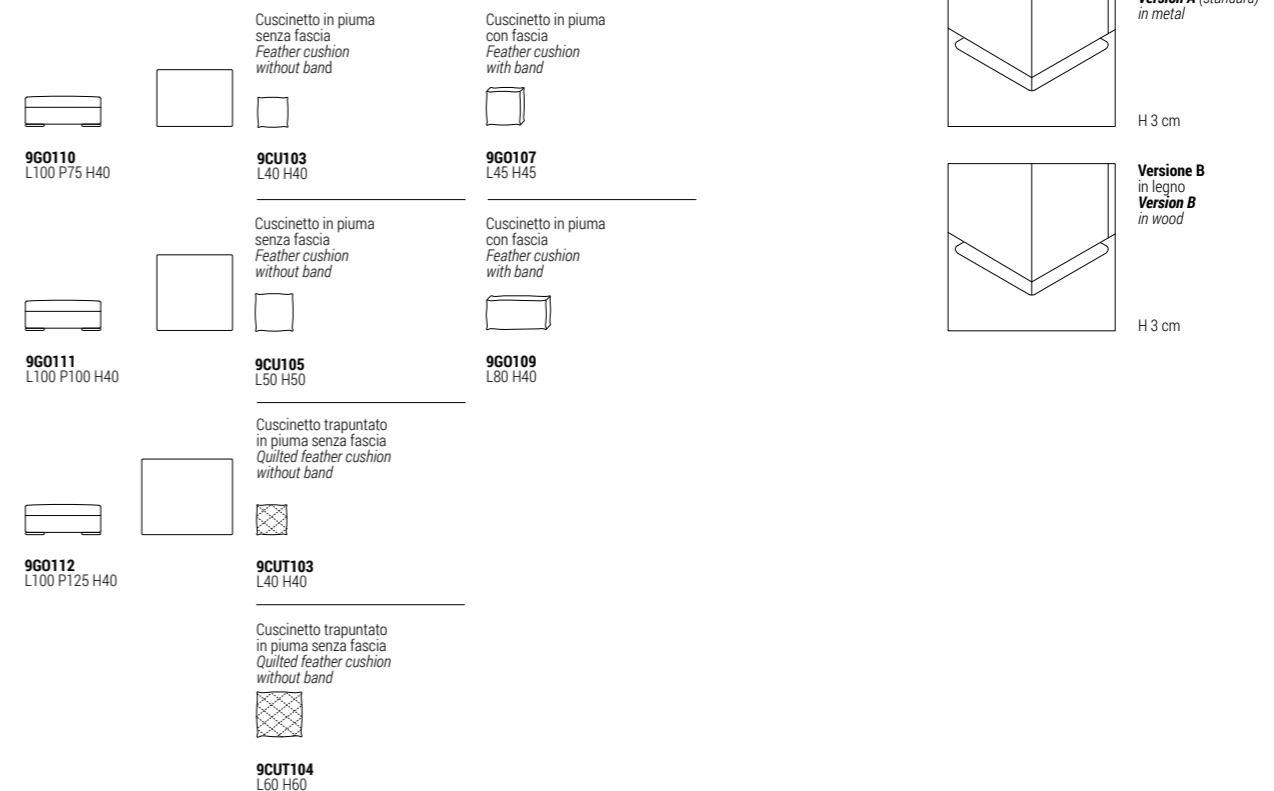

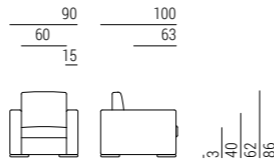

Divani  
Sofas

Elementi componibili  
Modular elements



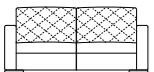
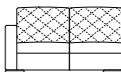





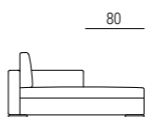
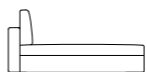
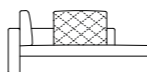
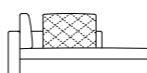
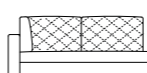

Divani letto  
Sofa-beds

 <b>9GT101</b> L90 P100 H86	 <b>9GT301</b> L115 P100 H86	 <b>9GT207</b> L100 P100 H86	 <b>9GT213</b> L190 P100 H86	 <b>Materasso</b> <i>Mattress</i> L115 P190 H15
 <b>9GT202</b> L170 P100 H86	 <b>9GT302</b> L135 P100 H86	 <b>9GT208</b> L125 P100 H86	 <b>9GT214</b> L210 P100 H86	 <b>Materasso</b> <i>Mattress</i> L145 P190 H15
 <b>9GT203</b> L190 P100 H86	 <b>9GT303</b> L155 P100 H86	 <b>9GT402</b> L140 P100 H86	 <b>9GT215</b> L230 P100 H86	 <b>Materasso</b> <i>Mattress</i> L160 P190 H15
 <b>9GT204</b> L210 P100 H86	 <b>9GT304</b> L175 P100 H86	 <b>9GT403</b> L160 P100 H86	 <b>9GT216</b> L250 P100 H86	 <b>Materasso</b> <i>Mattress</i> L160 P190 H15
 <b>9GT205</b> L230 P100 H86	 <b>9GT305</b> L195 P100 H86	 <b>9GT404</b> L180 P100 H86	 <b>9GT314</b> L175 P100 H86	 <b>Materasso</b> <i>Mattress</i> L115 P190 H15
 <b>9GT206</b> L250 P100 H86	 <b>9GT306</b> L215 P100 H86	 <b>9GT405</b> L200 P100 H86	 <b>9GT315</b> L195 P100 H86	 <b>Materasso</b> <i>Mattress</i> L145 P190 H15
			 <b>9GT316</b> L215 P100 H86	 <b>Materasso</b> <i>Mattress</i> L160 P190 H15

Dormeuse  
Longchair

Pouf e accessori  
Pouf and accessories

Piedini  
Feet

 <b>9GT102</b> L180 P98 H86	 <b>9GT103</b> L180 P98 H86	 <b>9GT104</b> L200 P98 H86	 <b>9GT105</b> L200 P98 H86	 <b>9GT106</b> L225 P98 H86
 <b>9GT110</b> L100 P75 H40	 <b>9GT112</b> L100 P125 H40	 <b>9GT111</b> L100 P100 H40	 <b>9CU103</b> L40 H40	 <b>9CU104</b> L60 H60
			 <b>9CU105</b> L50 H50	 <b>9CU107</b> L45 H45
			 <b>9CU103</b> L40 H40	 <b>9CU109</b> L80 H40

Versione A (standard)  
in metallo  
Version A (standard)  
in metal

H 3 cm

Versione B  
in legno  
Version B  
in wood

H 3 cm

# Gordon Round Quilted

Divani  
Sofas

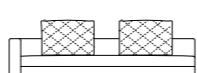
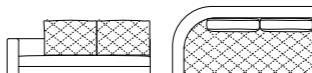
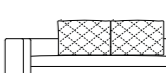
 <b>9GT406</b> L245 P105 H86	 <b>9GT407</b> L187 P105 H86	 <b>9GT408</b> L213 P150 H86
---	---	---

# Gordon Move Quilted

DESIGN  
STUDIO MARELLI  
2014

Movimento schienali  
Backrest mechanism

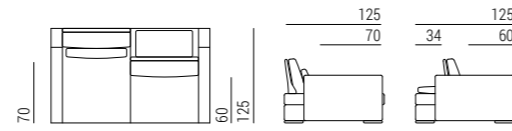

# Gordon Move Quilted

DESIGN  
STUDIO MARELLI  
2014

389

LIFESTYLE COLLECTION 2021 \_ MARELLI

Divani  
Sofas

Elementi componibili  
Modular elements

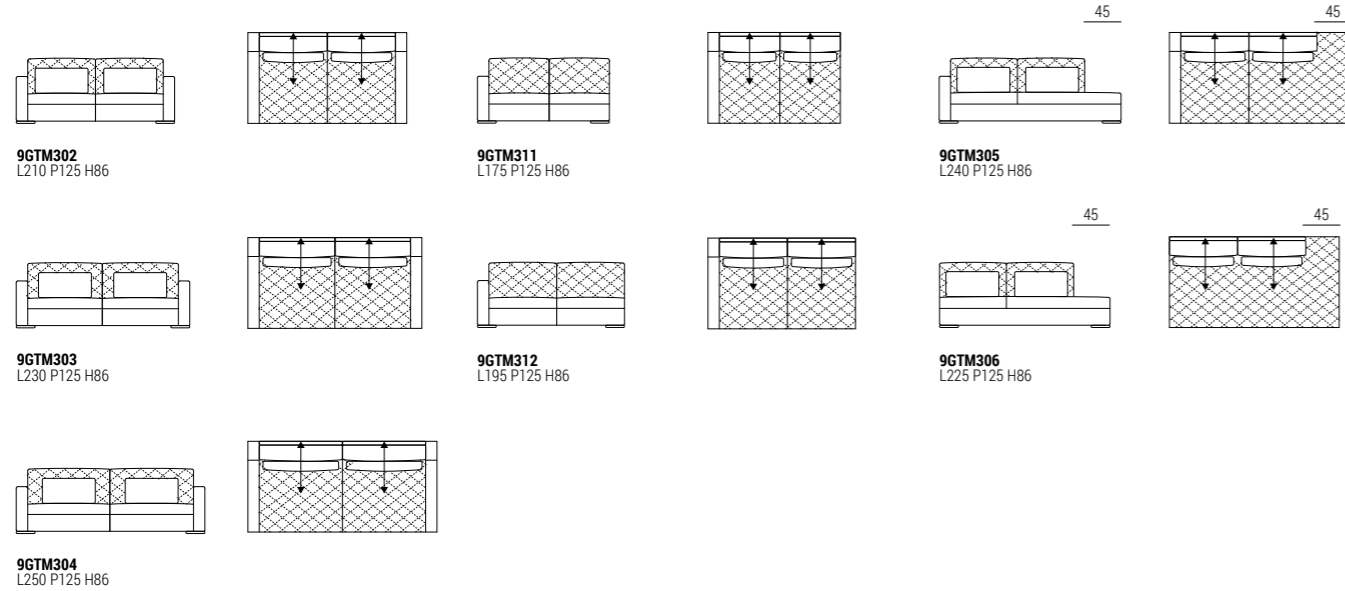

Pouf e accessori  
Pouf and accessories

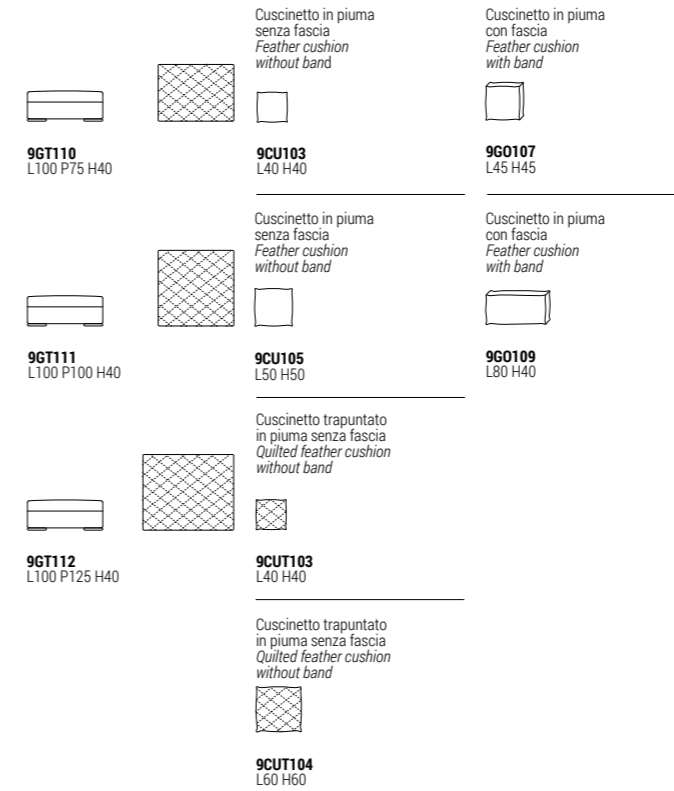

Piedini  
Feet

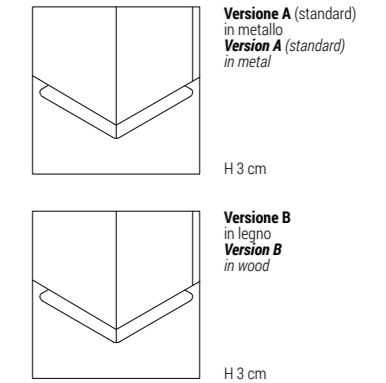

Gli elementi componibili Gordon Move possono essere liberamente combinati con gli elementi Gordon per creare infinite composizioni

The different elements of Gordon Move can be combined with the modular elements of Gordon to create several and different compositions

LIFESTYLE COLLECTION 2021 \_ MARELLI

# Grace

DESIGN  
STUDIO MARELLI  
2019

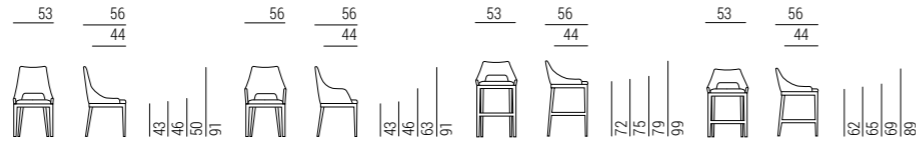

Fusto in legno multistrato di pioppo curvato. Struttura della seduta in legno multistrato con imbottitura in poliuretano espanso a quote differenziate 30 kg/m<sup>3</sup> e 40 kg/m<sup>3</sup>, rivestito in dacron, con cinghie elastiche intrecciate. Rivestimento fisso. La versione standard è dotata di antiscivolanti in PVC. Disponibili a richiesta altri tipi di antiscivolanti, in feltro e plastica.

Car casse en bois multiplis de peuplier courbé. Structure de l'assise en bois multiplis finie de mousse de polyuréthane de différentes densités de 30 kg/m<sup>3</sup> et de 40 kg/m<sup>3</sup> couverte de dacron, muni de bandes élastiques entrecroisées. Revêtement fixe. Equipé de patins en PVC dans la version standard. Disponible sur demande avec d'autres patins, en feutre ou en plastique.

Frame made of curved multi-ply poplar wood. Seat structure made of multi-ply wood, upholstered with polyurethane foam in different densities of 30 Kg/m<sup>3</sup> and 40 Kg/m<sup>3</sup>, covered with dacron, with interwoven elastic belts. Fixed covers. The standard version is equipped with PVC glides. Other kinds of glides in plastic or felt pads are available on demand.

Для производства каркаса используется гнутая многослойная фанера из тополя. Конструкция сиденья выполнена из многослойной фанеры в сочетании с перекрещивающимися эластичными ремнями и наполнением из вспененного пенополиуретана различной степени плотности - 30 кг/м<sup>3</sup> и 40 кг/м<sup>3</sup>, обернутого в дакрон. Чехлы несъемные. В стандартный комплект по умолчанию входят противоскользящие накладки из ПВХ. По запросу возможно их изготовление из войлока или пластика.

Das Gestell besteht aus gebogenem Pappelschichtholz. Sitzstruktur aus Schichtholz, gepolstert mit Polyurethan-Schaumstoff in verschiedenen Dichten 30 Kg/m<sup>3</sup> und 40 Kg/m<sup>3</sup>, mit Dacron ummantelt, mit geflochtenen Gummigurten. Nicole ist immer festbezogen. Standard mit PVC-Gleitern ausgestattet. Andere Gleiter, wie Feltz- oder Kunststoffgleiter, sind auf Anfrage verfügbar.

## Poltrone Armchairs



**9GR101**  
L53 P56 H91



**9GR102**  
L56 P56 H91



**9GR103**  
L53 P56 H74



**9GR104**  
L53 P56 H99



**9GR105**  
L53 P56 H89

## Finiture Finishes

Base in legno  
Wooden base



<b>Code</b>	Cherry stained oak <b>OPR1</b>	Wengé stained oak <b>OPR2</b>	Walnut stained oak <b>OPR3</b>	Natural oak <b>OPR4</b>	Black stained oak <b>OPR5</b>	Cherry Milano stained oak <b>OPR6</b>
-------------	-----------------------------------	----------------------------------	-----------------------------------	----------------------------	----------------------------------	--



<b>Code</b>	Tobacco stained oak <b>OPR8</b>	Grey taupe stained oak <b>OPR9</b>	Whitened oak <b>OPR10</b>	Charcoal stained oak <b>OPR11</b>	Mahogany stained oak <b>OPR12</b>	Moka matt stained oak <b>OPR15</b>
-------------	------------------------------------	---------------------------------------	------------------------------	--------------------------------------	--------------------------------------	---------------------------------------

# Hebo

DESIGN  
GABRIELE CAPPELLETTI  
2016

Tavolo in marmo: Gambe e piano interamente in marmo. Bordi del piano stondati. Tavolo in legno: Gambe in massello di tulipier, piano in MDF ultralight con impiallacciatura in legno lati, nelle finiture marrone opaco e naturale opaco. Bordi del piano smussati.

Table en marbre: Pieds et plateau entièrement en marbre. Bords du plateau rajeunis. Table en bois: Pieds en tulipier massif, plateau en MDF ultralégers avec placage en bois de lati à l'extérieur, disponibles dans les finitions brun foncé et naturel mat. Bords du plateau biseautés.

Marble table: Legs and top are entirely in marble. Rejuvenated and rounded top edge. Wooden table: Solid tulipier wood legs, ultralight MDF top with external veneer in lati wood, available in the finishes matt brown and matt natural. Bevelled top edge.

Русский Стол мраморный: Столешница и ножки целиком выполнены из мрамора. Столешница со скругленной кромкой. Стол деревянный: Ножки: массив тюльпанного дерева, столешница из сверхлегкой МДФ, фанерованной шпоном экзотической породы дерева лати, в натуральной матовой либо коричневой матовой отделке. Кромка столешницы скошенная.

Marmortisch: Beine und Tischplatte komplett aus Marmor. Tischplatte mit gerundeten und verjüngten Kanten. Holztisch: Beine aus Tulipier massiv, Tischplatte aus MDF ultralight mit äusserem Latifurnier in den Ausführungen braun matt und natur matt. Tischplatte mit abgeschrägten Kanten.

## Tavoli Tables

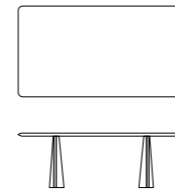

**7HEB101**  
Marble  
**7HEB102**  
Wood  
L220 P120 H72

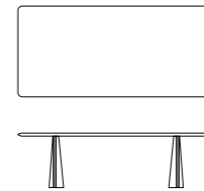

**7HEB103**  
Marble  
**7HEB104**  
Wood  
L260 P120 H72

## Finiture Finishes

Marmo  
Marble



<b>Code</b>	White Carrara marble <b>OPP1</b>	Black Marquinia marble <b>OPP2</b>	Black and gold marble <b>OPP9</b>	Arabescato Vagli marble <b>OPP18</b>	Calacatta Vagli marble <b>OPP19</b>
-------------	-------------------------------------	---------------------------------------	--------------------------------------	---	--

Legno  
Wooden



<b>Code</b>	Cherry stained oak <b>OPR1</b>	Wengé stained oak <b>OPR2</b>	Walnut stained oak <b>OPR3</b>	Natural oak <b>OPR4</b>	Black stained oak <b>OPR5</b>	Cherry Milano stained oak <b>OPR6</b>
-------------	-----------------------------------	----------------------------------	-----------------------------------	----------------------------	----------------------------------	--



<b>Code</b>	Tobacco stained oak <b>OPR8</b>	Grey taupe stained oak <b>OPR9</b>	Whitened oak <b>OPR10</b>	Charcoal stained oak <b>OPR11</b>	Mahogany stained oak <b>OPR12</b>	Moka matt stained oak <b>OPR15</b>
-------------	------------------------------------	---------------------------------------	------------------------------	--------------------------------------	--------------------------------------	---------------------------------------

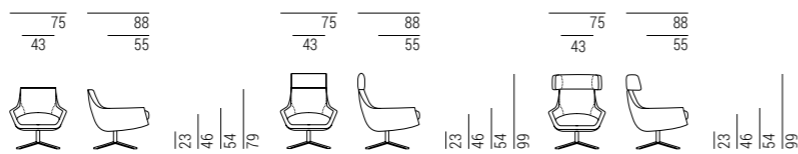

Struttura in tubolare di metallo ricoperto con schiuma di poliuretano a freddo ignifugo, classe 1IM, rivestito con una fodera in fibra acrilica. Cuscino di seduta in poliuretano espanso con densità 40 kg/m<sup>3</sup> (5,9 KPA), rivestito in fibra acrilica. Il rivestimento è sempre fisso.

Structure en métal tubulaire recouvert de mousse à froid ignifuge classe 1IM, recouverte d'une housse en fibre acrylique. Coussin d'assise en mousse de polyuréthane avec une densité de 40 kg/m<sup>3</sup> (5,9 kPa), recouverte de fibre acrylique. Le revêtement est toujours fixe.

Metal tube structure upholstered with cold injected fire retardant polyurethane foam class 1IM, covered with acrylic fibre. Seat cushion in polyurethane foam with density 40 kg/m<sup>3</sup> (5,9 KPA), lined with acrylic fibre. Fixed covers.

Каркас выполнен из профильной металлической трубы, покрытой слоем огнестойкого пенополиуретана холодного формования, класс 1 IM, и помещенной в чехол из акрилового воловкна. Наполнение подушки сиденья выполнено из вспененного полиуретана плотностью 40 кг/м<sup>3</sup> (5,9 кПа), помещенного в чехол из акрилового волокна. Обивка только несъемная.

Struktur der Sitzschale in Metall überschäumt mit Polyurethan-Kaltschaumstoff, Feuerwiderstandsklasse 1IM, mit Acrylfaser ummantelt. Sitzkissen aus Polyurethan-Schaumstoff mit Dichte 40 Kg/m<sup>3</sup> (5,9 KPA), mit Acrylfaser ummantelt. Bezüge immer fix, nicht abziehbar.

## Poltrone girevoli Swivel armchairs



**9JY104**  
L75 P82 H99  
Poltrona girevole  
con schienale alto  
Swivel high  
wingback chair



**9JY101**  
L75 P82 H99  
Poltrona girevole  
con schienale alto  
Swivel armchair  
with high back



**9JY102**  
L75 P82 H79  
Poltrona girevole  
con schienale basso  
Swivel armchair  
with low back

## Poltrone Armchairs



**9JY107**  
L75 P82 H99  
Poltrona  
con schienale alto  
High wingback chair



**9JY106**  
L75 P82 H99  
Poltrona  
con schienale alto  
Armchair with high back



**9JY105**  
L75 P82 H79  
Poltrona  
con schienale basso  
Armchair with low back



**9JY108**  
L75 P82 H79  
Poltrona girevole  
con schienale basso  
Swivel armchair  
with low back

## Pouf girevole Swivel ottoman



**9JY103**  
L60 P44 H39  
Pouf girevole  
Swivel pouf

## Basi girevoli Swivel bases

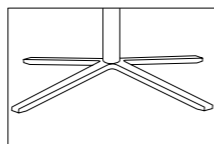

**Versione A** tubolare in metallo  
Version A tubular in metal

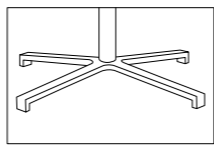

**Versione B** tubolare in metallo  
Version B tubular in metal

## Finiture Finishes

Base girevole in metallo A  
Swivel metal base A



**Code**  
Shiny chrome metal **OPM1**  
Brushed matt chrome metal **OPM2**  
Brushed matt dark grey metal **OPM3**  
RAL 9017 black painted metal **OPM6**  
RAL 9016 white painted metal **OPM7**  
Classic bronze painted metal **OPM9**  
Golden beach painted metal **OPM10**  
Gold pearl painted metal **OPM11**



**Code**  
Brushed copper metal **OPM12**  
Brushed antique brass metal **OPM13**  
Shiny black chrome metal **OPM14**  
Brushed antique gold metal **OPM15**  
Shiny brass chrome metal **OPM16**  
Bronze metal **OPM17**  
Anodyc Bronze painted metal **OPM18**

Base girevole in metallo B  
Swivel metal base B



**Code**  
Shiny chrome metal **OPM1**  
Brushed matt chrome metal **OPM2**  
RAL 9017 black painted metal **OPM6**  
Classic bronze painted metal **OPM9**

**9JY105**  
**9JY106**  
**9JY107**  
**9JY108**  
Base in metallo  
Metal base



**Code**  
RAL 9017 traffic black painted metal **OPM6**  
Classic bronze painted metal **OPM9**  
Golden beach painted metal **OPM10**  
Gold pearl painted metal **OPM11**  
Anodyc Bronze metal **OPM18**

## Tavolini Coffee tables



**7KY101**  
Top marmo/Marble top  
**7KY102**  
Top vetro/Glass top  
Ø40 H48



**7KY103**  
Top marmo/Marble top  
**7KY104**  
Top vetro/Glass top  
Ø50 H38



**7KY105**  
Top marmo/Marble top  
**7KY106**  
Top vetro/Glass top  
Ø50 H48

Top: vetro extra light temperato, spessore 6 mm  
Top: extralight tempered glass, 6 mm thick

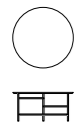
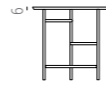

**7KY107**  
Top marmo/Marble top  
**7KY108**  
Top vetro/Glass top  
Ø80 H38

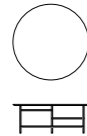

**7KY109**  
Top marmo/Marble top  
**7KY110**  
Top vetro/Glass top  
Ø100 H38

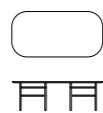

**7KY111**  
Top marmo/Marble top  
**7KY112**  
Top vetro/Glass top  
L120 P60 H38



**7KY113**  
Top marmo/Marble top  
**7KY114**  
Top vetro/Glass top  
L80 P80 H38

## Tavoli da pranzo Dining tables

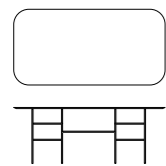

**7KY201**  
Top marmo/Marble top  
**7KY202**  
Top legno/Wooden top  
L200 P110 H74

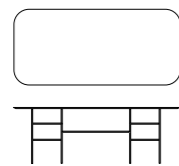

**7KY203**  
Top marmo/Marble top  
**7KY204**  
Top legno/Wooden top  
L220 P110 H74

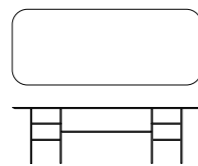

**7KY205**  
Top marmo/Marble top  
**7KY206**  
Top legno/Wooden top  
L250 P110 H74

## Madia Sideboard

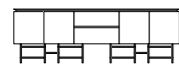

**7KY207**  
Top superiore in marmo  
Marble upper top  
**7KY307**  
Top superiore in vetro  
Glass upper top  
L220 P50 H71

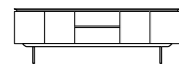

**7KY212**  
Top superiore in marmo  
Marble upper top  
**7KY312**  
Top superiore in vetro  
Glass upper top  
L220 P50 H71



**7KY208**  
Top superiore in marmo  
Marble upper top  
**7KY308**  
Top superiore in vetro  
Glass upper top  
L220 P50 H50

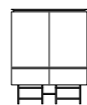

**7KY209**  
Top superiore in marmo  
Marble upper top  
**7KY309**  
Top superiore in vetro  
Glass upper top  
L100 P50 H125

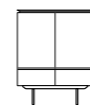

**7KY211**  
Top superiore in marmo  
Marble upper top  
**7KY311**  
Top superiore in vetro  
Glass upper top  
L100 P50 H125



**7KY210**  
Top superiore in marmo  
Marble upper top  
**7KY310**  
Top superiore in vetro  
Glass upper top  
L100 P50 H105

## Credenza Cupboard

Top: vetro extra light temperato, spessore 6 mm  
Top: extralight tempered glass, 6 mm thick

Top: marmo, spessore 20 mm  
Top: marble, 20 mm thick



## Finiture Finishes

Top in marmo  
Marble top



**Code**  
White Carrara marble **OPP1**  
Black Marquina marble **OPP2**  
Brown Emperador marble **OPP3**  
Grey Serena stone **OPP4**  
Beige Brera stone **OPP5**  
Calacatta gold marble **OPP7**  
Black and gold marble **OPP9**  
Perfetto brown marble **OPP10**  
Grey Stone marble **OPP11**  
Guatemala green marble **OPP12**

**Code**

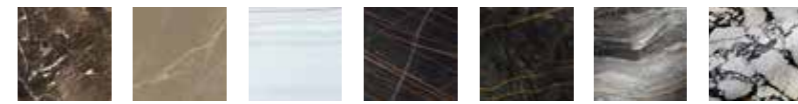

Velvet brown marble **OPP13**  
Amani Bronze marble **OPP14**  
Covelano white marble **OPP15**  
Sahara noir marble **OPP16**  
Port Laurent marble **OPP17**  
Arabescato orobico grey marble **OPP20**  
Calacatta violet marble **OPP21**

Top in Gres Porcellanato  
Porcelain Stoneware Top



**Code**  
Nero Marquina **OPG2**  
Statuario Select **OPG3**  
Calacatta Royal **OPG4**  
Bianco Dolomite **OPG5**

Top in vetro  
Glass top



**Code**  
Transparent glass **OPV1**  
Frosted glass **OPV2**  
RAL 9016 traffic white back-painted glass **OPV3**  
RAL 9017 traffic black back-painted glass **OPV4**  
RAL 7044 silk grey back-painted glass **OPV5**  
RAL 1019 grey beige back-painted glass **OPV6**  
Chrome back-painted bronze glass **OPV9**  
Chrome back-painted grey glass **OPV10**  
Transparent bronze glass **OPV12**  
Transparent grey glass **OPV13**

Top in rovere impiallacciato  
Oak veneer top



**Code**  
Cherry stained oak **OPR1**  
Wengé stained oak **OPR2**  
Walnut stained oak **OPR3**  
Natural oak **OPR4**  
Black stained oak **OPR5**  
Cherry Milano stained oak **OPR6**  
Tobacco stained oak **OPR8**  
Grey taupe stained oak **OPR9**  
Whitened oak **OPR10**  
Charcoal stained oak **OPR11**

Struttura madia/credenza  
Sideboard/cupboard structure



**Code**  
Moka matt stained oak **OPR15**

Base e puntali in metallo  
Metal base and tips

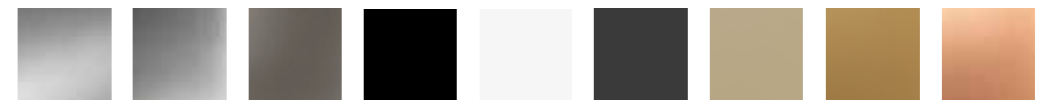

**Code**  
Shiny chrome metal **OPM1**  
Brushed matt chrome metal **OPM2**  
Brushed matt dark grey metal **OPM3**  
RAL 9017 black painted metal **OPM6**  
RAL 9016 white painted metal **OPM7**  
Classic bronze painted metal **OPM9**  
Golden beach painted metal **OPM10**  
Gold pearl painted metal **OPM11**  
Brushed copper metal **OPM12**

**Code**  
Brushed antique brass metal **OPM13**  
Shiny black chrome metal **OPM14**  
Brushed antique gold metal **OPM15**  
Shiny brass chrome metal **OPM16**  
Bronze metal **OPM17**  
Anodyc Bronze metal **OPM18**

# Lobel Bookshelf

DESIGN  
GABRIELE CAPPELLETTI  
2014

396

LIFESTYLE COLLECTION 2021 \_ MARELLI

Libreria  
Bookshelf

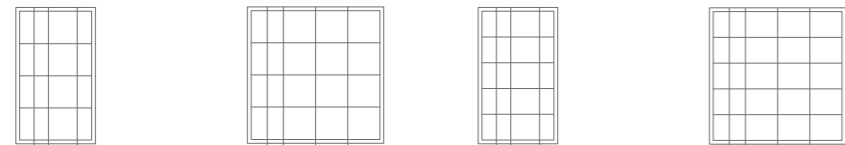

**7LOB101** L104 P45 H185  
**7LOB102** L180 P45 H185  
**7LOB103** L104 P45 H185  
**7LOB104** L180 P45 H185

Finiture  
Finishes

Struttura in metallo Metal structure										
<b>Code</b>	Shiny chrome metal <b>OPM1</b>	Brushed matt chrome metal <b>OPM2</b>	Brushed matt dark grey metal <b>OPM3</b>	RAL 9017 black painted metal <b>OPM6</b>	RAL 9016 white painted metal <b>OPM7</b>	Classic bronze painted metal <b>OPM9</b>	Golden beach painted metal <b>OPM10</b>	Gold pearl painted metal <b>OPM11</b>		
<b>Code</b>	Brushed copper metal <b>OPM12</b>	Brushed antique brass metal <b>OPM13</b>	Shiny black chrome metal <b>OPM14</b>	Brushed antique gold metal <b>OPM15</b>	Shiny brass chrome metal <b>OPM16</b>	Bronze metal <b>OPM17</b>	Anodyc. Bronze metal <b>OPM18</b>			
Top in vetro Glass top										
<b>Code</b>	Transparent glass <b>OPV1</b>	Frosted glass <b>OPV2</b>	RAL 9016 traffic white back-painted glass <b>OPV3</b>	RAL 9017 traffic black back-painted glass <b>OPV4</b>	RAL 7044 silk grey back-painted glass <b>OPV5</b>	RAL 1019 grey beige back-painted glass <b>OPV6</b>	Chrome back-painted bronze glass <b>OPV9</b>	Chrome back-painted grey glass <b>OPV10</b>	Transparent bronze glass <b>OPV12</b>	Transparent grey glass <b>OPV13</b>

# Loft 100/110

DESIGN  
STUDIO MARELLI  
2013

397

LIFESTYLE COLLECTION 2021 \_ MARELLI

Fusto in legno massello e legno multistrato con cinghie elastiche intrecciate. Imbottitura in poliuretano espanso rivestito in vellutino bianco. Cuscini di schienale in Piumafib, una speciale miscela ipoallergenica di vera piuma e fibra poliestere siliconata\*. Cuscini di seduta costituiti da un inserto in poliuretano con densità di 30 Kg/m<sup>3</sup> ricoperto da un trapuntino di vera piuma imbottito a scomparti\*. Completamente sfoderabile in tessuto, non sfoderabile in pelle e finta pelle.  
Kit letto non disponibile.  
Disponibile con profondità di seduta 100/110 cm  
\*Manutenzione dei cuscini contenenti piuma:  
I cuscini contenenti piuma tendono a deformarsi con l'utilizzo. Per mantenerne la forma è necessario, anche dopo un breve utilizzo, battere e sprimacciare ripetutamente i cuscini. Non utilizzare mai battipanni o aspirapolvere. A coloro che non desiderassero seguire queste indicazioni o che volessero un divano dall'aspetto meno vissuto, raccomandiamo di preferire dei cuscini in gomma.

Carcasse en bois massif et multiplis muni de bandes élastiques entrecroisées et finie de mousse polyuréthane couverte de dacron. Coussins de dossier en Piumafib, un mélange hypoallergénique spécial de véritable duvet et fibre polyester siliconisée\*. Les coussins d'assise sont composés d'un noyau en mousse polyuréthane d'une densité de 30 kg/m<sup>3</sup> couvert de véritable duvet broché en compartiments\*. Revêtement complètement déhoussable en tissu, fixe en cuir et cuir look. Pas disponible en canapé-lit.  
Profondeurs d'assise disponibles: cm 100/110  
\*Entretien de coussins en duvet:  
Coussins en duvet ont tendance à perdre leur forme dû à l'usage. Pour en conserver la forme il est nécessaire, aussi après un usage court, de régulièrement battre les coussins. Ne jamais utiliser la tapette ou l'aspirateur. A ceux qui ne désirent pas suivre ces indications ou qui souhaitent un canapé qui ait l'air moins "usé", nous conseillons vivement de choisir des coussins en mousse polyuréthane.

Frame made of solid wood and multi-ply wood with interwoven elastic straps. The upholstery is made of polyurethane foam, covered with dacron. The back cushions are filled with Piumafib, a special hypoallergenic mixture of feathers and siliconised polyfibre\*. The seat cushions are made of a foam insert with density of 30 Kg/m<sup>3</sup>, covered with a feather compartments quilt\*. Fully removable fabric covers, fixed leather and artificial leather covers.  
Sofa-bed is not available.  
Available seat depths: 100/110 cm  
\*Maintenance of feather cushions:  
Cushions filled with feathers tend to change their shape with use. In order to keep their shape it is necessary, even after a short use, to plump up the cushions repeatedly. Never use carpet beater or vacuum cleaner. We recommend to choose foam cushions to those who do not wish to follow these instructions or to have a "used look" sofa.

Для производства каркаса используется массив дерева и многослойная фанера в сочетании с перекрещивающимися эластичными ремнями. Наполнение из полиуретана, обернутого в белый бархат. Наполнение подушек спинки выполнено из материала Piumafib – специальной, не вызывающей аллергию смеси из натурального пуха и полиэфирных силиконовых волокон\*. Подушки сиденья: стеганые по отсекам, наполнение из натурального пуха с вставками из полиуретана плотностью 30 кг/м<sup>3</sup>\*. Полностью съемные чехлы из ткани, несъемные чехлы из кожи.

Das Gestell besteht aus Massiv- und Schichtholz, mit geflochtenen Gummigurten, gepolstert mit Polyurethanschaumstoff, mit Dacron bezogen. Ruckenkissen aus Piumafib, einer hypoallergischen speziellen Mischung aus echter Daune und silikonisierter Polyesterfaser\*. Die Sitzkissen bestehen aus einem Schaumkern mit Dichte 30 Kg/m<sup>3</sup> mit einer gekammerten Daunenaufgabe\*. Stoffbezüge alle abziehbar, Leder und Kunstleder festbezogen. Als Bettsofa nicht verfügbar.  
Lieferbare Sitztiefen: 100/110 cm  
Wartungsanleitungen fuer Daunen-kissen:  
Die Kissen, die Daunen enthalten, neigen dazu, sich durch Gebrauch zu verformen. Um die ursprüngliche Form zu halten, ist es notwendig, auch nach kurzem Gebrauch, die Kissen wiederholt aufzuschütteln. Keinen Ausklopfer oder Staubsauger verwenden. Unseren Kunden, die diese Anweisungen nicht befolgen moechten, oder die kein Sofa mit solchem "gebrauchten" Aussehen haben moechten, empfehlen wir Polyurethan-Kissen.

Вариант со спальным местом не предусмотрен. Возможные варианты по глубине: 100/110 см  
\*Эксплуатация подушек с пуховым наполнением: В процессе эксплуатации подушки с пуховым наполнением могут деформироваться, во избежание чего их необходимо слегка взбивать вручную даже после непродолжительного нахождения на диване. Использование в этих целях пылесоса или выбивалки для одежды категорически запрещено. Если клиент не планирует следовать данным инструкциям и хочет, чтобы подушки сиденья и спинки проминались по минимуму, посоветуйте выбрать наполнение только из полиуретана, полностью исключив натуральный пух.



# Loft 100

DESIGN  
STUDIO MARELLI  
2013

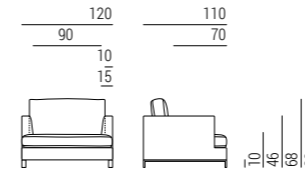
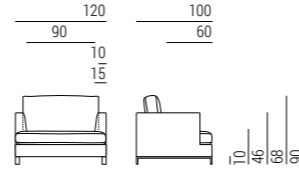

# Loft 110

DESIGN  
STUDIO MARELLI  
2013

399

LIFESTYLE COLLECTION 2021 \_ MARELLI

Divani  
Sofas

Elementi componibili  
Modular elements



**9LT101**  
L120 P100 H90



**9LT102**  
L105 P100 H90



**9LT103**  
L90 P100 H90

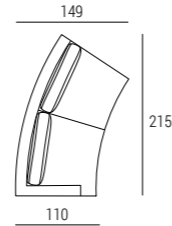

**9LT217**  
L215 P149 H90  
Elemento curvo  
Curved element

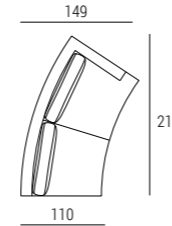

**9LT218**  
L215 P149 H90  
Elemento curvo  
Curved element

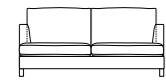

**9LT201**  
L190 P100 H90

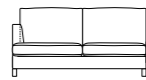

**9LT211**  
L175 P100 H90

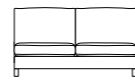

**9LT214**  
L160 P100 H90

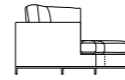

**9LT217**  
L215 P149 H90  
Elemento curvo  
Curved element

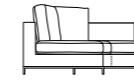

**9LT218**  
L215 P149 H90  
Elemento curvo  
Curved element

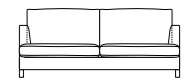

**9LT202**  
L210 P100 H90

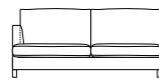

**9LT212**  
L195 P100 H90

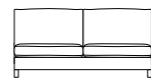

**9LT215**  
L180 P100 H90

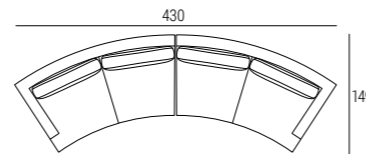

Composizione tipo  
Suggested composition

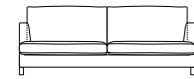

**9LT203**  
L230 P100 H90

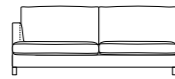

**9LT219**  
L215 P100 H90

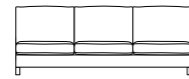

**9LT216**  
L230 P100 H90

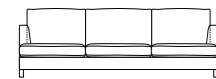

**9LT204**  
L260 P100 H90

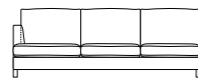

**9LT213**  
L245 P100 H90



Elemento angolare  
Corner element

**9LT104**  
L100 P100 H90

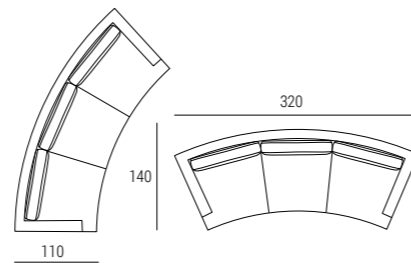

**9LT220**  
L320 P140 H90  
Divano curvo  
Curved sofa

Divani  
Sofas

Elementi componibili  
Modular elements

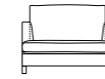

**9LJ101**  
L120 P110 H90

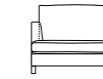

**9LJ102**  
L105 P110 H90



**9LJ103**  
L90 P110 H90

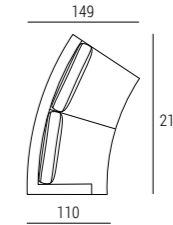

**9LT217**  
L215 P149 H90  
Elemento curvo  
Curved element

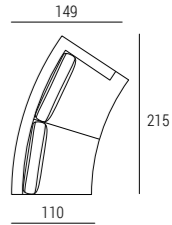

**9LT218**  
L215 P149 H90  
Elemento curvo  
Curved element

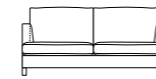

**9LJ201**  
L190 P110 H90

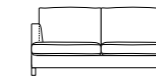

**9LJ211**  
L175 P110 H90

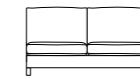

**9LJ214**  
L160 P110 H90

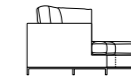

**9LJ217**  
L215 P149 H90  
Elemento curvo  
Curved element

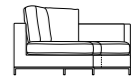

**9LJ218**  
L215 P149 H90  
Elemento curvo  
Curved element

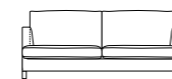

**9LJ202**  
L210 P110 H90

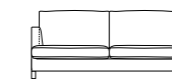

**9LJ212**  
L195 P110 H90

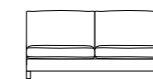

**9LJ215**  
L180 P110 H90

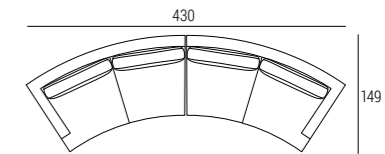

Composizione tipo  
Suggested composition

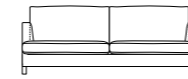

**9LJ203**  
L230 P110 H90

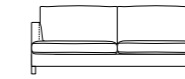

**9LJ219**  
L215 P110 H90

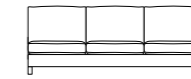

**9LJ216**  
L230 P110 H90

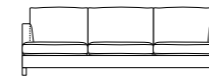

**9LJ204**  
L260 P110 H90

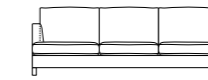

**9LJ213**  
L245 P110 H90

Elemento angolare  
Corner element



**9LJ104**  
L110 P110 H90

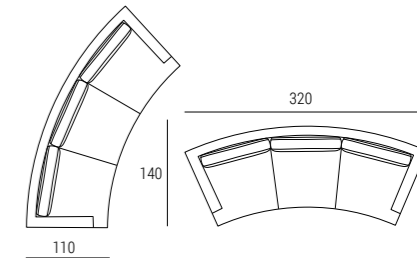

**9LT220**  
L320 P140 H90  
Divano curvo  
Curved sofa

Le misure delle altezze si riferiscono al modello con base A standard  
The height sizes are referred to the model with standard base A

Le misure delle altezze si riferiscono al modello con base A standard  
The height sizes are referred to the model with standard base A

LIFESTYLE COLLECTION 2021 \_ MARELLI

# Loft 100/110

DESIGN  
STUDIO MARELLI  
2013

# Loft 100/110

DESIGN  
STUDIO MARELLI  
2013

400

LIFESTYLE COLLECTION 2021 \_ MARELLI

Dormeuse  
Longchair

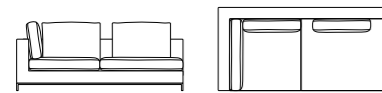

**9LT105**  
L220 P110 H90

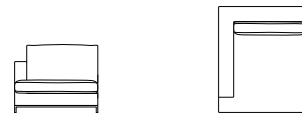

**9LT112**  
L115 P140 H90



**9LT113**  
L100 P200 H90

Pouf e accessori  
Ottomans and accessories



**9LT107**  
L110 P110 H46



**9LT108**  
L100 P100 H46

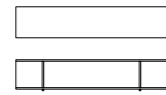

**7LT101**  
L200 P40 H41



Cuscinetto in piuma  
senza fascia  
Feather cushion  
without band

**9CU103**  
L40 H40

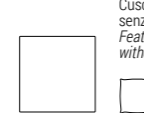

Cuscinetto in piuma  
senza fascia  
Feather cushion  
without band

**9CU106**  
L45 H45

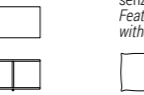

Cuscinetto in piuma  
senza fascia  
Feather cushion  
without band

**9CU105**  
L50 H50



Cuscinetto in piuma  
senza fascia  
Feather cushion  
without band

**9CU104**  
L60 H60

Piedini  
Feet

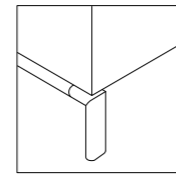

**Versione A**  
in metallo  
**Version A**  
in metal

H 10 cm

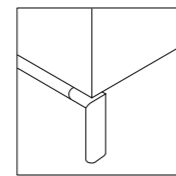

**Versione A**  
in rovere  
**Version A**  
in oak

H 10 cm

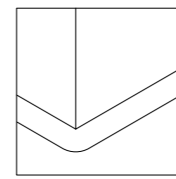

**Versione C**  
in rovere  
**Version C**  
in oak

H 5 cm

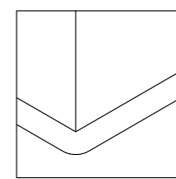

**Versione D**  
in metallo  
**Version D**  
in metal

H 5 cm

Finiture  
Finishes

**Versione A + D** (standard)  
in metallo  
**Version A + D** (standard)  
in metal



Code

Shiny chrome metal **OPM1** | Brushed matt chrome metal **OPM2** | Brushed matt dark grey metal **OPM3** | RAL 9017 black painted metal **OPM6** | Classic bronze painted metal **OPM9** | Golden beach painted metal **OPM10** | Gold pearl painted metal **OPM11**



Code

Brushed copper metal **OPM12** | Brushed antique brass metal **OPM13** | Shiny black chrome metal **OPM14** | Brushed antique gold metal **OPM15** | Shiny brass chrome metal **OPM16** | Bronze metal **OPM17** | Anodized Bronze **OPM18**

**Versione A + C + 7LT101**  
(optional)  
in rovere  
**Version A + C + 7LT101**  
(optional)  
in oak



Code

Cherry stained oak **OPR1** | Wengé stained oak **OPR2** | Walnut stained oak **OPR3** | Natural oak **OPR4** | Black stained oak **OPR5** | Cherry Milano stained oak **OPR6**



Code

Tobacco stained oak **OPR8** | Grey taupe stained oak **OPR9** | Whitened oak **OPR10** | Charcoal stained oak **OPR11** | Mahogany stained oak **OPR12** | Moka matt stained oak **OPR15**

401

LIFESTYLE COLLECTION 2021 \_ MARELLI

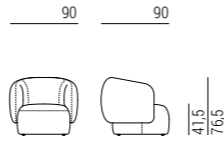

Fusto in legno massello e legno multistrato con cinghie elastiche intrecciate. Imbottitura della seduta in poliuretano espanso con densità 40 kg/m<sup>3</sup> rivestito in dacron. Imbottitura dello schienale in poliuretano espanso a quote differenziate con densità di 30 kg/m<sup>3</sup> e 40 kg/m<sup>3</sup>, rivestito in dacron. Rivestimento fisso.

*Carcasse en bois massif et multiplis munie de bandes élastiques entrecroisées. Assise rembourrée en mousse de polyuréthane d'une densité de 40 kg/m<sup>3</sup> couverte de dacron. Dossier rembourré en mousse polyuréthane de différentes densités de 30 kg/m<sup>3</sup> et 40 kg/m<sup>3</sup> couverte de dacron. Revêtement fixe.*

Frame made of solid wood and plywood with interwoven elastic belts. Seat upholstered with polyurethane foam with density of 40 kg/m<sup>3</sup>, covered with dacron. Back upholstered with polyurethane foam with different densities of 30 kg/m<sup>3</sup> and 40 kg/m<sup>3</sup>, covered with dacron. Fixed covers.

Для производства каркаса используется массив дерева и многослойная фанера в сочетании с перекрещивающимися эластичными ремнями. Наполнение сиденья из вспененного пенополиуретан плотностью - 30 кг/м<sup>3</sup>, обернутого в дакрон. Наполнение спинки из вспененного пенополиуретана различной степени плотности - 30 кг/м<sup>3</sup> и 40 кг/м<sup>3</sup>, обернутого в дакрон. Чехлы несъемные.

Das Gestell besteht aus Massiv- und Schichtholz, mit geflochtenen Gummigurten. Sitz gepolstert mit Polyurethan-Schaumstoff 40 Kg/m<sup>3</sup>, mit Dacron bezogen. Rücken gepolstert mit Polyurethan-Schaumstoff in verschiedenen Dichten 30 Kg/m<sup>3</sup> und 40 Kg/m<sup>3</sup>, mit Dacron bezogen. Ribot ist immer festbezogen.

## Divani Sofas

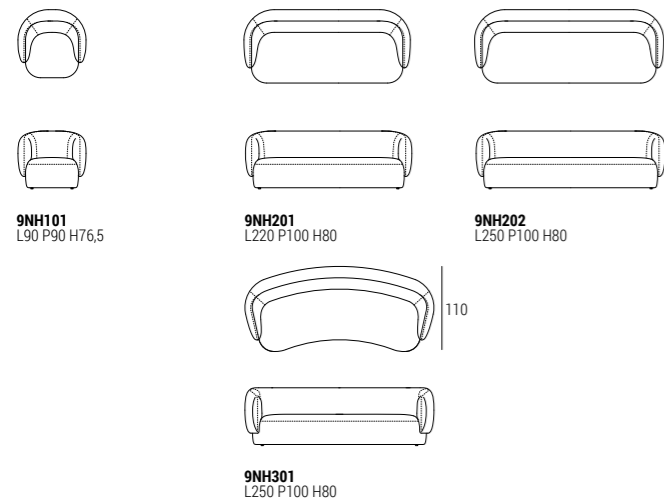

## Dormeuse Longchair

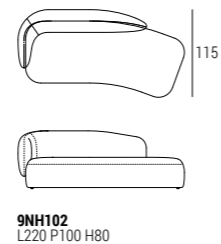

Fusto in legno massello e legno multistrato con cinghie elastiche intrecciate. Imbottitura in poliuretano espanso rivestito in vellutino bianco. Cuscini di schienale in Piumafib, una speciale miscela ipoallergenica di vera piuma e fibra poliestere siliconata\*. Cuscini di seduta costituiti da un inserto in poliuretano con densità di 30 Kg/m<sup>3</sup> ricoperto da un trapuntino di vera piuma imbottito a scomparti\*. Completamente sfoderabile in tessuto, non sfoderabile in pelle e finta pelle. Kit letto non disponibile. \*Manutenzione dei cuscini contenenti piuma: I cuscini contenenti piuma tendono a deformarsi con l'utilizzo. Per mantenerne la forma è necessario, anche dopo un breve utilizzo, battere e sprimacciare ripetutamente i cuscini. Non utilizzare mai battipanni o aspirapolvere. A coloro che non desiderassero seguire queste indicazioni o che volessero un divano dall'aspetto meno vissuto, raccomandiamo di preferire dei cuscini in gomma.

*Carcasse en bois massif et multiplis muni de bandes élastiques entrecroisées et finie de mousse polyuréthane couverte de dacron. Coussins de dossier en Piumafib, un mélange hypoallergénique spécial de véritable duvet et fibre polyester siliconisée\*. Les coussins d'assise sont composés d'un noyau en mousse polyuréthane d'une densité de 30 kg/m<sup>3</sup> couvert de véritable duvet broché en compartiments\*. Revêtement complètement déhoussable en tissu, fixe en cuir et cuir look. Pas disponible en canapé-lit. \*Entretien de coussins en duvet: Coussins en duvet ont tendance à perdre leur forme dû à l'usage. Pour en conserver la forme il est nécessaire, aussi après un usage court, de régulièrement battre les coussins. Ne jamais utiliser la tapette ou l'aspirateur. A ceux qui ne désirent pas suivre ces indications ou qui souhaitent un canapé qui ait l'air moins "usé", nous conseillons vivement de choisir des coussins en mousse polyuréthane.*

Frame made of solid wood and multi-ply wood with interwoven elastic straps. The upholstery is made of polyurethane foam, covered with dacron. The back cushions are filled with Piumafib, a special hypoallergenic mixture of feathers and siliconised polyfibre\*. The seat cushions are made of a foam insert with density of 30 Kg/m<sup>3</sup>, covered with a feather compartments quilt\*. Fully removable fabric covers, fixed leather and artificial leather covers. Sofa-bed is not available. \*Maintenance of feather cushions: Cushions filled with feathers tend to change their shape with use. In order to keep their shape it is necessary, even after a short use, to plump up the cushions repeatedly. Never use carpet beater or vacuum cleaner. We recommend to choose foam cushions to those who do not wish to follow these instructions or to have a "used look" sofa.

Для производства каркаса используется массив дерева и многослойная фанера в сочетании с перекрещивающимися эластичными ремнями. Наполнение из полиуретана, обернутого в белый бархат. Наполнение подушек спинки выполнено из материала Piumafib – специальной, не вызывающей аллергию смеси из натурального пуха и полиэфирных силиконовых волокон\*. Подушки сиденья: стеганые по отсекам, наполнение из натурального пуха с вставками из полиуретана плотностью 30 кг/м<sup>3</sup> \*. Полностью съемные чехлы из ткани, несъемные чехлы из кожи.

Das Gestell besteht aus Massiv- und Schichtholz, mit geflochtenen Gummigurten, gepolstert mit Polyurethanschaumstoff, mit Dacron bezogen. Rueckenkissen aus Piumafib, einer hypoallergenischen speziellen Mischung aus echter Daune und silikonisierter Polyesterfaser\*. Die Sitzkissen bestehen aus einem Schaumkern mit Dichte 30 Kg/m<sup>3</sup> mit einer gekammerten Daunenaufgabe\*. Stoffbezeuge alle abziehbar, Leder und Kunstleder festbezogen. Als Bettsofa nicht verfügbar. Wartungsanleitungen fuer Daunenkissen: Die Kissen, die Daunen enthalten, neigen dazu, sich durch Gebrauch zu verformen. Um die urspruengliche Form zu halten, ist es notwendig, auch nach kurzem Gebrauch, die Kissen wiederholt aufzuschuetteln. Keinen Ausklopfen oder Staubsauger verwenden. Unseren Kunden, die diese Anweisungen nicht befolgen moechten, oder die kein Sofa mit solchem "gebrauchten" Aussehen haben moechten, empfehlen wir Polyurethan-Kissen.

Вариант со спальным местом не предусмотрен. \*Эксплуатация подушек с пуховым наполнением: В процессе эксплуатации подушки с пуховым наполнением могут деформироваться, во избежание чего их необходимо слегка взбивать вручную даже после непродолжительного нахождения на диване. Использование в этих целях пылесоса или выбивалки для одежды категорически запрещено. Если клиент не планирует следовать данным инструкциям и хочет, чтобы подушки сиденья и спинки проминались по минимуму, посоветуйте выбрать наполнение только из полиуретана, полностью исключив натуральный пух.

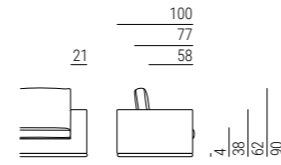

Divani  
Sofas

Elementi componibili  
Modular elements

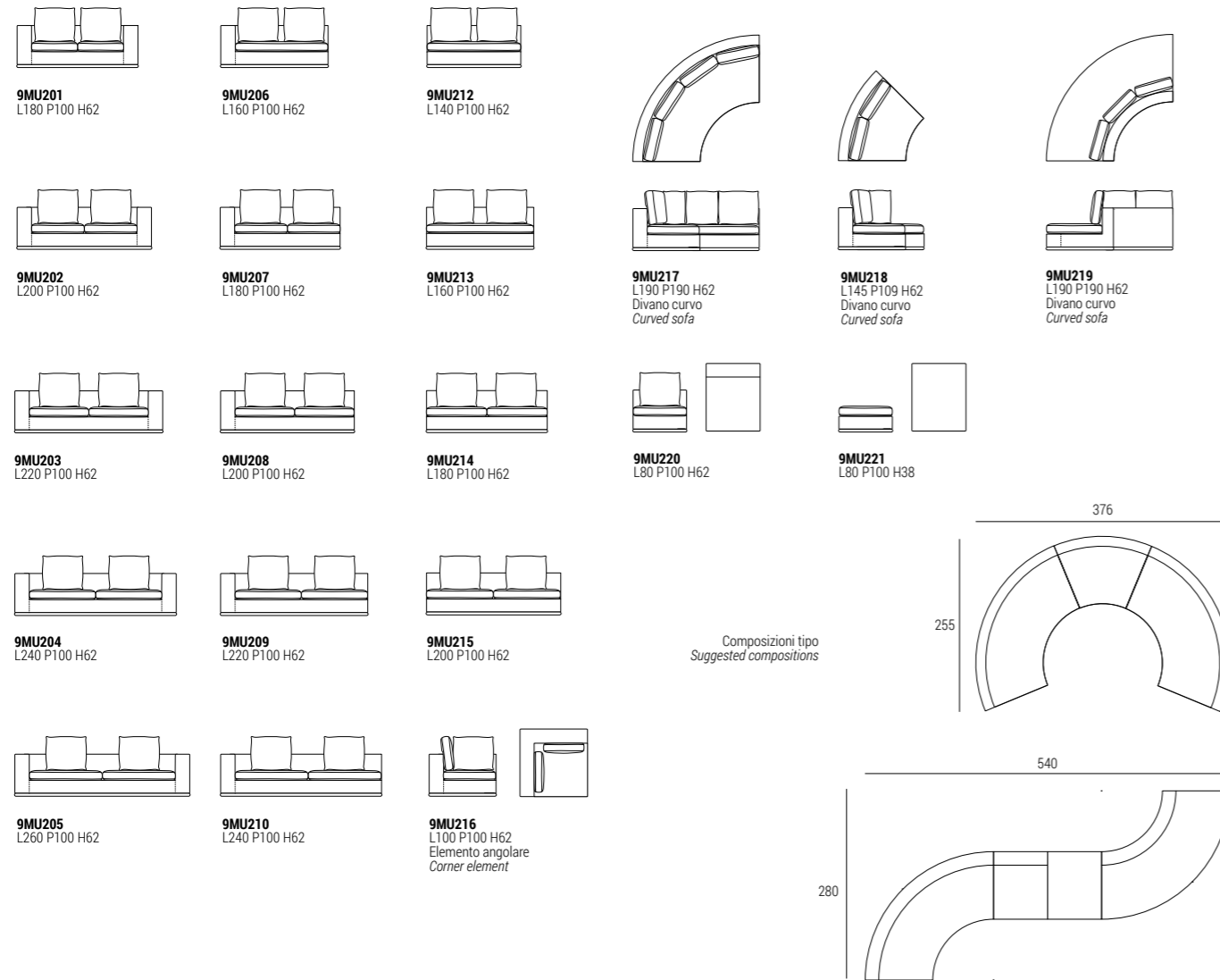

Composizioni tipo  
Suggested compositions

Dormeuse  
Longchair

Pouf e accessori  
Ottomans and accessories

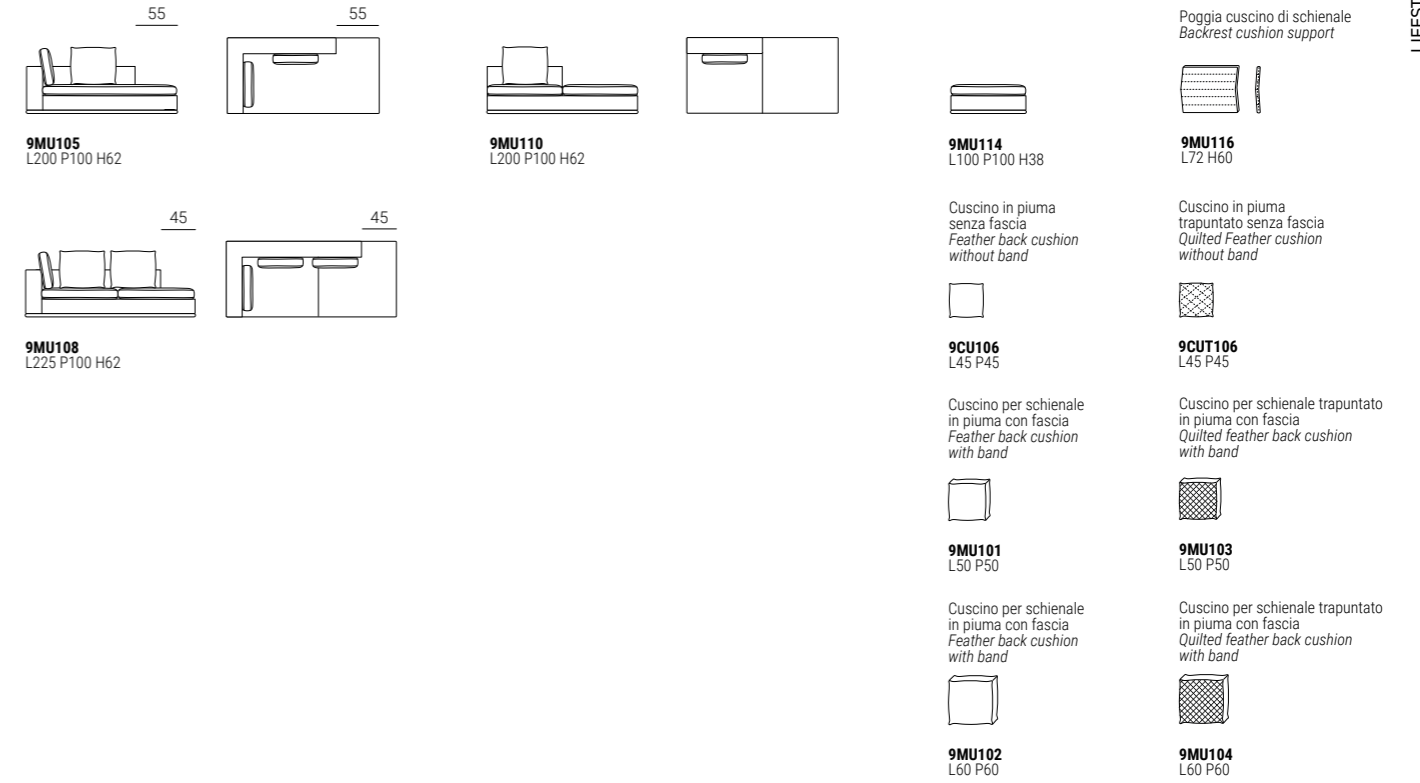

Finiture base metallo  
Metal base finishes

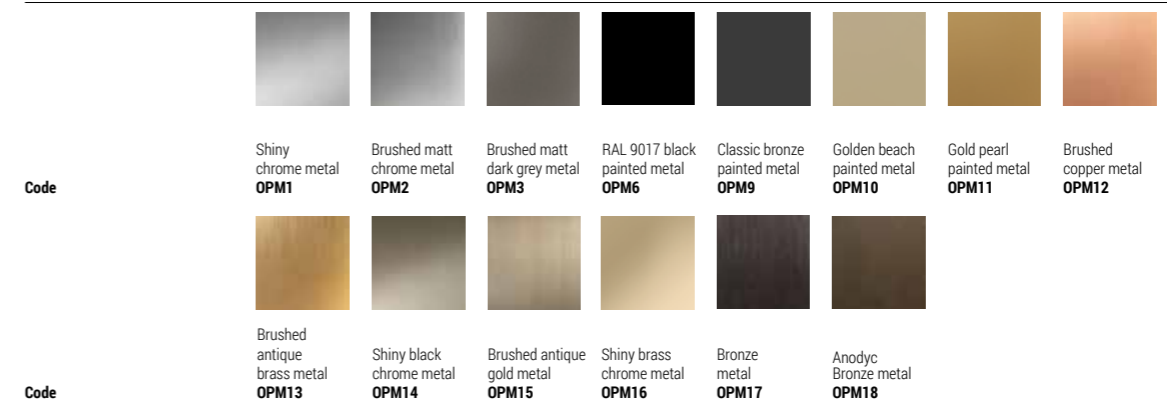

# Megan

DESIGN  
STUDIO MARELLI  
2019

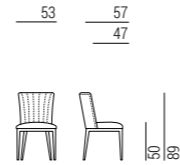

LIFESTYLE COLLECTION 2021 \_ MARELLI

Schienale in legno multistrato di pioppo curvato imbottito con poliuretano espanso con densità 30 kg/m<sup>3</sup>. Seduta in legno multistrato di pioppo imbottito con poliuretano espanso 40 kg/m<sup>3</sup>, rivestito in dacron con cinghie elastiche intrecciate. Rivestimento fisso. Basamento in rovere nelle finiture standard. La versione standard è dotata di antiscivolanti in PVC. Disponibili a richiesta altri tipi di antiscivolanti, in feltro e plastica.

*Dossier en bois multiplis de peuplier courbé fini de mousse de polyuréthane de densité de 30 kg/m<sup>3</sup>. Structure de l'assise en bois multiplis de peuplier finie de mousse de polyuréthane de densité de 40 kg/m<sup>3</sup> couverte de dacron, muni de bandes élastiques entrecroisées. Revêtement fixe. Piètement en chêne dans les finitions standard. Equipé de patins en PVC dans la version standard. Disponible sur demande avec d'autres patins, en feutre ou en plastique.*

*Backrest made of curved multi-ply poplar wood, upholstered with polyurethane foam with density 30 kg/m<sup>3</sup>. Seat structure made of multi-ply poplar wood, upholstered with polyurethane foam with density of 40 kg/m<sup>3</sup>, covered with dacron, with interwoven elastic belts. Fixed covers. Oak base in the standard finishes. The standard version is equipped with PVC glides. Other kinds of glides in plastic or felt pads are available on demand.*

*Для изготовления спинки используется гнутая многослойная фанера из тополя с наполнением из вспененного полиуретана плотностью 30 кг/м<sup>3</sup>. Конструкция сиденья: многослойная фанера из тополя с наполнением из вспененного полиуретана плотностью 40 кг/м<sup>3</sup>, обернутого в дакрон, в сочетании с перекрещивающимися эластичными ремнями.*

*Rückenlehne aus gebogenem Pappelschichtholz, gepolstert mit Polyurethan-Schaumstoff mit Dichte 30 Kg/m<sup>3</sup>. Sitzstruktur aus Pappelschichtholz, gepolstert mit Polyurethan-Schaumstoff mit Dichte 40 Kg/m<sup>3</sup>, mit Dacron ummantelt, mit geflochtenen Gummigurten. Megan ist immer festbezogen. Fussgestell in Eiche in den Standard-Ausführungen. Standard mit PVC-Gleitern ausgestattet. Andere Gleiter, wie Felz- oder Kunststoffgleiter, sind auf Anfrage verfügbar.*

*Основание стула выполнено из дуба в стандартных цветах. В стандартный комплект по умолчанию входят противоскользящие накладки из ПВХ. По запросу возможно их изготовление из войлока или пластика.*

Poltrona  
Armchair



**9ME101**  
Poltrona trapuntata  
Quilted armchair  
L53 P57 H89

Finiture  
Finishes

Base in legno  
Wooden base



<b>Code</b>	Cherry stained oak <b>OPR1</b>	Wengé stained oak <b>OPR2</b>	Walnut stained oak <b>OPR3</b>	Natural oak <b>OPR4</b>	Black stained oak <b>OPR5</b>	Cherry Milano stained oak <b>OPR6</b>
-------------	-----------------------------------	----------------------------------	-----------------------------------	----------------------------	----------------------------------	--



<b>Code</b>	Tobacco stained oak <b>OPR8</b>	Grey taupe stained oak <b>OPR9</b>	Whitened oak <b>OPR10</b>	Charcoal stained oak <b>OPR11</b>	Mahogany stained oak <b>OPR12</b>	Moka matt stained oak <b>OPR15</b>
-------------	------------------------------------	---------------------------------------	------------------------------	--------------------------------------	--------------------------------------	---------------------------------------

# Mini

DESIGN  
STUDIO MARELLI  
2009

407

LIFESTYLE COLLECTION 2021 \_ MARELLI

Tavoli  
Tables



Server in metallo, spessore 5 mm  
Server table in metal, 5 mm thick



Finiture  
Finishes

Struttura in metallo  
Metal structure

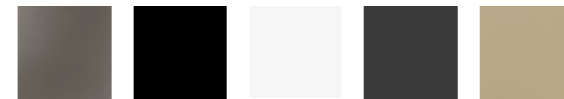

<b>Code</b>	Brushed matt dark grey metal <b>OPM3</b>	RAL 9017 black painted metal <b>OPM6</b>	RAL 9016 white painted metal <b>OPM7</b>	Classic bronze painted metal <b>OPM9</b>	Golden beach painted metal <b>OPM10</b>
-------------	---	---	---	---	--



<b>Code</b>	Gold pearl painted metal <b>OPM11</b>	Brushed copper metal <b>OPM12</b>	Brushed antique brass metal <b>OPM13</b>	Brushed antique gold metal <b>OPM15</b>	Anodyc Bronze metal <b>OPM18</b>
-------------	--	--------------------------------------	---	--	-------------------------------------

Fusto in legno massello e legno multistrato con cinghie elastiche intrecciate.  
Imbottitura della seduta in poliuretano espanso con densità 40 kg/m<sup>3</sup> rivestito in dacron.  
Imbottitura dello schienale in poliuretano espanso a quote differenziate con densità di 30 kg/m<sup>3</sup> e 40 kg/m<sup>3</sup>, rivestito in dacron.  
Rivestimento fisso.

*Carcasse en bois massif et multiplis munie de bandes élastiques entrecroisées.  
Assise rembourrée en mousse de polyuréthane d'une densité de 40 kg/m<sup>3</sup> couverte de dacron.  
Dossier rembourré en mousse polyuréthane de différentes densités de 30 kg/m<sup>3</sup> et 40 kg/m<sup>3</sup> couverte de dacron.  
Revêtement fixe.*

Frame made of solid wood and plywood with interwoven elastic belts.  
Seat upholstered with polyurethane foam with density of 40 kg/m<sup>3</sup>, covered with dacron.  
Back upholstered with polyurethane foam with different densities of 30 kg/m<sup>3</sup> and 40 kg/m<sup>3</sup>, covered with dacron.  
Fixed covers.

*Для производства каркаса используется массив дерева и многослойная фанера в сочетании с перекрещивающимися эластичными ремнями. Наполнение сиденья из вспененного пенополиуретан плотностью - 30 кг/м<sup>3</sup>, обернутого в дакрон.  
Наполнение спинки из вспененного пенополиуретана различной степени плотности - 30 кг/м<sup>3</sup> и 40 кг/м<sup>3</sup>, обернутого в дакрон.  
Чехлы несъемные.*

Das Gestell besteht aus Massiv- und Schichtholz, mit geflochtenen Gummigurten.  
Sitz gepolstert mit Polyurethan-Schaumstoff 40 Kg/m<sup>3</sup>, mit Dacron bezogen.  
Rücken gepolstert mit Polyurethan-Schaumstoff in verschiedenen Dichten 30 Kg/m<sup>3</sup> und 40 Kg/m<sup>3</sup>, mit Dacron bezogen.  
Ribot ist immer festbezogen.

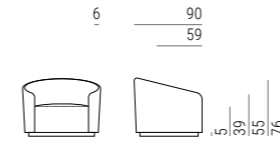

## Divani Sofas



**9MN101**  
L98 P90 H76

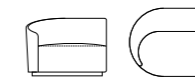

**9MN206**  
L106 P90 H76



**9MN201**  
L200 P90 H76

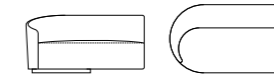

**9MN207**  
L156 P90 H76



**9MN202**  
L250 P90 H76

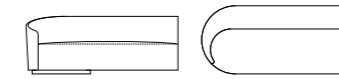

**9MN208**  
L201 P90 H76



**9MN203**  
L245 P120 H76

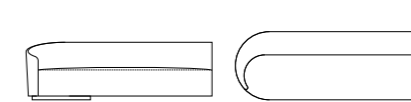

**9MN209**  
L246 P90 H76



**9MN204**  
L305 P120 H76

## Pouf e accessori Ottomans and accessories

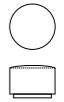

**9MN102**  
Ø60 H40



**9CU106**  
L45 P45

Cuscino in piuma senza fascia  
Feather back cushion without band

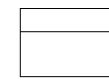

**9MN210**  
L130 P90 H76

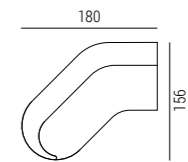

**9MN205**  
L180 P156 H76

## Finiture Finishes

Base metallo  
Metal base



Shiny chrome metal **OPM1** | Brushed matt chrome metal **OPM2** | Brushed matt dark grey metal **OPM3** | RAL 9017 black painted metal **OPM6** | RAL 9016 white painted metal **OPM7** | Classic bronze painted metal **OPM9**



Golden beach painted metal **OPM10** | Gold pearl painted metal **OPM11** | Brushed antique copper metal **OPM12** | Brushed antique brass metal **OPM13** | Shiny black chrome metal **OPM14** | Brushed antique gold metal **OPM15** | Shiny brass chrome metal **OPM16** | Bronze metal **OPM17** | Anodyc Bronze metal **OPM18**

Schienale in legno multistrato di pioppo curvato imbottito con poliuretano espanso con densità 30 kg/m<sup>3</sup>. Seduta in legno multistrato di pioppo imbottito con poliuretano espanso con densità 40 kg/m<sup>3</sup>, rivestito in dacron con cinghie elastiche intrecciate. Rivestimento fisso.

*Dossier en bois multiplis de peuplier courbé fini de mousse de polyuréthane de densité de 30 kg/m<sup>3</sup>. Structure d'assise en bois multiplis de peuplier finie de mousse de polyuréthane de densité de 40 kg/m<sup>3</sup> couverte de dacron, muni de bandes élastiques entrecroisées. Le revêtement est toujours fixe.*

Backrest made of curved multi-ply poplar wood, upholstered with polyurethane foam with density 30 kg/m<sup>3</sup>. Seat structure made of multi-ply poplar wood, upholstered with polyurethane foam with density 40 kg/m<sup>3</sup>, covered with dacron, with interwoven elastic belts. Fixed covers.

*Спинка: гнутая многослойная фанера из тополя в сочетании со вспененным полиуретаном плотностью 30кг/м<sup>3</sup>. Сиденье: гнутая многослойная фанера из тополя в сочетании со вспененным полиуретаном плотностью 40кг/м<sup>3</sup>, обернутым в дакрон. Подвеска из перекрещивающихся эластичных ремней. Обивка съёмная.*

Rückenlehne aus gebogenem Pappelschichtholz, gepolstert mit Polyurethan-Schaumstoff mit Dichte 30 Kg/m<sup>3</sup>. Sitzstruktur aus Pappelschichtholz, gepolstert mit Polyurethan-Schaumstoff mit Dichte 40 Kg/m<sup>3</sup>, mit Dacron Ummantelt, mit gefrochtenen Gummigurten. Clipper ist immer festbezogen.

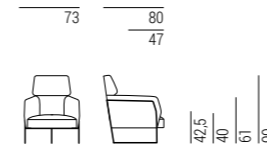

Divani  
Sofas



**9NE101**  
L73 P80 H90



**9NE201**  
L150 P80 H90

## Finiture Finishes

Base metallo  
Metal base



Code  
Shiny chrome metal **OPM1**  
Brushed matt chrome metal **OPM2**  
Brushed matt dark grey metal **OPM3**  
RAL 9017 black painted metal **OPM6**  
RAL 9016 white painted metal **OPM7**  
Classic bronze painted metal **OPM9**



Code  
Golden beach painted metal **OPM10**  
Gold pearl painted metal **OPM11**  
Brushed copper metal **OPM12**  
Brushed antique brass metal **OPM13**  
Shiny black chrome metal **OPM14**  
Brushed antique gold metal **OPM15**  
Shiny brass chrome metal **OPM16**  
Bronze metal **OPM17**  
Anodized Bronze metal **OPM18**

Schienale in legno multistrato di pioppo curvato imbottito con poliuretano espanso con densità 30 kg/m<sup>3</sup>. Seduta in legno multistrato di pioppo imbottito con poliuretano espanso 40 kg/m<sup>3</sup>, rivestito in dacron con cinghie elastiche intrecciate. Disponibile con trapuntatura sulla parte interna dello schienale oppure liscia. Rivestimento fisso. Basamento in rovere nelle finiture standard o rivestito in tessuto o pelle. La versione standard è dotata di antiscivolanti in PVC. Disponibili a richiesta altri tipi di antiscivolanti, in feltro e plastica.

*Dossier en bois multiplis de peuplier courbé fini de mousse de polyuréthane de densité de 30 kg/m<sup>3</sup>. Structure de l'assise en bois multiplis de peuplier finie de mousse de polyuréthane de densité de 40 kg/m<sup>3</sup> couverte de dacron, muni de bandes élastiques entrecroisées. Disponible avec ou sans côté intérieur matelassé. Revêtement fixe. Piètement en chêne dans les finitions standard ou recouvert de tissu ou cuir. Equipé de patins en PVC dans la version standard. Disponible sur demande avec d'autres patins, en feutre ou en plastique.*

*Backrest made of curved multi-ply poplar wood, upholstered with polyurethane foam with density 30 kg/m<sup>3</sup>. Seat structure made of multi-ply poplar wood, upholstered with polyurethane foam with density of 40 Kg/m<sup>3</sup>, covered with dacron, with interwoven elastic belts. Available with or without quilted inner side. Fixed covers. Oak base in the standard finishes or covered with fabric or leather. The standard version is equipped with PVC glides. Other kinds of glides in plastic or felt pads are available on demand.*

*Для изготовления спинки используется гнутая многослойная фанера из тополя с наполнением из вспененного полиуретана плотностью 30 кг/м<sup>3</sup>. Конструкция сиденья: многослойная фанера из тополя с наполнением из вспененного полиуретана плотностью 40 кг/м<sup>3</sup>, обернутого в дакрон, в сочетании с перекрещивающимися эластичными ремнями. Для внутренней части спинки предусмотрено 2 варианта отделки: гладкая, либо с декоративной простежкой. Обивка несъемная.*

*Rückenlehne aus gebogenem Pappelschichtholz, gepolstert mit Polyurethan-Schaumstoff mit Dichte 30 Kg/m<sup>3</sup>. Sitzstruktur aus Pappelschichtholz, gepolstert mit Polyurethan-Schaumstoff mit Dichte 40 Kg/m<sup>3</sup>, mit Dacron ummantelt, mit geflochtenen Gummigurten. Verfügbar mit oder ohne abgesteppte Innenseite. Paris ist immer festbezogen. Eichengestell in den Standard-Ausführungen oder mit Stoff oder Leder bezogen. Standard mit PVC-Gleitern ausgestattet. Andere Gleiter, wie Felz- oder Kunststoffgleiter, sind auf Anfrage verfügbar.*

*Основание стула выполнено из дуба в стандартных цветах, либо в коже или ткани. В стандартный комплект по умолчанию входят противоскользящие накладки из ПВХ. По запросу возможно их изготовление из войлока или пластика.*

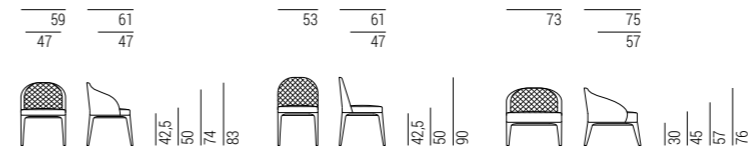

## Divani Sofas



Il modello Paris è disponibile a richiesta con trapuntatura anche sulla parte esterna dello schienale.  
*On demand Paris is available also with quilting on the external side of the backrest.*

## Finiture Finishes

Base standard  
Standard base



Code  
Cherry stained oak **OPR1** | Wengé stained oak **OPR2** | Walnut stained oak **OPR3** | Natural oak **OPR4** | Black stained oak **OPR5** | Cherry Milano stained oak **OPR6**



Code  
Tobacco stained oak **OPR8** | Grey taupe stained oak **OPR9** | Whitened oak **OPR10** | Charcoal stained oak **OPR11** | Mahogany stained oak **OPR12** | Moka matt stained oak **OPR15**

Base optional  
Optional base

Base in rovere rivestita in tessuto / pelle  
*Oak base covered in fabric / leather*

## Cuciture opzionali Optional stitchings

Punto Cavallo Stitching





# Self Dining Table

DESIGN  
STUDIO MARELLI  
2014

414

LIFESTYLE COLLECTION 2021 \_ MARELLI

Tavoli  
Tables



**7SEL101**  
L200 P100 H74

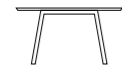
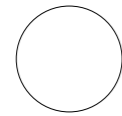

**7SEL102**  
ø140 H74

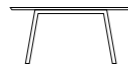

**7SEL103**  
L160 P160 H74

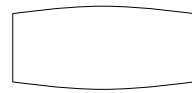

**7SEL104**  
L240 P110 H74

# Self Dining Table

DESIGN  
STUDIO MARELLI  
2014

415

LIFESTYLE COLLECTION 2021 \_ MARELLI

Finiture  
Finishes

Top in marmo  
Marble top

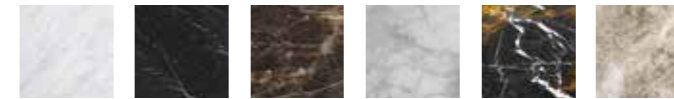

**Code**  
White Carrara marble **OPP1**    Black Marquina marble **OPP2**    Brown Emperador marble **OPP3**    Calacatta gold marble **OPP7**    Black and gold marble **OPP9**    Peretto brown marble **OPP10**



**Code**  
Grey Stone marble **OPP11**    Guatemala green marble **OPP12**    Velvet brown marble **OPP13**    Amani Bronze marble **OPP14**    Covelano white marble **OPP15**    Sahara noir marble **OPP16**    Port Laurent marble **OPP17**    Arabescato orobico grey marble **OPP20**    Calacatta violet marble **OPP21**

Top in Gres Porcellanato  
Porcelain Stoneware Top



**Code**  
Nero Marquina **OPG2**    Statuario Select **OPG3**    Calacatta Royal **OPG4**    Bianco Dolomite **OPG5**

Base in metallo  
Metal base



**Code**  
Shiny chrome metal **OPM1**    Brushed matt chrome metal **OPM2**    Brushed matt dark grey metal **OPM3**    Classic bronze painted metal **OPM9**    Golden beach painted metal **OPM10**    Gold pearl painted metal **OPM11**



**Code**  
Brushed copper metal **OPM12**    Brushed antique brass metal **OPM13**    Shiny black chrome metal **OPM14**    Brushed antique gold metal **OPM15**    Shiny brass chrome metal **OPM16**    Bronze metal **OPM17**    Anodized Bronze metal **OPM18**

Schienale in legno multistrato di pioppo curvato imbottito con poliuretano espanso con densità 30 kg/m<sup>3</sup>. Seduta in legno multistrato di pioppo imbottito con poliuretano espanso 40 kg/m<sup>3</sup>, rivestito in dacron con cinghie elastiche intrecciate. Rivestimento fisso.

*Dossier en bois multiplis de peuplier courbé fini de mousse de polyuréthane de densité de 30 kg/m<sup>3</sup>. Structure de l'assise en bois multiplis de peuplier finie de mousse de polyuréthane de densité de 40 kg/m<sup>3</sup> couverte de dacron, muni de bandes élastiques entrecroisées. Revêtement fixe.*

Backrest made of curved multi-ply poplar wood, upholstered with polyurethane foam with density 30 kg/m<sup>3</sup>. Seat structure made of multi-ply poplar wood, upholstered with polyurethane foam with density of 40 Kg/m<sup>3</sup>, covered with dacron, with interwoven elastic belts. Fixed covers.

*Для изготовления спинки используется гнутая многослойная фанера из тополя с наполнением из вспененного полиуретана плотностью 30 кг/м<sup>3</sup>. Конструкция сиденья: многослойная фанера из тополя с наполнением из вспененного полиуретана плотностью 40 кг/м<sup>3</sup>, обернутого в дакрон, в сочетании с перекрещивающимися эластичными ремнями. Обивка несъемная.*

Rückenlehne aus aus gebogenem Pappelschichtholz, gepolstert mit Polyurethan-Schaumstoff mit Dichte 30 Kg/m<sup>3</sup>. Sitzstruktur aus Pappelschichtholz, gepolstert mit Polyurethan-Schaumstoff mit Dichte 40 Kg/m<sup>3</sup>, mit Dacron ummantelt, mit geflochtenen Gummigurten. Sign ist immer festbezogen.

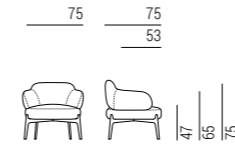

## Divani Sofas



**9SI101**  
Poltrona girevole/Swivel armchair  
L83 P75 H75



**9SI112**  
Base in metallo/Metal base  
L83 P75 H75

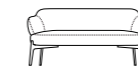

**9SI211**  
Base in metallo/Metal base  
L160 P75 H75

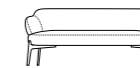

**9SI212**  
Base in metallo/Metal base  
L180 P75 H75



**9SI102**  
Base in legno/Wood base  
L83 P75 H75

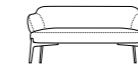

**9SI201**  
Base in legno/Wood base  
L160 P75 H75

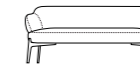

**9SI202**  
Base in legno/Wood base  
L180 P75 H75

## Finiture Finishes

Base in metallo  
+ base in metallo girevole  
Metal base  
+ swivel metal base



**Code** Shiny chrome metal **OPM1** Brushed matt chrome metal **OPM2** Brushed matt dark grey metal **OPM3** RAL 9017 black painted metal **OPM6** RAL 9016 white painted metal **OPM7** Classic bronze painted metal **OPM9** Golden beach painted metal **OPM10** Gold pearl painted metal **OPM11**



**Code** Brushed copper metal **OPM12** Brushed antique brass metal **OPM13** Shiny black chrome metal **OPM14** Brushed antique gold metal **OPM15** Shiny brass chrome metal **OPM16** Bronze metal **OPM17** Anodyc Bronze painted metal **OPM18**

Base in legno  
Wooden base



**Code** Cherry stained oak **OPR1** Wengé stained oak **OPR2** Walnut stained oak **OPR3** Natural oak **OPR4** Black stained oak **OPR5** Cherry Milano stained oak **OPR6**



**Code** Tobacco stained oak **OPR8** Grey taupe stained oak **OPR9** Whitened oak **OPR10** Charcoal stained oak **OPR11** Mahogany stained oak **OPR12** Moka matt stained oak **OPR15**

Fusto in legno massello e legno multistrato con cinghie elastiche intrecciate. Imbottitura in espanso rivestito in vellutino bianco. Cuscini di schienale in Piumafib, una speciale miscela ipoallergenica di vera piuma e fibra poliestere siliconata\*. Cuscini di seduta in poliuretano espanso con densità di 30 Kg/m<sup>3</sup> (su richiesta è possibile avere densità 40 Kg/m<sup>3</sup> medio o 40 Kg/m<sup>3</sup> morbido), rivestito in fibre termo legate e in tessuto di puro cotone. Completamente sfoderabile in tessuto, non sfoderabile in pelle e finta pelle.  
\*Manutenzione dei cuscini contenenti piuma: I cuscini contenenti piuma tendono a deformarsi con l'utilizzo. Per mantenerne la forma è necessario, anche dopo un breve utilizzo, battere e sprimacciare ripetutamente i cuscini. Non utilizzare mai battipanni o aspirapolvere. A coloro che non desiderassero seguire queste indicazioni o che volessero un divano dall'aspetto meno vissuto, raccomandiamo di preferire dei cuscini in gomma.

Carcasse en bois massif et multiplis muni de bandes élastiques entrecroisées et finie de mousse polyuréthane couverte de dacron. Coussins de dossier en Piumafib, un mélange hypoallergénique spécial de véritable duvet et fibre polyester siliconisée\*. Coussins d'assise en mousse polyuréthane d'une densité de 30 kg/m<sup>3</sup> (sur demande, il est possible d'avoir une densité de 40 kg/m<sup>3</sup> medium ou 40 kg/m<sup>3</sup> souple), couverte de dacron. Revêtement complètement déhoussable en tissu, fixe en cuir et cuir look.  
\* Entretien de coussins en duvet: Coussins en duvet ont tendance à perdre leur forme dû à l'usage. Pour en conserver la forme il est nécessaire, aussi après un usage court, de régulièrement battre les coussins. Ne jamais utiliser la tapette ou l'aspirateur. À ceux qui ne désirent pas suivre ces indications ou qui souhaitent un canapé qui ait l'air moins "usé", nous conseillons vivement de choisir des coussins en mousse polyuréthane.

Frame made of solid wood and multi-ply wood with interwoven elastic straps, upholstered with polyurethane foam, covered with dacron. The back cushions are filled with Piumafib, a special hypoallergenic mixture of feathers and siliconised polyfibre\*. The seat cushions are made of polyurethane foam with density of 30 Kg/m<sup>3</sup> (on demand it is possible to have 40 Kg/m<sup>3</sup> medium or 40 Kg/m<sup>3</sup> soft), covered with dacron and pure cotton fabric. Fully removable fabric covers, fixed leather and artificial leather covers.  
\*Maintenance of feather cushions: Cushions filled with feathers tend to change their shape with use. In order to keep their shape it is necessary, even after a short use, to plump up the cushions repeatedly. Never use carpet beater or vacuum cleaner. We recommend to choose foam cushions to those who do not wish to follow these instructions or to have a "used look" sofa.

Для производства каркаса используется массив дерева и многослойная фанера в сочетании с перекрещивающимися эластичными ремнями. Наполнение из полиуретана, обернутого в белый бархат. Наполнение подушек спинки выполнено из материала Piumafib – специальной, не вызывающей аллергии смеси из натурального пуха и полиэфирных силиконовых волокон\*. Наполнение подушек сиденья: пенополиуретан плотностью 30 кг/м<sup>3</sup> (по запросу - 40 кг/м<sup>3</sup> средней мягкости или мягкий), покрытый термосвязанным волокном и обернутый в ткань из натурального хлопка. Полностью съемные чехлы из ткани, несъемные чехлы из кожи (искусственной или натуральной)

Das Gestell besteht aus Massiv- und Schichtholz, mit geflochtenen Gummigurten, gepolstert mit Polyurethanschaumstoff, mit Dacron bezogen. Rueckenkissen aus Piumafib, einer hypoallergischen speziellen Mischung aus echter Daune und silikonisierter Polyesterfaser\*. Die Sitzkissen bestehen aus Polyurethan-Schaumstoff 30 Kg/m<sup>3</sup> (auf Anfrage kann man 40 Kg/m<sup>3</sup> medium oder 40 Kg/m<sup>3</sup> weich haben), bezogen mit Dacron und reinem Baumwollstoff. Stoffbezüge alle abziehbar, Leder und Kunstleder festbezogen.  
\*Wartungsanleitungen fuer Daunenkissen: Die Kissen, die Daunen enthalten, neigen dazu, sich durch Gebrauch zu verformen. Um die urspruengliche Form zu halten, ist es notwendig, auch nach kurzem Gebrauch, die Kissen wiederholt aufzuschuettern. Keinen Ausklopfen oder Staubsauger verwenden. Unseren Kunden, die diese Anweisungen nicht befolgen moechten, oder die kein Sofa mit solchem "gebrauchten" Aussehen haben moechten, empfehlen wir Polyurethan-Kissen.

\*Эксплуатация подушек с пуховым наполнением: В процессе эксплуатации подушки с пуховым наполнением могут деформироваться, во избежание чего их необходимо слегка взбивать вручную даже после непродолжительного нахождения на диване. Использование в этих целях пылесоса или выбивалки для одежды категорически запрещено. Если клиент не планирует следовать данным инструкциям и хочет, чтобы подушки сиденья и спинки проминались по минимуму, посоветуйте выбрать наполнение только из полиуретана, полностью исключив натуральный пух.

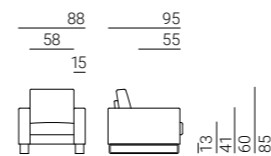
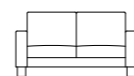
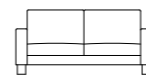
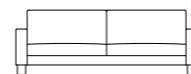
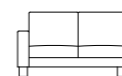
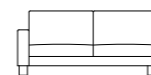
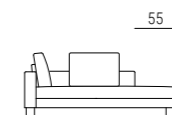
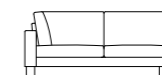
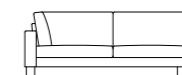
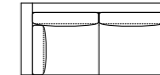
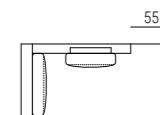
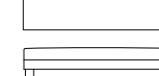
Divani  
Sofas**9SL101**  
L88 P95 H85**9SL202**  
L160 P95 H85**9SL203**  
L180 P95 H85**9SL304**  
L200 P95 H85**9SL305**  
L220 P95 H85**9SL306**  
L240 P95 H85**9SL209**  
L145 P95 H85**9SL210**  
L165 P95 H85**9SL311**  
L185 P95 H85**9SL312**  
L205 P95 H85Elementi componibili  
Modular elements**9SL315**  
L195 P95 H85**9SL113**  
L95 P95 H85  
Elemento angolare  
Corner element**9SL116**  
L95 P95 H85Dormeuse  
Longchair**9SL205**  
L200 P95 H85**9SL206**  
L225 P95 H85**9SL107**  
L191 P95 H85**9SL208**  
L215 P95 H85Pouf  
Pouf**9SL106**  
L95 P95 H41**9SL112**  
L195 P95 H41

# Slide Quilted

DESIGN  
STUDIO MARELLI  
1999

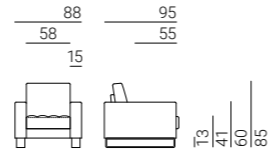

420

LIFESTYLE COLLECTION 2021 \_ MARELLI

## Divani Sofas



**9SLT101**  
L88 P95 H85

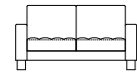

**9SLT202**  
L160 P95 H85

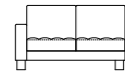

**9SLT209**  
L145 P95 H85



**9SLT203**  
L180 P95 H85

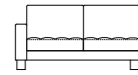

**9SLT210**  
L165 P95 H85



**9SLT304**  
L200 P95 H85



**9SLT311**  
L185 P95 H85



**9SLT305**  
L220 P95 H85



**9SLT312**  
L205 P95 H85

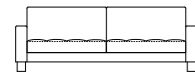

**9SLT306**  
L240 P95 H85

## Elementi componibili Modular elements



**9SLT315**  
L195 P95 H85



**9SLT113**  
L95 P95 H85  
Elemento angolare  
Corner element



**9SLT116**  
L95 P95 H85

## Dormeuse Longchair

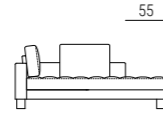

**9SLT205**  
L200 P95 H85

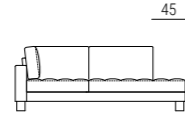

**9SLT206**  
L225 P95 H85

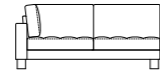

**9SLT107**  
L191 P95 H85

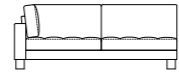

**9SLT208**  
L215 P95 H85

## Pouf Pouf

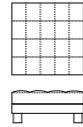

**9SL106**  
L95 P95 H41

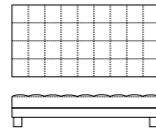

**9SL112**  
L195 P95 H41

## Accessori Accessories



**9VR102**  
L45 H45  
Cuscinetto in piuma con fascia  
Feather cushion with band



**9CU103**  
L40 H40  
Cuscinetto in piuma senza fascia  
Feather cushion without band

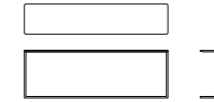

**9VR114**  
L190 P40 H63

## Piedini Feet

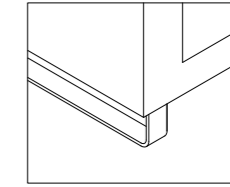

**Versione A (standard)**  
Basamento in metallo  
**Version A (standard)**  
Metal base

H 13 cm

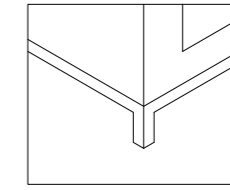

**Versione B**  
Basamento in legno  
**Version B**  
Wooden base

H 13 cm

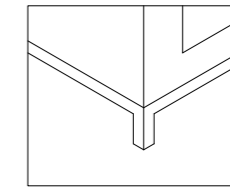

**Versione C**  
Basamento in metallo  
**Version C**  
Metal base

H 13 cm

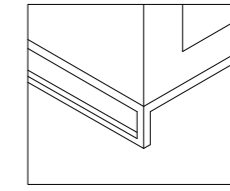

**Versione D**  
Basamento in metallo  
**Version D**  
Metal base

H 13 cm

# Slide

DESIGN  
STUDIO MARELLI  
1999

421

LIFESTYLE COLLECTION 2021 \_ MARELLI

## Finiture piedini Feet finishes

Versione A-C-D  
+ base console 9VR114  
Version A-C-D  
+ 9VR114 console base

<b>Code</b>	<b>Shiny chrome metal OPM1</b>	<b>Brushed matt chrome metal OPM2</b>	<b>Brushed matt dark grey metal OPM3</b>	<b>RAL 9017 black painted metal OPM6</b>	<b>RAL 9016 white painted metal OPM7</b>	<b>Classic bronze painted metal OPM9</b>	<b>Golden beach painted metal OPM10</b>	<b>Gold pearl painted metal OPM11</b>	<b>Brushed copper metal OPM12</b>	
<b>Code</b>	<b>Brushed antique brass metal OPM13</b>	<b>Shiny black chrome metal OPM14</b>	<b>Brushed antique gold metal OPM15</b>	<b>Shiny brass chrome metal OPM16</b>	<b>Bronze metal OPM17</b>	<b>Anodyc Bronze metal OPM18</b>				

Versione B  
Version B

<b>Code</b>	<b>Cherry stained beech OPF1</b>	<b>Wengé stained beech OPF2</b>	<b>Walnut stained beech OPF3</b>	<b>Natural beech OPF4</b>	<b>Black stained beech OPF5</b>	<b>Cherry Milano stained beech OPF6</b>	<b>Tobacco stained beech OPF8</b>	<b>Grey taupe stained beech OPF9</b>	<b>Charcoal stained beech OPF11</b>	<b>Mahogany stained beech OPF12</b>

## Finiture top consolle Console table top finishes

<b>Code</b>	<b>Cherry stained oak OPR1</b>	<b>Wengé stained oak OPR2</b>	<b>Walnut stained oak OPR3</b>	<b>Natural oak OPR4</b>	<b>Black stained oak OPR5</b>	<b>Cherry Milano stained oak OPR6</b>	<b>Tobacco stained oak OPR8</b>	<b>Grey taupe stained oak OPR9</b>	<b>Whitened oak OPR10</b>	
<b>Code</b>	<b>Charcoal stained oak OPR11</b>	<b>Mahogany stained oak OPR12</b>	<b>Moka matt stained oak OPR15</b>							

## Tavoli Tables

<b>7TAB101</b> Piano superiore in marmo Piano inferiore in legno Marble upper top Wooden lower top	<b>7TAB102</b> Piano superiore in marmo Piano inferiore in legno Marble upper top Wooden lower top	<b>7TAB103</b> Piano superiore in marmo Piano inferiore in legno Marble upper top Wooden lower top	<b>7TAB104</b> Piano superiore in marmo Piano inferiore in legno Marble upper top Wooden lower top	<b>7TAB105</b> Piano superiore in marmo Piano inferiore in legno Marble upper top Wooden lower top	<b>7TAB106</b> Piano superiore in marmo Piano inferiore in legno Marble upper top Wooden lower top	<b>7TAB107</b> Piano superiore in marmo Piano inferiore in legno Marble upper top Wooden lower top	<b>7TAB108</b> Piano superiore in marmo Piano inferiore in legno Marble upper top Wooden lower top
<b>7TAB111</b> Piano superiore in marmo Piano inferiore in vetro Marble upper top Glass lower top	<b>7TAB112</b> Piano superiore in marmo Piano inferiore in vetro Marble upper top Glass lower top	<b>7TAB113</b> Piano superiore in marmo Piano inferiore in vetro Marble upper top Glass lower top	<b>7TAB114</b> Piano superiore in marmo Piano inferiore in vetro Marble upper top Glass lower top	<b>7TAB115</b> Piano superiore in marmo Piano inferiore in vetro Marble upper top Glass lower top	<b>7TAB116</b> Piano superiore in marmo Piano inferiore in vetro Marble upper top Glass lower top	<b>7TAB117</b> Piano superiore in marmo Piano inferiore in vetro Marble upper top Glass lower top	<b>7TAB118</b> Piano superiore in marmo Piano inferiore in vetro Marble upper top Glass lower top
<b>7TAB121</b> Piano superiore e inferiore in vetro Glass lower and upper top Ø60 H36	<b>7TAB122</b> Piano superiore e inferiore in vetro Glass lower and upper top Ø60 H50	<b>7TAB123</b> Piano superiore e inferiore in vetro Glass lower and upper top Ø90 H36	<b>7TAB124</b> Piano superiore e inferiore in vetro Glass lower and upper top Ø125 H36	<b>7TAB125</b> Piano superiore e inferiore in vetro Glass lower and upper top L65 P65 H36	<b>7TAB126</b> Piano superiore e inferiore in vetro Glass lower and upper top L90 P90 H36	<b>7TAB127</b> Piano superiore e inferiore in vetro Glass lower and upper top L127 P54 H36	<b>7TAB128</b> Piano superiore e inferiore in vetro Glass lower and upper top L120 P70 H36

Piano superiore: marmo, spessore 20 mm  
Piano inferiore: legno impiallacciato  
noce Canaletto o rovere, spessore 20 mm  
Struttura: metallo, sezione 10 mm  
Upper top: marble, 20 mm thick  
Lower top: Canaletto walnut or oak veneer, 20 mm thick  
Structure: metal, section 10 mm

Piano superiore: marmo, spessore 20 mm  
Piano inferiore: vetro temperato extra light, spessore 6 mm  
Struttura: metallo, sezione 10 mm  
Upper top: marble, 20 mm thick  
Lower top: extralight tempered glass, 6 mm thick  
Structure: metal, section 10 mm

Piano superiore: vetro temperato extra light, spessore 6 mm  
Piano inferiore: vetro temperato extra light, spessore 6 mm  
Struttura: metallo, sezione 10 mm  
Upper top: extralight tempered glass, 6 mm thick  
Lower top: extralight tempered glass, 6 mm thick  
Structure: metal, section 10 mm

Finiture  
Finishes

Top in marmo Marble top										
Code	White Carrara marble <b>OPP1</b>	Black Marquina marble <b>OPP2</b>	Brown Emperador marble <b>OPP3</b>	Grey Serena stone <b>OPP4</b>	Beige Brera stone <b>OPP5</b>	Calacatta gold marble <b>OPP7</b>	Black and gold marble <b>OPP9</b>	Perfetto brown marble <b>OPP10</b>	Grey Stone marble <b>OPP11</b>	Guatemala green marble <b>OPP12</b>
Code										
Code	Velvet brown marble <b>OPP13</b>	Amani Bronze marble <b>OPP14</b>	Covelano white marble <b>OPP15</b>	Sahara noir marble <b>OPP16</b>	Port Laurent marble <b>OPP17</b>	Arabescato orobico grey marble <b>OPP20</b>	Calacatta violet marble <b>OPP21</b>			

Top in Gres Porcellanato Porcelain Stoneware Top				
Code	Nero Marquina <b>OPG2</b>	Statuario Select <b>OPG3</b>	Calacatta Royal <b>OPG4</b>	Bianco Dolomite <b>OPG5</b>

Top in vetro Glass top						
Code	RAL 9016 traffic white back-painted glass <b>OPV3</b>	RAL 9017 traffic black back-painted glass <b>OPV4</b>	RAL 7044 silk grey back-painted glass <b>OPV5</b>	RAL 1019 grey beige back-painted glass <b>OPV6</b>	Chrome back-painted bronze glass <b>OPV9</b>	Chrome back-painted grey glass <b>OPV10</b>

Top rovere Oak top						
Code	Cherry stained oak <b>OPR1</b>	Wengé stained oak <b>OPR2</b>	Walnut stained oak <b>OPR3</b>	Natural oak <b>OPR4</b>	Black stained oak <b>OPR5</b>	Cherry Milano stained oak <b>OPR6</b>
Code						
Code	Tobacco stained oak <b>OPR8</b>	Grey taupe stained oak <b>OPR9</b>	Whitened oak <b>OPR10</b>	Charcoal stained oak <b>OPR11</b>	Mahogany stained oak <b>OPR12</b>	Moka matt stained oak <b>OPR15</b>

Struttura in metallo Metal structure						
Code	Shiny chrome metal <b>OPM1</b>	Brushed matt chrome metal <b>OPM2</b>	Brushed matt dark grey metal <b>OPM3</b>	Classic bronze painted metal <b>OPM9</b>	Golden beach painted metal <b>OPM10</b>	Gold pearl painted metal <b>OPM11</b>
Code						
Code	Brushed copper metal <b>OPM12</b>	Brushed antique brass metal <b>OPM13</b>	Shiny black chrome metal <b>OPM14</b>	Brushed antique gold metal <b>OPM15</b>	Shiny brass chrome metal <b>OPM16</b>	Bronze metal <b>OPM17</b>
Code						
Code	Anodized Bronze metal <b>OPM18</b>					

Tavoli  
Tables

<b>7TAT101</b> Top in marmo Marble top <b>7TAT105</b> Top in vetro Glass top Ø40 H51	<b>7TAT102</b> Top in marmo Marble top <b>7TAT106</b> Top in vetro Glass top Ø40 H61	<b>7TAT103</b> Top in marmo Marble top <b>7TAT107</b> Top in vetro Glass top Ø80 H41	<b>7TAT104</b> Top in marmo Marble top <b>7TAT108</b> Top in vetro Glass top Ø100 H41
<p>Top: rovere impiallacciato o marmo, spessore 20 mm Base: tubo di metallo quadrato, sezione 15 mm Top: oak veneer or marble, 20 mm thick Base: square metal tube, section 15 mm</p>			
<p>Top in vetro extralight, temperato, spessore 6 mm Base: tubo di metallo quadrato, sezione 15 mm Top: extralight tempered glass, 6 mm thick Base: square metal tube, section 15 mm</p>			
<b>7TAT128</b> Top in marmo Marble top Ø150 H74	<b>7TAT125</b> Top in marmo Marble top Ø190 H74	<b>7TAT126</b> Top in marmo Marble top <b>7TAT127</b> Top in legno Wooden top L240 P110 H74	<b>7TAT129</b> Top in marmo Marble top <b>7TAT130</b> Top in legno Wooden top L180 P180 H74

Top in marmo Marble top										
Code	White Carrara marble <b>OPP1</b>	Black Marquina marble <b>OPP2</b>	Brown Emperador marble <b>OPP3</b>	Grey Serena stone <b>OPP4</b>	Beige Brera stone <b>OPP5</b>	Calacatta gold marble <b>OPP7</b>	Black and gold marble <b>OPP9</b>	Perfetto brown marble <b>OPP10</b>	Grey Stone marble <b>OPP11</b>	Guatemala green marble <b>OPP12</b>
Code	Velvet brown marble <b>OPP13</b>	Amani Bronze marble <b>OPP14</b>	Covelano white marble <b>OPP15</b>	Sahara noir marble <b>OPP16</b>	Port Laurent marble <b>OPP17</b>	Arabescato orobico grey marble <b>OPP20</b>	Calacatta violet marble <b>OPP21</b>			
Top in Gres Porcellanato Porcelain Stoneware Top										
Code	Nero Marquina <b>OPG2</b>	Statuario Select <b>OPG3</b>	Calacatta Royal <b>OPG4</b>	Bianco Dolomite <b>OPG5</b>						
Top in vetro Glass top										
Code	RAL 9016 traffic white back-painted glass <b>OPV3</b>	RAL 9017 traffic black back-painted glass <b>OPV4</b>	RAL 7044 silk grey back-painted glass <b>OPV5</b>	RAL 1019 grey beige back-painted glass <b>OPV6</b>	Chrome back-painted bronze glass <b>OPV9</b>	Chrome back-painted grey glass <b>OPV10</b>	Transparent grey glass <b>OPV12</b>	Transparent bronze glass <b>OPV13</b>		
Base in metallo Metal base										
Code	Shiny chrome metal <b>OPM1</b>	Brushed matt chrome metal <b>OPM2</b>	Brushed matt dark grey metal <b>OPM3</b>	Classic bronze painted metal <b>OPM9</b>	Golden beach painted metal <b>OPM10</b>	Gold pearl painted metal <b>OPM11</b>				
Code	Brushed copper metal <b>OPM12</b>	Brushed antique brass metal <b>OPM13</b>	Shiny black chrome metal <b>OPM14</b>	Brushed antique gold metal <b>OPM15</b>	Shiny brass chrome metal <b>OPM16</b>	Bronze metal <b>OPM17</b>	Anodyc Bronze metal <b>OPM18</b>			

## Tavoli Tables

<b>7TH101</b> Tavolo in marmo Marble table L80 P80 H19	<b>7TH102</b> Tavolo in marmo Marble table L100 P100 H19	<b>7TH111</b> Tavolo in marmo con base metallo Marble table with metal base L80 P80 H27	<b>7TH112</b> Tavolo in marmo con base metallo Marble table with metal base L100 P100 H27							
<b>7TH103</b> Tavolo in marmo Marble table L40 P40 H40	<b>7TH104</b> Tavolo in marmo Marble table L50 P50 H50	<b>7TH105</b> Tavolo in marmo Marble table L60 P60 H19	<b>7TH115</b> Tavolo in marmo con base metallo Marble table with metal base L60 P60 H27	<b>7TH106</b> Tavolo in marmo Marble table L60 P110 H19	<b>7TH116</b> Tavolo in marmo con base metallo Marble table with metal base L60 P110 H27					
Finiture Finishes										
Marmo Marble										
Code	White Carrara marble <b>OPP1</b>	Black Marquina marble <b>OPP2</b>	Brown Emperador marble <b>OPP3</b>	Grey Serena stone <b>OPP4</b>	Beige Brera stone <b>OPP5</b>	Calacatta gold marble <b>OPP7</b>	Black and gold marble <b>OPP9</b>	Perfetto brown marble <b>OPP10</b>	Grey Stone marble <b>OPP11</b>	Guatemala green marble <b>OPP12</b>
Code	Velvet brown marble <b>OPP13</b>	Amani Bronze marble <b>OPP14</b>	Covelano white marble <b>OPP15</b>	Sahara noir marble <b>OPP16</b>	Port Laurent marble <b>OPP17</b>	Arabescato orobico grey marble <b>OPP20</b>	Calacatta violet marble <b>OPP21</b>			
Base in metallo Metal base										
Code	Shiny chrome metal <b>OPM1</b>	Brushed matt chrome metal <b>OPM2</b>	Brushed matt dark grey metal <b>OPM3</b>	RAL 9017 black painted metal <b>OPM6</b>	RAL 9016 white painted metal <b>OPM7</b>	Classic bronze painted metal <b>OPM9</b>	Golden beach painted metal <b>OPM10</b>	Gold pearl painted metal <b>OPM11</b>		
Code	Brushed copper metal <b>OPM12</b>	Brushed antique brass metal <b>OPM13</b>	Shiny black chrome metal <b>OPM14</b>	Brushed antique gold metal <b>OPM15</b>	Shiny brass chrome metal <b>OPM16</b>	Bronze metal <b>OPM17</b>	Anodyc Bronze metal <b>OPM18</b>			

Tavoli  
Tables

 <b>7TG101</b> Top in marmo/Marble top <b>7TG111</b> Top in metallo/Metal top <b>7TG121</b> Top in rovere massello/Solid oak top <b>7TG131</b> Top in vetro/Glass top Ø50 H50	 <b>7TG102</b> Top in marmo/Marble top <b>7TG112</b> Top in metallo/Metal top <b>7TG122</b> Top in rovere massello/Solid oak top <b>7TG132</b> Top in vetro/Glass top Ø60 H40	 <b>7TG103</b> Top in marmo/Marble top <b>7TG113</b> Top in metallo/Metal top <b>7TG123</b> Top in rovere massello/Solid oak top <b>7TG133</b> Top in vetro/Glass top Ø100 H35	 <b>7TG104</b> Top in marmo/Marble top <b>7TG114</b> Top in metallo/Metal top <b>7TG124</b> Top in rovere massello/Solid oak top <b>7TG144</b> Top in vetro/Glass top L120 P71 H35	<p>Top: marmo/rovere massello, spessore 20 mm Base: tubo di metallo rotondo, sezione 10 mm Top: marble/solid oak, 20 mm thick Base: square metal tube, section 10 mm</p> <p>Top: metallo, spessore 10 mm Base: tubo di metallo rotondo, sezione 10 mm Top: metal, 10 mm thick Base: square metal tube, section 10 mm</p>
 <b>7TG139</b> Top in marmo/Marble top <b>7TG140</b> Top impiallacciato rovere Oak veneer top Ø120 H74	 <b>7TG130</b> Top in marmo/Marble top <b>7TG150</b> Top impiallacciato rovere Oak veneer top L180 P110 H74	 <b>7TG134</b> Top in marmo/Marble top <b>7TG135</b> Top impiallacciato rovere Oak veneer top <b>7TG138</b> Top in vetro/Glass top L240 P110 H74	 <b>7TG136</b> Top in marmo/Marble top L300 P120 H74 <b>7TG137</b> Top impiallacciato rovere Oak veneer top <b>7TG143</b> Top in vetro/Glass top L310 P120 H74	

Finiture in vetro per tavoli e tavolini  
Glass finishes for tables and coffee tables

Top in vetro per 7TG138 e 7TG143 Glass top 7TG138 and 7TG143 	Transparent glass <b>OPV1</b>	Frosted glass <b>OPV2</b>	RAL 9016 traffic white back-painted glass <b>OPV3</b>	RAL 9017 traffic black back-painted glass <b>OPV4</b>	RAL 7044 silk grey back-painted glass <b>OPV5</b>	RAL 1019 grey beige back-painted glass <b>OPV6</b>	Chrome back-painted bronze glass <b>OPV9</b>	Chrome back-painted grey glass <b>OPV10</b>	Transparent bronze glass <b>OPV12</b>	Transparent grey glass <b>OPV13</b>
finiture vetri per i tavolini Glass finishes for coffee tables 	RAL 9016 traffic white back-painted glass <b>OPV3</b>	RAL 7044 silk grey back-painted glass <b>OPV5</b>	RAL 1019 grey beige back-painted glass <b>OPV6</b>	Chrome back-painted bronze glass <b>OPV9</b>	Chrome back-painted grey glass <b>OPV10</b>					

Finiture  
Finishes

Top in marmo Marble top  Code	 White Carrara marble <b>OPP1</b>	 Black Marquina marble <b>OPP2</b>	 Brown Emperador marble <b>OPP3</b>	 Grey Serena stone <b>OPP4</b>	 Beige Brera stone <b>OPP5</b>	 Calacatta gold marble <b>OPP7</b>	 Black and gold marble <b>OPP9</b>	 Perfetto brown marble <b>OPP10</b>	 Grey Stone marble <b>OPP11</b>	 Guatemala green marble <b>OPP12</b>			
Top in Gres Porcellanato Porcelain Stoneware Top  Code	 Nero Marquina <b>OPG2</b>	 Statuario Select <b>OPG3</b>	 Calacatta Royal <b>OPG4</b>	 Bianco Dolomite <b>OPG5</b>									
Top in legno Wooden top  Code	 Cherry stained oak <b>OPR1</b>	 Wengé stained oak <b>OPR2</b>	 Walnut stained oak <b>OPR3</b>	 Natural oak <b>OPR4</b>	 Black stained oak <b>OPR5</b>	 Cherry Milano stained oak <b>OPR6</b>	 Tobacco stained oak <b>OPR8</b>	 Grey taupe stained oak <b>OPR9</b>	 Whitened oak <b>OPR10</b>	 Charcoal stained oak <b>OPR11</b>	 Mahogany stained oak <b>OPR12</b>	 Moka matt stained oak <b>OPR15</b>	
Top in metallo Metal top  Code	 Brushed matt dark grey metal <b>OPM3</b>	 Classic bronze painted metal <b>OPM9</b>	 Golden beach painted metal <b>OPM10</b>	 Gold pearl painted metal <b>OPM11</b>	 Brushed copper metal <b>OPM12</b>	 Brushed antique brass metal <b>OPM13</b>	 Brushed antique gold metal <b>OPM15</b>	 Anodyc Bronze metal <b>OPM18</b>					
Base in metallo Metal base  Code	 Shiny chrome metal <b>*OPM1</b>	 Brushed matt chrome metal <b>OPM2</b>	 Brushed matt dark grey metal <b>OPM3</b>	 Classic bronze painted metal <b>OPM9</b>	 Brushed copper metal <b>OPM12</b>	 Brushed antique brass metal <b>OPM13</b>	 Shiny black chrome metal <b>*OPM14</b>	 Brushed antique gold metal <b>OPM15</b>	 Shiny brass chrome metal <b>*OPM16</b>	 Bronze metal <b>OPM17</b>	 Anodyc Bronze metal <b>OPM18</b>		

\* non disponibile per i tavoli 7TG137 e 7TG143  
\* not available for 7TG137 and 7TG143 tables



# Wave

DESIGN  
LUCA ERBA  
2021

# Xela

DESIGN  
MORENA COLOMBO  
2018

430

LIFESTYLE COLLECTION 2021 \_ MARELLI

## Tavoli Tables

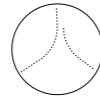

Top: rovere impiallacciato o marmo, spessore 20 mm  
Base: tubo di metallo quadrato, sezione 15 mm  
Top: oak veneer or marble, 20 mm thick  
Base: square metal tube, section 15 mm

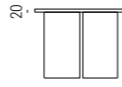

Top in vetro extralight, temperato, spessore 6 mm  
Base: tubo di metallo quadrato, sezione 15 mm  
Top: extralight tempered glass, 6 mm thick  
Base: square metal tube, section 15 mm

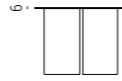

**7WA101**  
Top marmo/Marble top  
**7WA111**  
Top vetro/Glass top  
ø50 H47

**7WA102**  
Top marmo/Marble top  
**7WA112**  
Top vetro/Glass top  
ø60 H37

**7WA103**  
Top marmo/Marble top  
**7WA113**  
Top vetro/Glass top  
ø100 H27

**7WA104**  
Top marmo/Marble top  
**7WA114**  
Top vetro/Glass top  
ø120 H27

## Finiture Finishes

Top in marmo  
Marble top

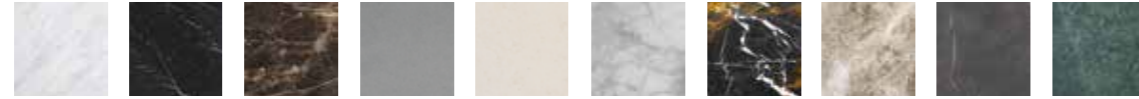

White Carrara marble **OPP1**   Black Marquina marble **OPP2**   Brown Emperador marble **OPP3**   Grey Serena stone **OPP4**   Beige Brera stone **OPP5**   Calacatta gold marble **OPP7**   Black and gold marble **OPP9**   Perfetto brown marble **OPP10**   Grey Stone marble **OPP11**   Guatemala green marble **OPP12**

Top in marmo  
Marble top

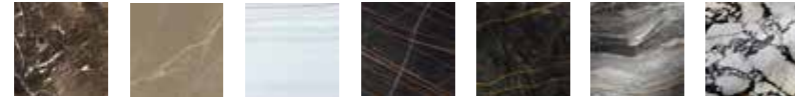

Velvet brown marble **OPP13**   Amani Bronze marble **OPP14**   Covelano white marble **OPP15**   Sahara noir marble **OPP16**   Port Laurent marble **OPP17**   Arabescato orobico grey marble **OPP20**   Calacatta violet marble **OPP21**

Code

Top in Gres Porcellanato  
Porcelain Stoneware Top



Nero Marquina **OPG2**   Statuario Select **OPG3**   Calacatta Royal **OPG4**   Bianco Dolomite **OPG5**

Code

Top in vetro  
Glass top



RAL 9016 traffic white back-painted glass **OPV3**   RAL 9017 traffic black back-painted glass **OPV4**   RAL 7044 silk grey back-painted glass **OPV5**   RAL 1019 grey beige back-painted glass **OPV6**   Chrome back-painted bronze glass **OPV9**   Chrome back-painted grey glass **OPV10**

Base in metallo  
Metal Base

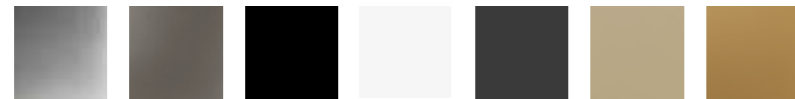

Brushed matt chrome metal **OPM2**   Brushed matt dark grey metal **OPM3**   RAL 9017 black painted metal **OPM6**   RAL 9016 white painted metal **OPM7**   Classic bronze painted metal **OPM9**   Golden beach painted metal **OPM10**   Gold pearl painted metal **OPM11**



Brushed copper metal **OPM12**   Brushed antique brass metal **OPM13**   Delabre pewter brushed metal **OPM19**   Delabre brass brushed metal **OPM20**

431

LIFESTYLE COLLECTION 2021 \_ MARELLI

## Tavoli Tables

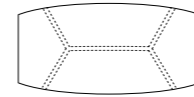

**7XL101**  
Tavolo con base in metallo e top in marmo  
Table with metal base and marble top  
L240 P120 H74

Top: marmo, spessore 20 mm  
Base: metallo spessore 5 mm  
Top: marble, 6 mm thick  
Base: metal, 5 mm thick

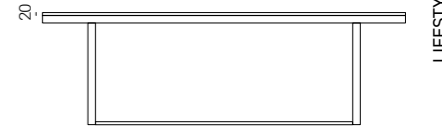

## Finiture Finishes

Top in marmo  
Marble top



White Carrara marble **OPP1**   Black Marquina marble **OPP2**   Brown Emperador marble **OPP3**   Grey Serena stone **OPP4**   Beige Brera stone **OPP5**   Calacatta gold marble **OPP7**   Black and gold marble **OPP9**   Perfetto brown marble **OPP10**   Grey Stone marble **OPP11**   Guatemala green marble **OPP12**

Code

Top in marmo  
Marble top

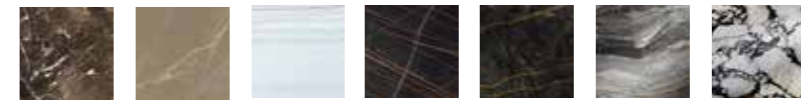

Velvet brown marble **OPP13**   Amani Bronze marble **OPP14**   Covelano white marble **OPP15**   Sahara noir marble **OPP16**   Port Laurent marble **OPP17**   Arabescato orobico grey marble **OPP20**   Calacatta violet marble **OPP21**

Code

Top in Gres Porcellanato  
Porcelain Stoneware Top



Nero Marquina **OPG2**   Statuario Select **OPG3**   Calacatta Royal **OPG4**   Bianco Dolomite **OPG5**

Code

Base in metallo  
Metal base



Brushed matt dark grey metal **OPM3**   RAL 9017 black painted metal **OPM6**   RAL 9016 white painted metal **OPM7**   Classic bronze painted metal **OPM9**   Golden beach painted metal **OPM10**   Gold pearl painted metal **OPM11**   Brushed copper metal **OPM12**   Brushed antique brass metal **OPM13**   Brushed antique gold metal **OPM15**   Anodyc Bronze metal **OPM18**

Code

**graphic**

Matteo Paoloni

**concept and stylist creator**

Morena Colombo

**photo**

IKB Studio

all rights reserved © 2021

**marelli****Giulio Marelli Italia SpA**

Via Indipendenza 159 20821 Meda (MB) Italia

T ++39 0362 342116

info@giuliomarelli.com www.giuliomarelli.com





**marelli**

**Giulio Marelli Italia SpA**

Via Indipendenza 159 20821 Meda (MB) Italia T ++39 0362 342116  
info@giuliomarelli.com www.giuliomarelli.com