



Matheus | Brera | Thor | Atene

MATHEUS sofas 9MU206 cm 260x100x88h | Fabric: cat. C art. Koala col. 120 **Extra cushions:** 2 x 9MU101 cm 50x50 with band | Fabric: cat. C art. Koala col. 120 | 1 x 9CU106 cm 45x45 | Fabric: cat. C art. Koala col. 103 **BRERA armchairs** with high back 9BRE106 cm 80x82x101h | Fabric: cat. H art. Rubelli Spritz col. 26 bluetette | Base: OPM9 classic bronze painted metal **ATENE coffee tables** 7AT104 ø cm 100x30h | 7AT101 ø cm 50x40h | Top: OPP20 Arabescato Orobico grey marble | Base: OPM14 shiny black chrome metal **THOR side table** 7TH111 cm 80x80x27h OPP20 Arabescato Orobico grey marble | Base: OPM14 shiny black chrome metal





MATHEUS sofas 9MU206 cm 260x100x88h | Fabric: cat. C art. Koala col. 120 | Extra cushions: 2 x 9MU101 cm 50x50 with band | Fabric: cat. C art. Koala col. 120 | 1 x 9CU106 cm 45x45 | Fabric: cat. C art. Koala col. 103 **BRERA armchairs** with high back 9BRE106 cm 80x82x101h | Fabric: cat. H art. Rubelli Spritz col. 26 bluette | Base: OPM9 classic bronze painted metal **ATENE coffee tables** 7AT104 ø cm 100x30h | 7AT101 ø cm 50x40h | Top: OPP20 Arabescato Orobico grey marble | Base: OPM14 shiny black chrome metal



Detail of OPP20 Arabescato Orobianco grey marble
> **ATENE coffee tables** 7AT104 ø cm 100x30h | 7AT101 ø cm 50x40h | Top: OPP20 Arabescato Orobianco grey marble | Base: OPM14 shiny black chrome metal





MATHEUS composition cm 340x225 made of : Side element 9MU210 cm 240x100 | Chaise longue 9MU108 cm 225x100 | Ottoman 9MU114 cm 100x100 | Fabric: cat. H art. Sahco Avalon 2 col. 002 | Base: OPM15 antique gold brushed metal | Extra cushions: 2 x 9MU101 cm 50x50 with band Fabric: cat. H art. Sahco Avalon 2 col. 0047 | 3 x 9CU106 cm 45x45 Fabric: cat. H art. Casamance Mollino 4718-0365 Tourterelle **TWIG coffee table** 7TG103 ø cm 100x35h | Top: OPP7 Calacatta gold | Base: OPM15 antique gold brushed metal **THOR side table** 7TH204 cm 50x50x50h OPM20 Délabré brass brushed metal **LEAF server table** 7LE101 cm 64x25x51h OPM16 shiny brass chrome metal **CLIP side table** ø cm 40x50h OPM16 shiny brass chrome metal

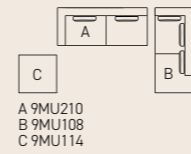

Matheus | Twig | Thor | Clip | Leaf



MATHEUS composition cm 340x225 made of : Side element 9MU210 cm 240x100 | Chaise longue 9MU108 cm 225x100 | Ottoman 9MU114 cm 100x100 | Fabric: cat. H art. Sahco Avalon 2 col. 002 | Base: OPM15 antique gold brushed metal | Extra cushions: 2 x 9MU101 cm 50x50 with band | Fabric: cat. H art. Sahco Avalon 2 col. 0047 | 3 x 9CU106 cm 45x45 | Fabric: cat. H art. Casamance Mollino 4718-0365 Tourterelle **TWIG coffee table** 7TG103 ø cm 100x35h | Top: OPP7 Calacatta gold | Base: OPM15 antique gold brushed metal **THOR side table** 7TH204 cm 50x50x50h OPM20 Délabré brass brushed metal **LEAF server table** 7LE101 cm 64x25x51h OPM16 shiny brass chrome metal

> Detail of **MATHEUS sofa** and **TWIG table** 7TG103 ø cm 100x35h with OPP7 Calacatta marble top and OPM15 antique gold brushed metal base





Matheus | Tab | Thor | Mini

MATHEUS composition cm320x300 Fabric: cat. H art. Sahco Zero col. 12 | Base: OPM18 anodyc bronze painted metal **Extra cushions:** 1 x 9CU106 cm45x45 Fabric: cat. H art. Rubelli Spritz col. 16 moro | 2 x 9CU103 cm40x40 Fabric: cat. H art. Misia M260 7 01 col. 01 Sépia **TAB coffee table** 7TAB114 øcm125x36h Base: OPM18 anodyc bronze painted metal | Upper top: OPP3 Emperador brown marble | Lower top: OPV9 chrome back-painted bronze metal **THOR side table** 7TH204 cm50x50x50h OPM15 antique gold brushed metal

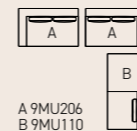

marelli



MINI side table 7TX160 cm25x40x50h OPM15 antique gold brushed meta **MATHEUS composition** cm320x300 Fabric: cat. H art. Sahco Zero col. 12

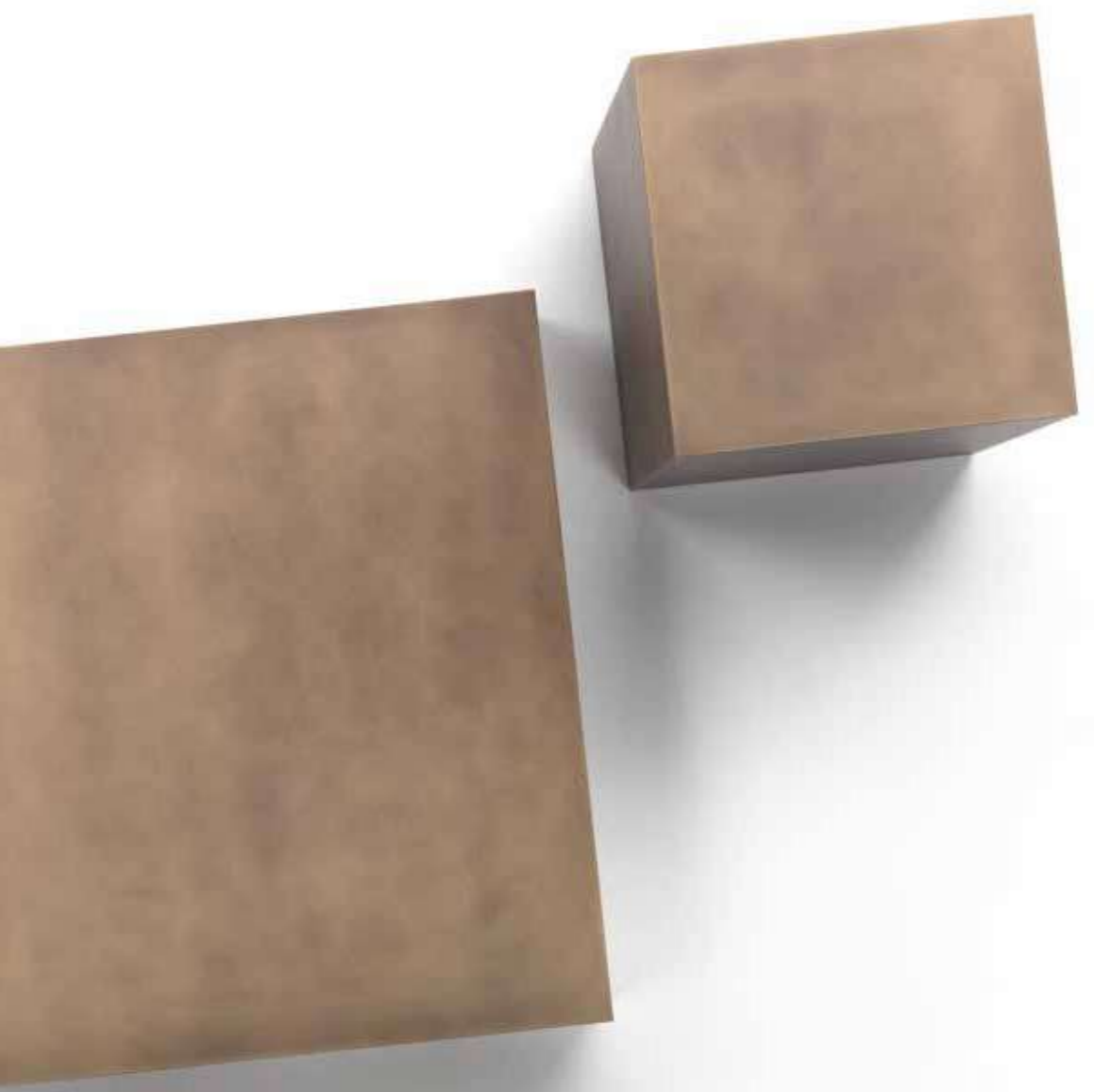

THOR side tables 7TH204 cm50x50x50h, 7TH202 cm100x100x19h OPM15 antique gold brushed metal





Matheus | Kyoto | Thor | Atene

MATHEUS composition cm320x225 Fabric: cat. H art. Designers Guild Glenville F1872/06 nutmeg | Base: OPM18 anodyc bronze painted metal **Decorative cushions:**
 3 x 9MU101 cm50x50 with band Fabric: cat. H art. Designers Guild Glenville F1872/06 nutmeg | 1 x 9CU105 cm50x50, 1 x 9CU103 cm40x40 Fabric: cat. H art.
 Casamance Mollino 47180365 Tourterelle **KYOTO coffee tables** 7KY101 øcm40x48h, 7KY109 øcm100x38h Base: OPM16 shiny brass chrome metal | Top: OPP2
 Marquinia black marble **THOR side table** 7TH102 cm100x100x19h OPP2 Marquinia black marble

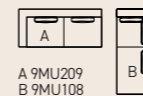

marelli





A 9MU206

MATHEUS composition cm320x100x88h Fabric: cat. H art. Sahco Avalon col. 021 | Base: OPM15 antique gold brushed metal **Extra cushions:** 2 x 9MU102 cm60x60 with band | 1 x 9CU106 cm45x45 Fabric: cat. H art. Sahco Avalon col. 021 | 1 x 9CU106 cm45x45 Fabric: cat. H art. Rubelli Vello d'Oro 30085-015 pavone **ATENE coffee tables** 7AT105 øcm120x30h, 7AT101 øcm50x40h Base: OPM17 bronze metal | Top: OPP3 Emperador brown marble



ATENE coffee tables 7AT105 øcm120x30h, 7AT101 øcm50x40h Base: OPM17 bronze metal | Top: OPP3 Emperador brown marble





ANDY + MATHEUS composition cm 400x405
 Fabric: cat. H art. Rubelli Spritz col. 15 Sabbia
 Leather: cat. Lusso art. Nabuk C3406
 Base: OPM17 bronze metal

Extra cushions:
 1 x **9CU104 cm 60x60**
 1 x **9CU103 cm 40x40**
 Fabric: cat. H art. Rubelli Spritz col. 16 moro

2 x **9CU106 cm 45x45**
 Fabric: cat. H art. Rubelli Spritz col. 15 sabbia

1 x **9CU106 cm 45x45**
 2 x **9CU104 cm 60x60**
 Fabric: cat. E art. Dolomiti col. 28

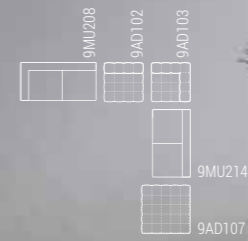

CLIPPER armchairs
9CLX107 cm 70x76x75h
 External side: leather cat. Lusso art. Nabuk col. C3407 mogano
 Internal side: fabric cat. E art. Dolomiti col. 28
 Base: OPM17 bronze metal
KYOTO coffee tables:
7KY101 ø cm 40x48h
 Base: OPM16 shiny brass chrome metal
 Top: OPP7 Calacatta gold marble

7KY109 ø cm 100x38h
 Base: OPM18 anodized bronze painted metal
 Top: OPP7 Calacatta gold marble

THOR side table
7TH111 cm 80x80x27h
 OPP7 Calacatta gold marble
 with OPM15 antique gold brushed metal base

ELLE coffee tables:
7EL109 cm 60x60x27h
7EL107 cm 50x50x43h
 OPM15 antique gold brushed metal



Matheus

DESIGN
STUDIO MARELLI
2015

marelli

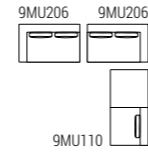

MATHEUS composition cm 320x300x88h
Fabric: cat. E art. Baltimora col. 10
Base: OPM9 classic bronze painted metal

Extra Cushions:
2 x **9CU103 cm 40x40**
Fabric: cat. H art. Rubelli Spritz col. 25 Lichene
1 x **9CU105 cm 50x50**
Fabric: cat. E art. Burri col. 6

CLIPPER swivel armchairs
9CLX104 cm 70x80x91h
Fabric: cat. E art. Burri col. 6
Swivel base: OPM6 RAL 9017 traffic black painted metal

TWIG coffee tables
7TG103 ø cm 100x35h
7TG101 ø cm 50x50h
Base: OPM6 RAL 9017 traffic black painted metal
Top: OPP11 Grey Stone marble

CLIP coffee table
7CL117 ø cm 40x40h
OPM14 shiny black chrome metal

ELLE side table
7EL109 cm 60x60x27h
OPM6 RAL 9017 traffic black painted metal



CLIPPER swivel armchair
9CLX104 cm 70x80x91h
Fabric: cat. E art. Burri col. 6
Swivel base: OPM6 RAL 9017 traffic black painted metal

CLIP coffee table
7CL117 ø cm 40x40h
OPM14 shiny black chrome metal



TWIG coffee tables
7TG103 ø cm 100x35h
7TG101 ø cm 50x50h
Base: OPM6 RAL 9017 traffic black painted metal
Top: OPP11 Grey Stone marble



MATHEUS sofa
9MU204 cm 240x100x88h
 Fabric: cat. E art. Baltimora col. 35
 Base: OPM14 shiny black chrome metal

Extra cushions:
 2 x **9CU103 cm 40x40**
 Fabric: cat. E art. Baltimora col. 35
 1 x **9CU103 cm 40x40**
 Leather: cat. Lusso art. Seta col. Militare

JOY swivel armchair
9JY101 cm 75x82x99h
 Leather: cat. Lusso art. Seta col. Militare
 Base: OPM17 bronze metal

DUNE coffee table
7DU108 ø cm 80x37h
 Base: OPR15 moka matt stained oak + OPM14 shiny
 black chrome metal
 Top: OPP7 Calacatta gold marble

CLIP coffee table
7CL118 ø cm 40x50h
 OPM14 shiny black chrome metal

THOR side table
7TH111 cm 80x80x27h
 OPP11 Grey Stone marble
 Base: OPM14 shiny black chrome metal



ANDY + MATHEUS composition cm 400x405
 Fabric: cat. H art. Rubelli Spritz col. 15 Sabbia
 Leather: cat. Lusso art. Nabuk C3406
 Base: OPM17 bronze metal

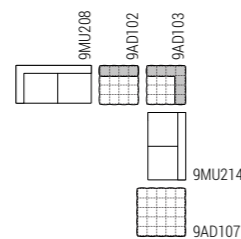

Extra cushions:
 1 x **9CU104 cm 60x60**
 1 x **9CU103 cm 40x40**
 Fabric: cat. H art. Rubelli Spritz col. 16 moro

2 x **9CU106 cm 45x45**
 Fabric: cat. H art. Rubelli Spritz col. 15 sabbia

1 x **9CU106 cm 45x45**
 2 x **9CU104 cm 60x60**
 Fabric: cat. E art. Dolomiti col. 28

CLIPPER armchairs
9CLX107 cm 70x76x75h
 External side: leather cat. Lusso art. Nabuk col. C3407 mogano
 Internal side: fabric cat. E art. Dolomiti col. 28
 Base: OPM17 bronze metal
KYOTO coffee tables:
7KY101 ø cm 40x48h
 Base: OPM16 shiny brass chrome metal
 Top: OPP7 Calacatta gold marble

7KY109 ø cm 100x38h
 Base: OPM18 anodyc bronze painted metal
 Top: OPP7 Calacatta gold marble

THOR side table
7TH111 cm 80x80x27h
 OPP7 Calacatta gold marble
 with OPM15 antique gold brushed metal base

ELLE coffee tables:
7EL109 cm 60x60x27h
7EL107 cm 50x50x43h
 OPM15 antique gold brushed metal

CLIP HEXAGONAL side table
7CLX101 ø cm 40x50h
 OPM17 bronze metal





Detail of **MATHEUS** sofa and **THOR** side table
in Calacatta marble

CLIPPER armchairs
9CLX107 cm 70x76x75h
External side: leather cat. Lusso art. Nabuk col. C3407 mogano
Internal side: fabric cat. E art. Dolomiti col. 28
Base: OPM17 bronze metal

CLIP HEXAGONAL side table
7CLX101 ø cm 40x50h
OPM17 bronze metal



MATHEUS sofa
9MU203 cm 220x100x88h
 Fabric: cat. H art. Rubelli Spritz col. 25 bluetto
 Base: OPM16 shiny brass chrome metal

Extra cushions:
 2 x **9CUT106 cm 45x45** in the same fabric

CLIP side table
7CL133 ø cm 60x40h
 Base: OPM16 shiny brass chrome metal
 Top: OPP13 Velvet brown marble

BREAK side table
7BR117 ø cm 40x45h
 Base: OPM14 shiny black chrome metal
 Top: OPV12 transparent bronze glass





MATHEUS composition cm 300x320
Fabric: cat. H art. Rubelli Spritz col. 07 castagna
Base: OPM9 Classic bronze painted metal

Extra cushions:
3 x **9MU101 cm 50x50** with band
Fabric: cat. H art. Rubelli Spritz col. 17 Siena
2 x **9CU106 cm 45x45**
Fabric: cat. H art. Rubelli Spritz col. 07 castagna

FRAME coffee tables
7FR122 ø cm 120x28h
7FR166 ø cm 40x50h
Base: OPM15 antique gold brushed metal
Top: OPP3 shiny Emperador brown marble

CLIP coffee table
7CL117 ø cm 40x40h
OPM15 antique gold brushed metal

LEAF side table
7LE101 cm 64x25x51h
OPM15 antique gold brushed metal

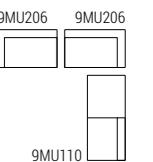

Schede tecniche

TECHNICAL INFORMATION

Fusto in legno massello e legno multistrato con cinghie elastiche intrecciate. Imbottitura in poliuretano espanso rivestito in vellutino bianco. Cuscini di schienale in Piumafib, una speciale miscela ipoallergenica di vera piuma e fibra poliestere siliconata*. Cuscini di seduta costituiti da un inserto in poliuretano con densità di 30 Kg/m³ ricoperto da un trapuntino di vera piuma imbottito a scomparti*. Completamente sfoderabile in tessuto, non sfoderabile in pelle e finta pelle.

Kit letto non disponibile.

*Manutenzione dei cuscini contenenti piuma:

I cuscini contenenti piuma tendono a deformarsi con l'utilizzo. Per mantenerne la forma è necessario, anche dopo un breve utilizzo, battere e sprimacciare ripetutamente i cuscini. Non utilizzare mai battipanni o aspirapolvere. A coloro che non desiderassero seguire queste indicazioni o che volessero un divano dall'aspetto meno vissuto, raccomandiamo di preferire dei cuscini in gomma.

Carcasse en bois massif et multiplis muni de bandes élastiques entrecroisées et finie de mousse polyuréthane couverte de dacron. Coussins de dossier en Piumafib, un mélange hypoallergénique spécial de véritable duvet et fibre polyester siliconisée. Les coussins d'assise sont composés d'un noyau en mousse polyuréthane d'une densité de 30 kg/m³ couvert de véritable duvet broché en compartiments*. Revêtement complètement déhoussable en tissu, fixe en cuir et cuir look. Pas disponible en canapé-lit.*

*Entretien de coussins en duvet:

Coussins en duvet ont tendance à perdre leur forme dû à l'usage. Pour en conserver la forme il est nécessaire, aussi après un usage court, de régulièrement battre les coussins. Ne jamais utiliser la tapette ou l'aspirateur. A ceux qui ne désirent pas suivre ces indications ou qui souhaitent un canapé qui ait l'air moins "usé", nous conseillons vivement de choisir des coussins en mousse polyuréthane.

Frame made of solid wood and multi-ply wood with interwoven elastic straps. The upholstery is made of polyurethane foam, covered with dacron. The back cushions are filled with Piumafib, a special hypoallergenic mixture of feathers and siliconised polyfibre. The seat cushions are made of a foam insert with density of 30 Kg/m³, covered with a feather compartments quilt*. Fully removable fabric covers, fixed leather and artificial leather covers. Sofa-bed is not available.*

*Maintenance of feather cushions:

Cushions filled with feathers tend to change their shape with use. In order to keep their shape it is necessary, even after a short use, to plump up the cushions repeatedly. Never use carpet beater or vacuum cleaner. We recommend to choose foam cushions to those who do not wish to follow these instructions or to have a "used look" sofa.

Для производства каркаса используется массив дерева и многослойная фанера в сочетании с перекрещивающимися эластичными ремнями. Наполнение из полиуретана, обернутого в белый бархат. Наполнение подушек спинки выполнено из материала Piumafib – специальной, не вызывающей аллергии смеси из натурального пуха и полиэфирных силиконовых волокон. Подушки сиденья: стеганые по отсекам, наполнение из натурального пуха с вставками из полиуретана плотностью 30 кг/м³ *. Полностью съемные чехлы из ткани, несъемные чехлы из кожи.*

Das Gestell besteht aus Massiv- und Schichtholz, mit geflochtenen Gummigurten, gepolstert mit Polyurethanschaumstoff, mit Dacron bezogen. Rueckenkissen aus Piumafib, einer hypoallergischen speziellen Mischung aus echter Daune und silikonisierter Polyesterfaser. Die Sitzkissen bestehen aus einem Schaumkern mit Dichte 30 Kg/m³ mit einer gekammerten Daunenauflage*. Stoffbezüge alle abziehbar, Leder und Kunstleder festbezogen. Als Bettsofa nicht verfügbar.*

*Wartungsanleitungen fuer Daunenkissen:

Die Kissen, die Daunen enthalten, neigen dazu, sich durch Gebrauch zu verformen. Um die ursprüngliche Form zu halten, ist es notwendig, auch nach kurzem Gebrauch, die Kissen wiederholt aufzuschütteln. Keinen Ausklopfper oder Staubsauger verwenden. Unseren Kunden, die diese Anweisungen nicht befolgen moechten, oder die kein Sofa mit solchem "gebrauchten" Aussehen haben moechten, empfehlen wir Polyurethan-Kissen.

Вариант со спальным местом не предусмотрен.

*Эксплуатация подушек с пуховым наполнением:

В процессе эксплуатации подушки с пуховым наполнением могут деформироваться, во избежание чего их необходимо слегка взбивать вручную даже после непродолжительного нахождения на диване. Использование в этих целях пылесоса или выбивалки для одежды категорически запрещено. Если клиент не планирует следовать данным инструкциям и хочет, чтобы подушки сиденья и спинки проминались по минимуму, посоветуйте выбрать наполнение только из полиуретана, полностью исключив натуральный пух.

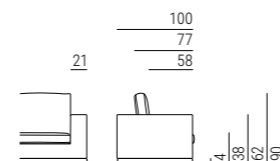

Divani Sofas

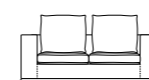

9MU201
L180 P100 H62



9MU202
L200 P100 H62

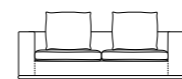

9MU203
L220 P100 H62



9MU204
L240 P100 H62

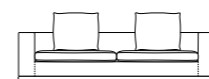

9MU205
L260 P100 H62

Elementi componibili Modular elements

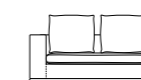

9MU206
L160 P100 H62

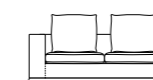

9MU207
L180 P100 H62

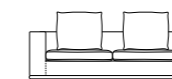

9MU208
L200 P100 H62

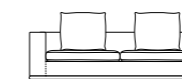

9MU209
L220 P100 H62

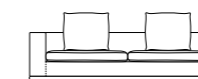

9MU210
L240 P100 H62



9MU212
L140 P100 H62



9MU213
L160 P100 H62



9MU214
L180 P100 H62

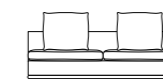

9MU215
L200 P100 H62



9MU216
L100 P100 H62
Elemento angolare
Corner element



9MU220
L80 P100 H62



9MU221
L80 P100 H38

Dormeuse
Longchair

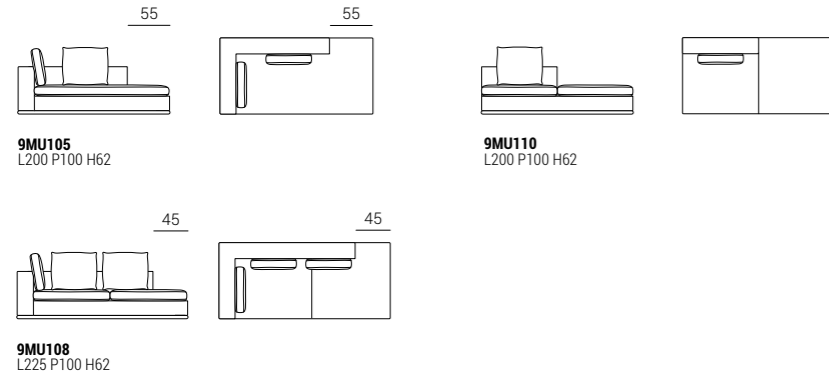

Pouf e accessori
Ottomans and accessories



Finiture base metallo
Metal base finishes

Code	Shiny chrome metal OPM1	Brushed matt chrome metal OPM2	Brushed matt dark grey metal OPM3	RAL 9017 black painted metal OPM6	Classic bronze painted metal OPM9	Golden beach painted metal OPM10	Gold pearl painted metal OPM11	Brushed copper metal OPM12
Code	Brushed antique brass metal OPM13	Shiny black chrome metal OPM14	Brushed antique gold metal OPM15	Shiny brass chrome metal OPM16	Bronze metal OPM17	Anodized bronze metal OPM18	Dark bronze painted metal OPM21	