



BED AND SOFA BED COLLECTION 2023

marelli

BED AND SOFA BED COLLECTION 2023

Indice prodotti

PRODUCT LIST

Letti

BEDS

Brandon
PAGE 70



Brandon Quilted
PAGE 60

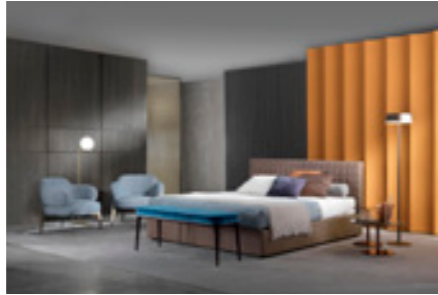

Dexter
PAGE 20



Dexter Box
PAGE 28

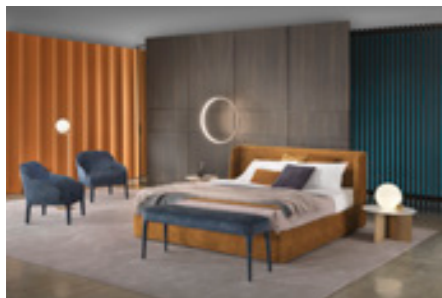

Nolan
PAGE 80

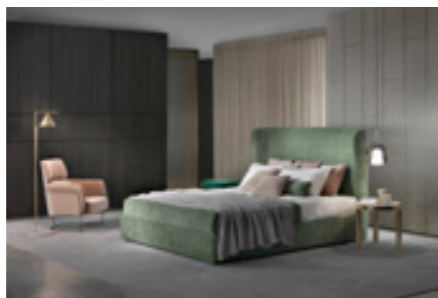

Nolan Classic
PAGE 90



Parker
PAGE 40

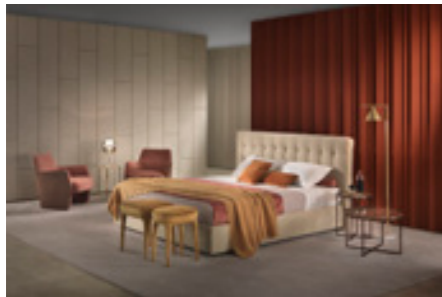

Ritz
PAGE 8

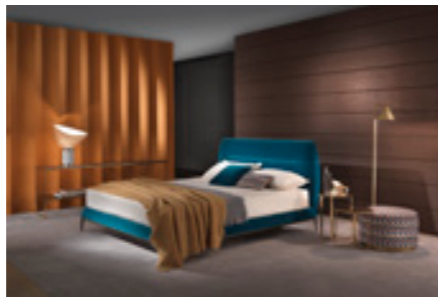

Noah
PAGE 50

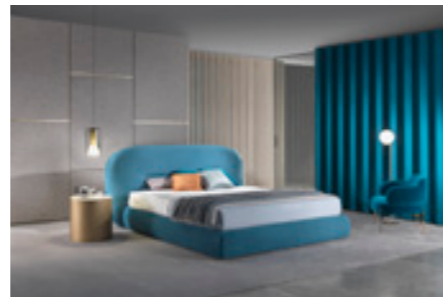

Divani Letto

SOFA BEDS

Adam
PAGE 102



Demon
PAGE 110



Kendall
PAGE 118



Logan
PAGE 132



Lucas
PAGE 142



Letti BEDS

marelli



RITZ bed 5RIT102 cm 190x220x112h Fabric: cat. F/G art. Misia Aime M188 613 Seychelles Base: OPM15 antique gold brushed metal **Cushions:** 1 x 9CU107 cm 50x25 Fabric: cat. H art. Casamance Paddington 485704 94 | 1 x 9CU106 cm 45x45 Fabric: cat. F/G art. Misia Aime M188 613 Seychelles **MOON ottoman** 9MN102 ø cm 60x40h Fabric: cat. H art. Casamance Paddington 485704 94 Base: OPM15 antique gold brushed metal **CLIP side tables** 7CL117 ø cm 40x40h | 7CL118 ø cm 40x50h OPM16 shiny brass chrome metal **FRAME console** 7FR130 cm 200x40x70h Structure: OPM16 shiny brass chrome metal Upper top: OPP13 Velvet brown marble Lower top: OPV9 chrome back-painted bronze metal



MOON ottoman 9MN102 ø cm 60x40h Fabric: cat. H art. Casamance Paddington 485704 94 Base: OPM15 antique gold brushed metal **CLIP side tables** 7CL117 ø cm 40x40h | 7CL118 ø cm 40x50h OPM16 shiny brass chrome metal



RITZ bed 5RIT102 cm 190x220x112h Fabric: cat. F/G art. Misia Aime M188 613 Seychelles Base: OPM15 antique gold brushed metal **Cushions:** 1 x 9CU107 cm 50x25 Fabric: cat. H art. Casamance Paddington 485704 94 | 1 x 9CU106 cm 45x45 Fabric: cat. F/G art. Misia Aime M188 613 Seychelles **MOON ottoman** 9MN102 ø cm 60x40h Fabric: cat. H art. Casamance Paddington 485704 94 Base: OPM15 antique gold brushed metal **CLIP side tables** 7CL117 ø cm 40x40h | 7CL118 ø cm 40x50h OPM16 shiny brass chrome metal **FRAME console** 7FR130 cm 200x40x70h Structure: OPM16 shiny brass chrome metal Upper top: OPP13 Velvet brown marble Lower top: OPV9 chrome back-painted bronze metal



RITZ bed 5RIT102 cm 190x220x112h Fabric: cat. F/G art. Misia Aime M188 613 Seychelles Base: OPM15 antique gold brushed metal **Cushions:** 1 x 9CU107 cm 50x25 Fabric: cat. H art. Casamance Paddington 485704 94 | 1 x 9CU106 cm 45x45 Fabric: cat. F/G art. Misia Aime M188 613 Seychelles **MOON ottoman** 9MN102 ø cm 60x40h Fabric: cat. H art. Casamance Paddington 485704 94 Base: OPM15 antique gold brushed metal **CLIP side tables** 7CL117 ø cm 40x40h | 7CL118 ø cm 40x50h OPM16 shiny brass chrome metal



FRAME console 7FR130 cm 200x40x70h Structure: OPM16 shiny brass chrome metal Upper top: OPP13 Velvet brown marble Lower top: OPV9 chrome back-painted bronze metal



Detail of the **RITZ bed** headboard



DEXTER bed 5DEX102 cm 195x225x100h Leather: cat. Lusso art. Nabuk C3411 betulla with leather profile Base: OPM15 antique gold brushed metal **Cushions:** 1 x 9CU107 cm 25x50 | 1 x 9CU106 cm 45x45 Fabric: cat. H art. Casamance Tamise 485304 16 | 1 x 9CU106 cm 45x45 Fabric: cat. H art. Casamance Manade B424833 23 champagne **THOR side table** 7TH103 cm 40x40x40h OPP15 Covelano white marble **CLIP side table** 7CL118 ø cm 40x50h OPM16 shiny brass chrome metal **KYOTO cupboard** 7KY210 cm 100x50x105h Wooden structure: OPR15 moka matt stained oak Marble top: OPP3 Emperador brown marble Metal: OPM15 antique gold brushed metal



THOR side table 7TH103 cm 40x40x40h OPP15 Covelano white marble **CLIP side tables** 7CL118 ø cm 40x50h OPM16 shiny brass chrome metal



DEXTER bed 5DEX102 cm 195x225x100h Leather: cat. Lusso art. Nabuk C3411 betulla with leather profile Base: OPM15 antique gold brushed metal **Cushions:** 1 x 9CU107 cm 25x50 | 1 x 9CU106 cm 45x45 Fabric: cat. H art. Casamance Tamise 485304 16 | 1 x 9CU106 cm 45x45 Fabric: cat. H art. Casamance Manade B424833 23 champagne **THOR side table** 7TH103 cm 40x40x40h OPP15 Covelano white marble **CLIP side table** 7CL118 ø cm 40x50h OPM16 shiny brass chrome metal **KYOTO cupboard** 7KY210 cm 100x50x105h Wooden structure; OPR15 moka matt stained oak Marble top: OPP3 Emperador brown marble Metal: OPM15 antique gold brushed metal



KYOTO cupboard 7KY210 cm 100x50x105h Wooden structure: OPR15 moka matt stained oak Marble top: OPP3 Emperador brown marble Metal: OPM15 antique gold brushed metal



DEXTER BOX bed with storage base 5DXB202 cm 195x225x100h Fabric: cat. H art. Casamance Manade B4248 29 13 Camel with piping in Gros Grein 67 Cognac
Cushions: 1 x 9CU107 cm 25x50 Fabric: cat. H art. Casamance Lanata 4454 09 60 | 1 x 9CU106 cm 45x45 Fabric: cat. H art. Casamance Manade B4248 29 13 Camel
 | 1 x 9CU106 cm 45x45 Fabric: cat. H art. Casamance Lucy 5027 06 74 Ardoise | 1 x 9CU106 cm 45x45 Fabric: cat. H art. Casamance Lucy 5027 09 83 Camel **PARIS**
armchairs 9PAR201X cm 73x75x76h **PARIS bench** 9PAR107X cm 130x40x50h Fabric: cat. H art. Casamance Manade B4248 5091 Pétrole Base covered in the same
 fabric **WAVE coffee tables** 7WA101 ø cm 50x47h | 7WA102 ø cm 60x37h Base: OPM20 délabré brass brushed metal Top: OPP7 Calacatta marble top





DEXTER BOX bed with storage base 5DXB202 cm 195x225x100h Fabric: cat. H art. Casamance Manade B4248 29 13 Camel with piping in Gros Grein 67 Cognac
Cushions: 1 x 9CU107 cm 25x50 Fabric: cat. H art. Casamance Lanata 4454 09 60 | 1 x 9CU106 cm 45x45 Fabric: cat. H art. Casamance Manade B4248 29 13 Camel
 | 1 x 9CU106 cm 45x45 Fabric: cat. H art. Casamance Lucy 5027 06 74 Ardoise | 1 x 9CU106 cm 45x45 Fabric: cat. H art. Casamance Lucy 5027 09 83 Camel **PARIS**
armchairs 9PAR201X cm 73x75x76h **PARIS bench** 9PAR107X cm 130x40x50h Fabric: cat. H art. Casamance Manade B4248 5091 Pétrole Base covered in the same
 fabric **WAVE coffee tables** 7WA101 ø cm 50x47h | 7WA102 ø cm 60x37h Base: OPM20 délabré brass brushed metal Top: OPP7 Calacatta marble top



DEXTER BOX bed with storage base 5DXB202 cm 195x225x100h Fabric: cat. H art. Casamance Manade B4248 29 13 Camel with piping in Gros Grein 67 Cognac
PARIS bench 9PAR107X cm 130x40x50h Fabric: cat. H art. Casamance Manade B4248 5091 Pétrole Base covered in the same fabric **WAVE coffee tables** 7WA101 ø cm 50x47h | 7WA102 ø cm 60x37h Base: OPM20 délabré brass brushed metal Top: OPP7 Calacatta marble top





Details of headboard and decorative cushions



PARKER bed 5PAR102 cm 205x220x113 Fabric: cat. H art. Dedar Belsuede col. 005 **Cushions:** 2 x 9ROL101 ø cm 10x58h Fabric: cat. H art. Casamance Manade B4248 18 36 | 1 x 9CU107 cm 25x50 Fabric: cat. H art. Casamance Lanata 4454 09 60 | 1 x 9CU106 cm 45x45 Fabric: cat. Manade B4248 29 13 Camel **PARIS footstools** with covered base 9PAR105X cm 41x31x50h Fabric: cat. H art. Sahco Avalon 2 col. 50 **CLIPPER armchairs** 9CLX105 cm 70x76x75h Outer side: Leather cat. Lusso art. Nabuk marrone Inner side: Fabric cat. H art. Casamance Madame B4248 43 63 **FRAME side tables** 7FR166 ø cm 40x50h | 7FR169 ø cm 60x40h Base: OPM17 bronze metal Top: OPP3 Emperador brown marble **CLIP side table** 7CL118 ø cm 40x50h OPM16 shiny brass chrome metal



FRAME side tables 7FR166 \varnothing cm 40x50h | 7FR169 \varnothing cm 60x40h Base: OPM17 bronze metal Top: OPP3 Emperador brown marble



PARKER bed 5PAR102 cm 205x220x113 Fabric: cat. H art. Dedar Belsuede col. 005 **Cushions:** 2 x 9ROL101 ø cm 10x58h Fabric: cat. H art. Casamance Manade B4248 18 36 | 1 x 9CU107 cm 25x50 Fabric: cat. H art. Casamance Lanata 4454 09 60 | 1 x 9CU106 cm 45x45 Fabric: cat. Manade B4248 29 13 Camel **PARIS footstools** with covered base 9PAR105X cm 41x31x50h | 9PAR106X cm 53x40x50h Fabric: cat. H art. Sahco Avalon 2 col. 50 **CLIPPER armchairs** 9CLX105 cm 70x76x75h Outer side: Leather cat. Lusso art. Nabuk marrone Inner side: Fabric cat. H art. Casamance Madame B4248 43 63 **FRAME side tables** 7FR166 ø cm 40x50h | 7FR169 ø cm 60x40h Base: OPM17 bronze metal Top: OPP3 Emperador brown marble **CLIP side table** 7CL118 ø cm 40x50h OPM16 shiny brass chrome metal







NOAH bed 5NOA102 cm 235x230x115h Fabric: cat. B/C art. Koala col. 120 **Cushions:** 2 x 9CU106 cm 45x45 Fabric: cat. F/G art. Misia Aime col. M188 613 Seychelles | 1 x 9CU106 cm 45x45 Fabric: cat. Manade B4248 29 13 Camel | 1 X 9CU107 cm 25x50 Fabric: cat. H art. Casamance Paddington 4857 04 94 | 1 x 9CU106 cm 45x45 Fabric: cat. H art. Casamance Tamise 4853 04 16 **SIGN armchair** 9SI112 cm 83x75x75h Fabric: cat. F/G art. Misia Aime col. M188 613 Seychelles Base: OPM16 shiny brass chrome metal **ARTHUR side table** 7ART201 ø cm 50x50h Base: OPM20 Delabré brass brushed metal Top: OPP7 Calacatta marble



ARTHUR side table 7ART201 ø cm 50x50h Base: OPM20 Delabré brass brushed metal Top: OPP7 Calacatta marble



NOAH bed 5NOA102 cm 235x230x115h Fabric: cat. B/C art. Koala col. 120 **Cushions:** 1 x 9CU106 cm 45x45 Fabric: cat. Manade B4248 29 13 Camel | 1 X 9CU107 cm 25x50 Fabric: cat. H art. Casamance Paddington 4857 04 94 | 1 x 9CU106 cm 45x45 Fabric: cat. H art. Casamance Tamise 4853 04 16 **SIGN armchair** 9SI112 cm 83x75x75h Fabric: cat. F/G art. Misia Aime col. M188 613 Seychelles Base: OPM16 shiny brass chrome metal **ARTHUR side table** 7ART201 ø cm 50x50h Base: OPM20 Delabré brass brushed metal Top: OPP7 Calacatta marble



SIGN armchair 9SI112 cm 83x75x75h Fabric: cat. F/G art. Misia Aime col. M188 613 Seychelles Base: OPM16 shiny brass chrome metal





BRANDON QUILTED bed with storage base 5BRQ202 cm 190x215x101h Leather: cat. Lusso art. Nabuk C3416 Marmotta **Cushions:** 1 x 9CU106 cm 45x45 Fabric: cat. H art. Casamance Lucy 5027 06 74 Ardoise | 1 x 9CU106 cm 45x45 Fabric: cat. H art. Casamance Uroko 4822 03 18 | 1 x 9CU106 cm 45x45 Fabric: cat. H art. Casamance Uroko 4822 06 62 **SIGN armchairs** 9SI112 cm 83x75x75h Fabric: cat. D/E art. Ostellato col. 20 Base: OPM15 antique gold brushed metal **PARIS stool and bench** 9PAR106 cm 53x40x50h | 9PAR107 cm 130x40x50h Fabric: cat. H art. Dedar Elektra T20027/016 Bleu Horizon Base: OPR15 moka matt stained oak **BREAK side tables** 7BR117 cm 40x45h Base: OPM17 bronze metal Top: OPV12 Transparent bronze glass | 7BR102 ø cm 60x36h Base: OPM17 bronze metal Top: OPP10 Black and Gold marble





BREAK side tables 7BR117 \varnothing cm 40x45h Base: OPM17 bronze metal Top: OPV12 Transparent bronze glass | 7BR102 \varnothing cm 60x36h Base: OPM17 bronze metal Top: OPP10 Black and Gold marble



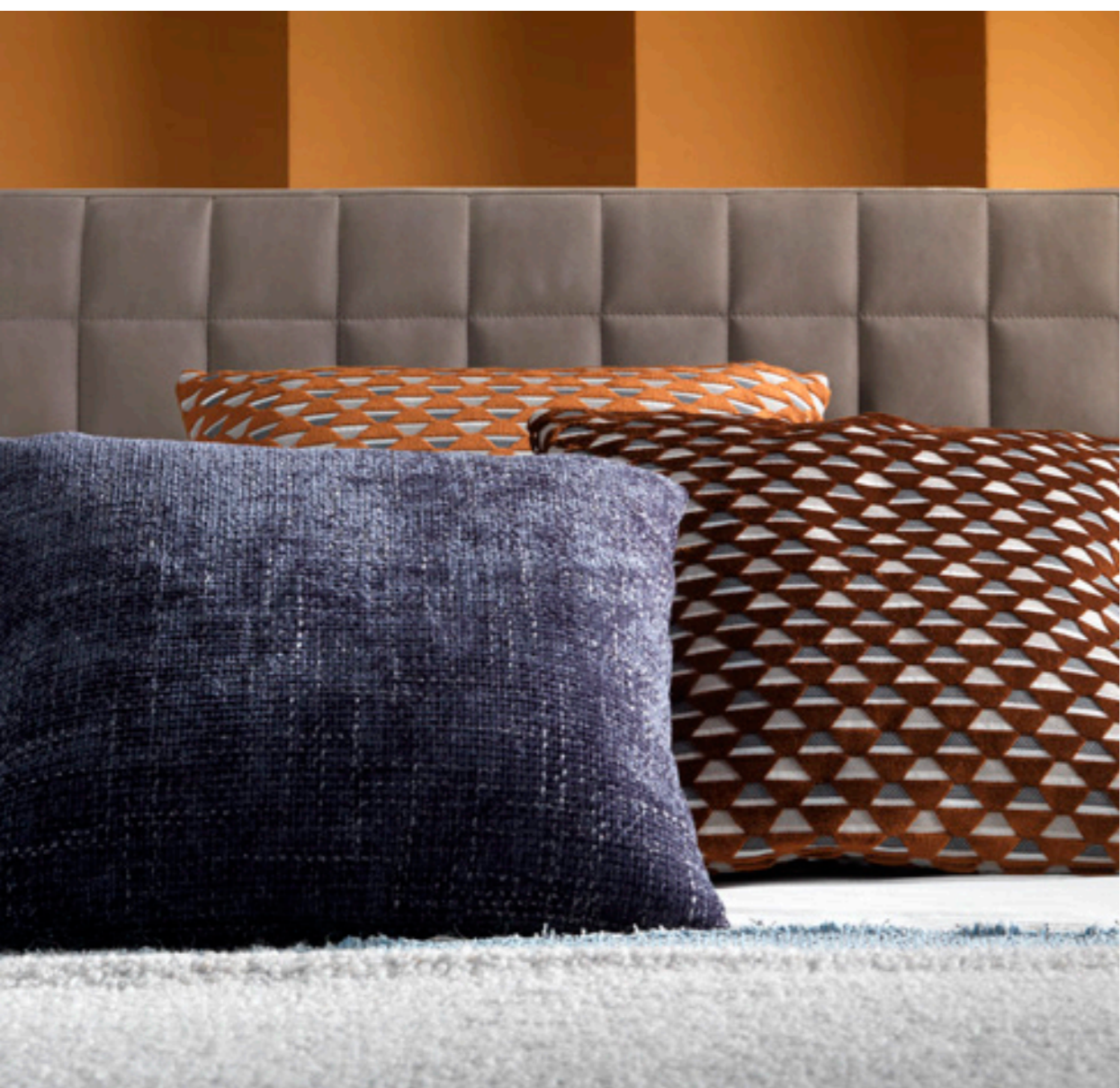



BRANDON bed 5BRA102 cm 190x215x101h Fabric: cat. D/E art. Lucinasco col. 02 **Cushions:** 2 x 9CU103 cm 40x40 Fabric: cat. H art. Designers Guild Glenville F1872 50 Orchid | 2 x roller cushions 9ROL101 ø cm 10x58 Fabric: cat. H art. Casamance Manade B4248 18 36 | 1 x 9CU106 cm 45x45 Fabric: cat. F/G art. Misia Aime col. M188 420 Cuivre **TWIG side table** 7TG101 ø cm 50x50h Base: OPM15 antique gold brushed metal Top: OPP7 Calacatta marble **SIGN armchairs** 9SI112 cm 83x75x75h Fabric: cat. H art. Designers Guild Glenville F1872 50 Orchid Base: OPM16 shiny brass chrome metal



TWIG side table 7TG101 ø cm 50x50h Base: OPM15 antique gold brushed metal Top: OPP7 Calacatta marble



TWIG side table 7TG101 ø cm 50x50h Base: OPM15 antique gold brushed metal Top: OPP7 Calacatta marble



BRANDON bed 5BRA102 cm 190x215x101h Fabric: cat. D/E art. Lucinasco col. 02 **Cushions:** 2 x 9CU103 cm 40x40 Fabric: cat. H art. Designers Guild Glenville F1872 50 Orchid | 2 x roller cushions 9ROL101 ø cm 10x58 Fabric: cat. H art. Casamance Manade B4248 18 36 | 1 x 9CU106 cm 45x45 Fabric: cat. F/G art. Misia Aime col. M188 420 Cuivre **TWIG side table** 7TG101 ø cm 50x50h Base: OPM15 antique gold brushed metal Top: OPP7 Calacatta marble **SIGN armchairs** 9SI112 cm 83x75x75h Fabric: cat. H art. Designers Guild Glenville F1872 50 Orchid Base: OPM16 shiny brass chrome metal



SIGN armchair 9S1112 cm 83x75x75h Fabric: cat. H art. Designers Guild Glenville F1872 50 Orchid Base: OPM16 shiny brass chrome metal **CLIP side table** 7CL117
ø cm 40x40h OPM16 shiny brass chrome metal



NOLAN bed 5NOL102 cm 190x230x133h Fabric: cat. H art. Dedar Belsuede col. 038 **Cushions:** 1 x 9CU107 cm 25x50 Fabric: cat. H art. Dedar Belsuede col. 038 | 1 x 9CU106 cm 45x45 Fabric: cat. H art. Rubelli Spritz col. 11 Ambra | 2 x 9CU106 cm 45x45 Fabric: cat. H art. Designers Guild Glenville F1872 50 Orchid | 1 x 9CU103 cm 40x40 | 1 x 9CU106 cm 45x45 Fabric: cat. H art. Misia La Flèche d'Or M260 7 01 col. 01 Seppia **PARIS stool** 9PAR106 cm 53x40x50h Fabric: Cat. H art. Rubelli Spritz col. 24 Reseda Base: OPR15 moka matt stained oak **ATENE side table** 7AT102 ø cm 50x50h Base: OPM16 shiny brass chrome metal Top: OPP21 Calacatta violet marble **NEST armchair** 9NE101 cm 73x80x90h Fabric: cat. H art. Rubelli Spritz col. 11 Ambra Base: OPM15 antique gold brushed metal



ATENE side table 7AT102 ø cm 50x50h Base: OPM16 shiny brass chrome metal Top: OPP21 Calacatta violet marble



NOLAN bed 5NOL102 cm 190x230x133h Fabric: cat. H art. Dedar Belsuede col. 038 **Cushions:** 1 x 9CU107 cm 25x50 Fabric: cat. H art. Dedar Belsuede col. 038 | 1 x 9CU106 cm 45x45 Fabric: cat. H art. Rubelli Spritz col. 11 Ambra | 2 x 9CU106 cm 45x45 Fabric: cat. H art. Designers Guild Glenville F1872 50 Orchid | 1 x 9CU103 cm 40x40 | 1 x 9CU106 cm 45x45 Fabric: cat. H art. Misia La Flèche d'Or M260 7 01 col. 01 Seppia **PARIS stool** 9PAR106 cm 53x40x50h Fabric: Cat. H art. Rubelli Spritz col. 24 Reseda Base: OPR15 moka matt stained oak **ATENE side table** 7AT102 ø cm 50x50h Base: OPM16 shiny brass chrome metal Top: OPP21 Calacatta violet marble **NEST armchair** 9NE101 cm 73x80x90h Fabric: cat. H art. Rubelli Spritz col. 11 Ambra Base: OPM15 antique gold brushed metal



NOLAN bed 5NOL102 cm 190x230x133h Fabric: cat. H art. Dedar Belsuede col. 038 **Cushions:** 1 x 9CU107 cm 25x50 Fabric: cat. H art. Dedar Belsuede col. 038 | 1 x 9CU106 cm 45x45 Fabric: cat. H art. Rubelli Spritz col. 11 Ambra | 2 x 9CU106 cm 45x45 Fabric: cat. H art. Designers Guild Glenville F1872 50 Orchid | 1 x 9CU103 cm 40x40 | 1 x 9CU106 cm 45x45 Fabric: cat. H art. Misia La Flèche d'Or M260 7 01 col. 01 Seppia **PARIS stool** 9PAR106 cm 53x40x50h | 9PAR105 cm 41x31x50h Fabric: Cat. H art. Rubelli Spritz col. 24 Reseda Base: OPR15 moka matt stained oak **ATENE side table** 7AT102 ø cm 50x50h Base: OPM16 shiny brass chrome metal Top: OPP21 Calacatta violet marble





NEST armchair 9NE101 cm 73x80x90h Fabric: cat. H art. Rubelli Spritz col. 11 Ambra Base: OPM15 antique gold brushed metal

Nolan Classic

DESIGN
STUDIO MARELLI
2022

90

91

BED AND SOFA BED COLLECTION 2023 _ MARELLI



NOLAN CLASSIC bed with storage base 5NOC202 cm 190x230x133h Fabric: cat. F/G art. Misia Aime M188 622 Badiane **Cushions:** 1 x 9CU107 cm 25x50 | 1 x 9CU106 cm 45x45 Fabric: cat. H art. Casamance Lanata 4454 09 60 | 2 x roller cushions 9ROL101 Fabric: cat. H art. Casamance Manade B4248 43 63 **PARIS bench** 9PAR107 cm 130x40x50h Fabric: cat. F/G art. Misia Aime M188 622 Badiane Base: OPR15 moka matt stained oak **BRERA armchair** with high back 9BRE105 cm 80x82x101h Fabric: cat. F/G art. Misia Aime M188 512 blue turquin Base: OPR15 moka matt stained oak **BREAK side table** 7BR102 ø cm 60x36h Top: OPP10 Black and Gold marble Base: OPM17 bronze metal **CLIP side table** 7CL118 ø cm 40x50h OPM17 bronze metal

marelli





PARIS footstool 9PAR105 cm 41x31x50h Fabric: cat. F/G art. Casamance Interview 3691 05 41 Base: OPR11 Charcoal stained oak **PARIS footstools** 9PAR105 cm 41x31x50h | 9PAR106 cm 53x40x50h Fabric: cat. H art. Dedar Elektra T20027/016 Bleu Horizon Base: OPR15 moka matt stained oak **PARIS footstools** 9PAR105 cm 41x31x50h | 9PAR106 cm 53x40x50h Fabric: cat. H art. Spritz Reseda 24 Base: OPR15 moka matt stained oak **PARIS footstools** 9PAR105X cm 41x31x50h | 9PAR106X cm 53x40x50h Fabric: cat. H art. Avalon 2 col. 050 Base covered in the same fabric **PARIS footstool** 9PAR107 cm 130x40x50h Fabric: cat. F/G art. Misia Aime M188 622 Badiane Base: OPR15 moka matt stained oak





BRERA armchair with high back 9BRE105 cm 80x82x101h Fabric: cat. F/G art. Misia Aime M188 512 blue turquin Base: OPR15 moka matt stained oak **PARIS bench** 9PAR107 cm 130x40x50h Fabric: cat. F/G art. Misia Aime M188 622 Badiane Base: OPR15 moka matt stained oak

Divani letto

SOFA BEDS



ADAM sofa bed 9ADM202 cm 195x96x81h Fabric: cat. D/E art. Lucinasco col. 22 **Cushions** 9CU105 cm 50x50 Fabric: cat. H art. Casamance Uroko 4822 03 18 | 9CU107 cm 25x50 Fabric: cat. H art. Casamance Lanata 4454 09 60 **ELLE side tables** 7EL107 cm 50x50x43h OPM15 antique gold brushed metal | 7EL206 cm 60x60x27h Base: OPM15 antique gold brushed metal Top: OPP3 Emperador brown marble **THOR side table** 7TH104 cm 50x50x50h OPP3 Emperador brown marble

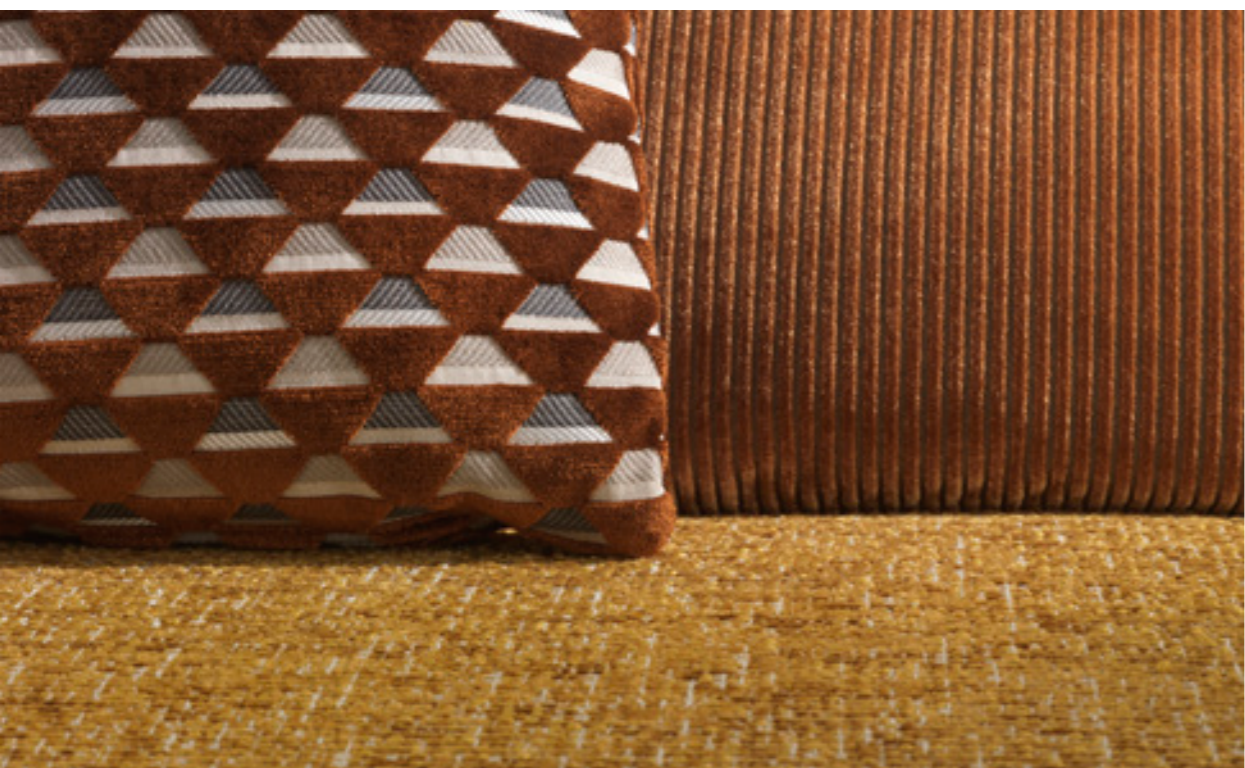

ADAM sofabed 9ADM202 cm 195x96x81h Fabric: cat. D/E art. Lucinasco col. 22 **Cushions** 9CU105 cm 50x50 Fabric: cat. H art. Casamance Uroko 4822 03 18 | 9CU107 cm 25x50 Fabric: cat. H art. Casamance Lanata 4454 09 60 **THOR side table** 7TH104 cm 50x50x50h OPP3 Emperador brown marble



ADAM sofa bed 9ADM202 cm 195x96x81h Fabric: cat. D/E art. Lucinasco col. 22 **Cushions** 9CU105 cm 50x50 Fabric: cat. H art. Casamance Uroko 4822 03 18 | 9CU107 cm 25x50 Fabric: cat. H art. Casamance Lanata 4454 09 60 **ELLE side tables** 7EL107 cm 50x50x43h OPM15 antique gold brushed metal | 7EL206 cm 60x60x27h Base: OPM15 antique gold brushed metal Top: OPP3 Emperador brown marble **THOR side table** 7TH104 cm 50x50x50h OPP3 Emperador brown marble





DEMON sofabed 9DEM202 cm 226x98x81h Fabric: cat. G art. Kieffer by Rubelli Velours Soleil 17189 012 Mastic **Cushions:** 2 x 9CU106 cm 45x45 Fabric: cat. F/G art. Misià Aime col. M188 420 Cuivre **RIVER ottoman** 9RIV102 ø cm 80x35h Fabric: cat. H art. Casamance Manade 4248 1836 Bois de Rose **DUNE side tables** 7DU101 ø cm 40x42h | 7DU102 ø cm 40x52h Base: OPR15 moka matt stained oak Top: OPP7 Calacatta marble



DEMON sofabed 9DEM202 cm 226x98x81h Fabric: cat. G art. Kieffer by Rubelli Velours Soleil 17189 012 Mastic **Cushions:** 1 x 9ROL101 ø cm 10x58 Fabric: cat. H art. Casamance Manade B4248 18 36 Bois de Rose | 1 x 9CU106 cm 45x45 | 1 x 9CU107 cm 25x50 Fabric: cat. H art. Casamance Lanata 4454 09 60 **RIVER ottoman** 9RIV102 ø cm 80x35h Fabric: cat. H art. Casamance Manade 4248 1836 Bois de Rose **DUNE side tables** 7DU101 ø cm 40x42h | 7DU102 ø cm 40x52h Base: OPR15 moka matt stained oak Top: OPP7 Calacatta marble







KENDALL sofabed 9KEN202 cm 228x92x82h Fabric: cat. B/C art. Koala 120 **Cushions:** 9CU106 cm 45x45 Fabric: cat. F/G art. Misia Aime M188 613 Seychelles | 9CU107 cm 25x50 Fabric: cat. H art. Casamance Paddington 4857 04 94 **MOON ottoman** 9MN102 ø 60x40h Fabric: cat. H art. Casamance Paddington 4857 04 94
Base: OPM15 antique gold brushed metal **CLIP side table** 7CL118 ø cm 40x50h OPM15 antique gold brushed metal



KENDALL sofabed 9KEN202 cm 228x92x82h Fabric: cat. B/C art. Koala 120 **Cushions:** 9CU106 cm 45x45 Fabric: cat. F/G art. Misia Aime M188 613 Seychelles | 9CU107 cm 25x50 Fabric: cat. H art. Casamance Paddington 4857 04 94 **MOON ottoman** 9MN102 ø 60x40h Fabric: cat. H art. Casamance Paddington 4857 04 94 Base: OPM15 antique gold brushed metal **CLIP side table** 7CL118 ø cm 40x50h OPM15 antique gold brushed metal







KENDALL composition cm 301x224 made of: 1 x sofa bed with one left armrest 9KEN302 cm 206x92x72h | 1 x right chaise longue 9KEN205 cm 95x224x82h Fabric: cat. D/E art. Clusone col. 12 **Cushions:** 1 x 9KEN102 cm 47x26 Fabric: cat. D/E art. Clusone col. 12 | 1 x 9CU106 cm 45x45 | 1 x 9CU107 cm 25x50 Fabric: cat. H art. Casamance Tamise 485 304 16 | 1 x 9CU106 cm 45x45 Fabric: cat. H art. Casamance Lucy 502 706 74 ardoise | 2 x 9CU106 cm 45x45 Fabric: cat. F/G art. Misia Aime M188 613 Seychelles **WAVE coffee table** 7WA103 ø cm 100x27h Base: OPM20 Delabré brass brushed metal Top: OPP7 Calacatta marble **THOR side table** 7TH115 cm 60x60x27h OPP15 Covelano white marble Base: OPM9 classic bronze painted metal



KENDALL composition cm 301x224 made of: 1 x sofabed with one left armrest 9KEN302 cm 206x92x72h | 1 x right chaise longue 9KEN205 cm 95x224x82h Fabric: cat. D/E art. Clusone col. 12 **Cushions:** 1 x 9KEN102 cm 47x26 Fabric: cat. D/E art. Clusone col. 12 | 1 x 9CU106 cm 45x45 | 1 x 9CU107 cm 25x50 Fabric: cat. H art. Casamance Tamise 485 304 16 | 1 x 9CU106 cm 45x45 Fabric: cat. H art. Casamance Lucy 502 706 74 ardoise | 2 x 9CU106 cm 45x45 Fabric: cat. F/G art. Misia Aime M188 613 Seychelles **WAVE coffee table** 7WA103 ø cm 100x27h Base: OPM20 Delabré brass brushed metal Top: OPP7 Calacatta marble **THOR side table** 7TH115 cm 60x60x27h OPP15 Covelano white marble Base: OPM9 classic bronze painted metal



KENDALL composition cm 301x224 made of: 1 x sofa bed with one left armrest 9KEN302 cm 206x92x72h | 1 x right chaise longue 9KEN205 cm 95x224x82h Fabric: cat. D/E art. Clusone col. 12 **Cushions:** 1 x 9KEN102 cm 47x26 Fabric: cat. D/E art. Clusone col. 12 | 1 x 9CU106 cm 45x45 | 1 x 9CU107 cm 25x50 Fabric: cat. H art. Casamance Tamise 485 304 16 | 1 x 9CU106 cm 45x45 Fabric: cat. H art. Casamance Lucy 502 706 74 ardoise | 2 x 9CU106 cm 45x45 Fabric: cat. F/G art. Misia Aime M188 613 Seychelles **THOR side table** 7TH115 cm 60x60x27h OPP15 Covelano white marble Base: OPM9 classic bronze painted metal





LOGAN sofabed 9LOG202 cm 224x92x81h Fabric: cat. H art. Sahco Zero col. 012 **Cushions:** 9CU106 cm 45x45 Fabric: cat. F art. Misia Aime M188 622 Badiane | 9CU106 cm 45x45 | 9CU107 cm 25x50 Fabric: cat. H art. Casamance Lanata 4454 09 60 **ELLE side tables:** 7EL108 cm 40x40x57h | 7EL107 cm 50x50x43h OPM16 shiny brass chrome metal | 7EL206 cm 60x60x27h Base: OPM16 shiny brass chrome metal Top: OPP3 Emperador brown marble









LOGAN sofabed 9LOG202 cm 224x92x81h Fabric: cat. H art. Sahco Zero col. 012 **Cushions:** 9CU106 cm 45x45 Fabric: cat. F art. Misia Aime M188 622 Badiane | 9CU106 cm 45x45 | 9CU107 cm 25x50 Fabric: cat. H art. Casamance Lanata 4454 09 60 **ELLE side tables:** 7EL108 cm 40x40x57h shiny brass chrome metal



LUCAS sofabed 9LUC202 cm 218x103x80h Fabric: cat. H art. Rubelli Spritz Reseda col. 24 **Cushions:** 9CU107 cm 25x50 Fabric: cat. H art. Casamance Manade 4248 2913 Camel | 9CU103 cm 40x40 9CU106 cm 45x45 Fabric: cat. H art. Misia La Flèche d'Or M260 7 01 col. 01 Seppia **CLIP side tables:** 7CL118 ø cm 40x45h OPM16 shiny brass chrome metal | 7CL116 ø cm 60x27h OPM15 antique gold brushed metal **WAVE side table** 7WA102 ø cm 50x47h Base: OPM20 Delabré brass brushed metal Top: OPP7 Calacatta marble



LUCAS sofabed 9LUC202 cm 218x103x80h Fabric: cat. H art. Rubelli Spritz Reseda col. 24 **Cushions:** 9CU107 cm 25x50 Fabric: cat. H art. Casamance Manade 4248 2913 Camel | 9CU103 cm 40x40 9CU106 cm 45x45 Fabric: cat. H art. Misia La Flèche d'Or M260 7 01 col. 01 Seppia **CLIP side tables:** 7CL118 ø cm 40x45h OPM16 shiny brass chrome metal | 7CL116 ø cm 60x27h OPM15 antique gold brushed metal **WAVE side table** 7WA102 ø cm 50x47h Base: OPM20 Delabré brass brushed metal Top: OPP7 Calacatta marble



LUCAS sofabed 9LUC202 cm 218x103x80h Fabric: cat. H art. Rubelli Spritz Reseda col. 24 **Cushions:** 1 x 9CU107 cm 25x50 | 1 x 9CU106 cm 45x45 Fabric: cat. H art. Casamance Manade 4248 2913 Camel | 1 x 9CU106 cm 45x45 Fabric: cat. H art. Misia La Flèche d'Or M260 7 01 col. 01 Seppia **CLIP side table:** 7CL116 ø cm 60x27h OPM15 antique gold brushed metal **WAVE side table** 7WA102 ø cm 50x47h Base: OPM20 Delabré brass brushed metal Top: OPP7 Calacatta marble



Schede tecniche

TECHNICAL INFORMATION

Letti
BEDS

marelli











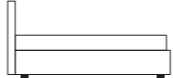
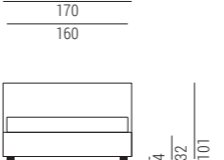
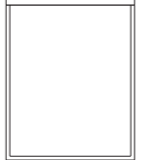

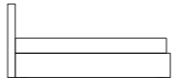
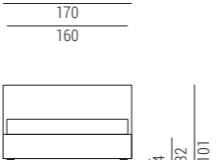
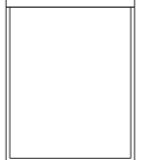
Struttura costituita da pannelli composti da particelle di legno, principalmente pioppo e abete.
Imbottitura in poliuretano indeformabile rivestito in dacron.
Rete con struttura in tubo di ferro e doghe in faggio.
Disponibile in tre diverse larghezze, anche con vano contenitore sotto la rete del letto.
Rivestimento sfoderabile in tessuto, non sfoderabile in pelle e finta pelle.

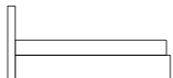
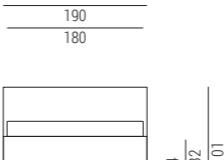
Structure consisting of panels composed of wood particles, mainly poplar and fir. Padding in non-deformable polyurethane covered in dacron. Bed base with structure in iron tube and beech slats. Available in three different widths, also with storage compartment under the bed base. Removable cover in fabric, non-removable in leather and artificial leather.

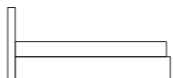
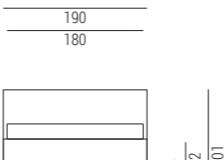

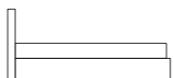
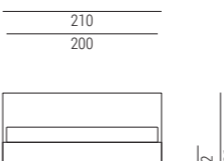
Struktur bestehend aus Platten aus Holzpartikeln, hauptsächlich Pappel und Tanne. Polsterung aus unverformbarem, mit Dacron überzogenem Polyurethan. Lattenrost mit Struktur aus Eisenrohr und Buchenlatten. Erhältlich in drei verschiedenen Breiten, auch mit Bettkasten unter dem Lattenrost. Abnehmbarer Bezug aus Stoff, nicht abziehbar aus Leder und Kunstleder.

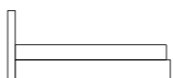
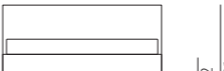
Structure composée de panneaux composés de particules de bois, principalement de peuplier et de sapin. Rembourrage en polyuréthane indéformable recouvert de dacron. Sommier avec structure en tube de fer et lattes de hêtre. Disponible en trois largeurs différentes, également avec compartiment de rangement sous le sommier. Revêtement déhoussable en tissu, non déhoussable en cuir et simili cuir.

Letti Beds

				Rete a doghe e materasso Slatted bed base and mattress L160 P200
SBRA101 L170 P215 H101				
				Rete a doghe e materasso Slatted bed base and mattress L160 P200
SBRA201 L170 P215 H101 Con contenitore With storage base				
				Rete a doghe e materasso Slatted bed base and mattress L180 P200
SBRA102 L190 P215 H101				
				Rete a doghe e materasso Slatted bed base and mattress L180 P200
SBRA202 L190 P215 H101 Con contenitore With storage base				
				Rete a doghe e materasso Slatted bed base and mattress L200 P200
SBRA103 L210 P215 H101				
				Rete a doghe e materasso Slatted bed base and mattress L200 P200
SBRA203 L210 P215 H101 Con contenitore With storage base				

Cuscini Cushions

	9ROL101 ø10 L58 Cuscino a rullo Roller cushion
	9CU103 L40 P40 Cuscinetto in piuma senza fascia Feather cushion without band
	9CU106 L45 P45 Cuscinetto in piuma senza fascia Feather cushion without band

Brandon Quilted

DESIGN
STUDIO MARELLI
2022

154

BED AND SOFA BED COLLECTION 2023 _ MARELLI

Struttura costituita da pannelli composti da particelle di legno, principalmente pioppo e abete.
Imbottitura in poliuretano indeformabile rivestito in dacron.
Rete con struttura in tubo di ferro e doghe in faggio.
Disponibile in tre diverse larghezze, anche con vano contenitore sotto la rete del letto.
Testata caratterizzata da trapuntatura a quadri, rivestimento sempre fisso, non sfoderabile.

Structure consisting of panels composed of wood particles, mainly poplar and fir. Padding in non-deformable polyurethane covered in dacron. Bed base with structure in iron tube and beech slats. Available in three different widths, also with storage compartment under the bed base. The headboard is characterized by the square-shaped quilting, covers are always fixed, non-removable.

Struktur bestehend aus Platten aus Holzpartikeln, hauptsächlich Pappel und Tanne. Polsterung aus unverformbarem, mit Dacron überzogenem Polyurethan. Lattenrost mit Struktur aus Eisenrohr und Buchenlatten. Erhältlich in drei verschiedenen Breiten, auch mit Bettkasten unter dem Lattenrost. Der Bettkopf zeichnet sich aus durch die Quadrat-Steppung. Bezüge sind immer fix, nicht abziehbar.

Structure composée de panneaux composés de particules de bois, principalement de peuplier et de sapin. Rembourrage en polyuréthane indéformable recouvert de dacron. Sommier avec structure en tube de fer et lattes de hêtre. Disponible en trois largeurs différentes, également avec compartiment de rangement sous le sommier. Tête de lit caractérisée par un matelassage carré, revêtement toujours fixe, non déhoussable.





Brandon Quilted

DESIGN
STUDIO MARELLI
2022

155

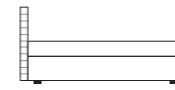
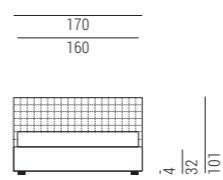
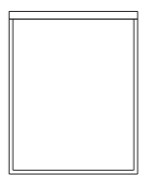
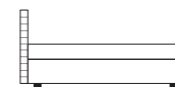
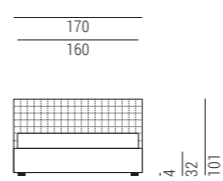
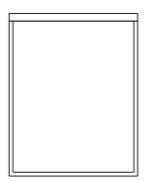
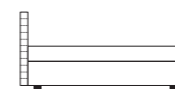
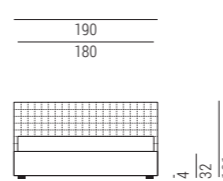
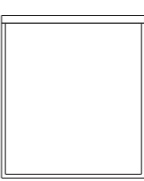
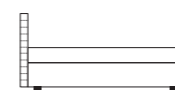
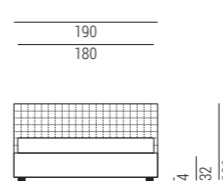
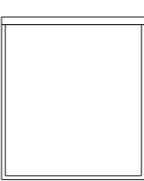
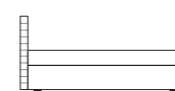
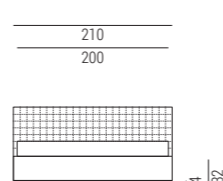
BED AND SOFA BED COLLECTION 2023 _ MARELLI

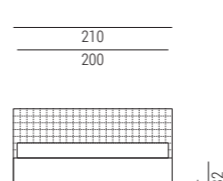
Letti Beds

			215	Rete a doghe e materasso Slatted bed base and mattress L160 P200
5BRQ101 L170 P215 H101				
			215	Rete a doghe e materasso Slatted bed base and mattress L160 P200
5BRQ201 L170 P215 H101 Con contenitore With storage base				
			215	Rete a doghe e materasso Slatted bed base and mattress L180 P200
5BRQ102 L190 P215 H101				
			215	Rete a doghe e materasso Slatted bed base and mattress L180 P200
5BRQ202 L190 P215 H101 Con contenitore With storage base				
			215	Rete a doghe e materasso Slatted bed base and mattress L200 P200
5BRQ103 L210 P215 H101				
			215	Rete a doghe e materasso Slatted bed base and mattress L200 P200
5BRQ203 L210 P215 H101 Con contenitore With storage base				

Cuscini Cushions

9ROL101
ø10 L58
Cuscino a rullo
Roller cushion



9CU106
L45 P45
Cuscinetto in piuma senza fascia
Feather cushion without band



Struttura costituita da pannelli composti da particelle di legno, principalmente pioppo e abete.
Imbottitura in poliuretano indeformabile rivestito in dacron.
Rete con struttura in tubo di ferro e doghe in faggio.
Disponibile in tre diverse larghezze, con piedi in metallo.
Rivestimento sfoderabile in tessuto, non sfoderabile in pelle e finta pelle.

Structure consisting of panels composed of wood particles, mainly poplar and fir.
Padding in non-deformable polyurethane covered in dacron.
Bed base with structure in iron tube and beech slats.
Available in three different widths, with metal feet.
Removable cover in fabric, non-removable in leather and artificial leather.

Struktur bestehend aus Platten aus Holzpartikeln, hauptsächlich Pappel und Tanne.
Polsterung aus unverformbarem, mit Dacron überzogenem Polyurethan.
Lattenrost mit Struktur aus Eisenrohr und Buchenlatten.
Erhältlich in drei verschiedenen Breiten, mit Metallfüßen.
Abnehmbarer Bezug aus Stoff, nicht abziehbar aus Leder und Kunstleder.

Structure composée de panneaux composés de particules de bois, principalement de peuplier et de sapin.
Rembourrage en polyuréthane indéformable recouvert de dacron.
Sommier avec structure en tube de fer et lattes de hêtre.
Disponible en trois largeurs différentes, avec pieds en métal.
Revêtement déhoussable en tissu, non déhoussable en cuir et simili cuir.

Letti Beds

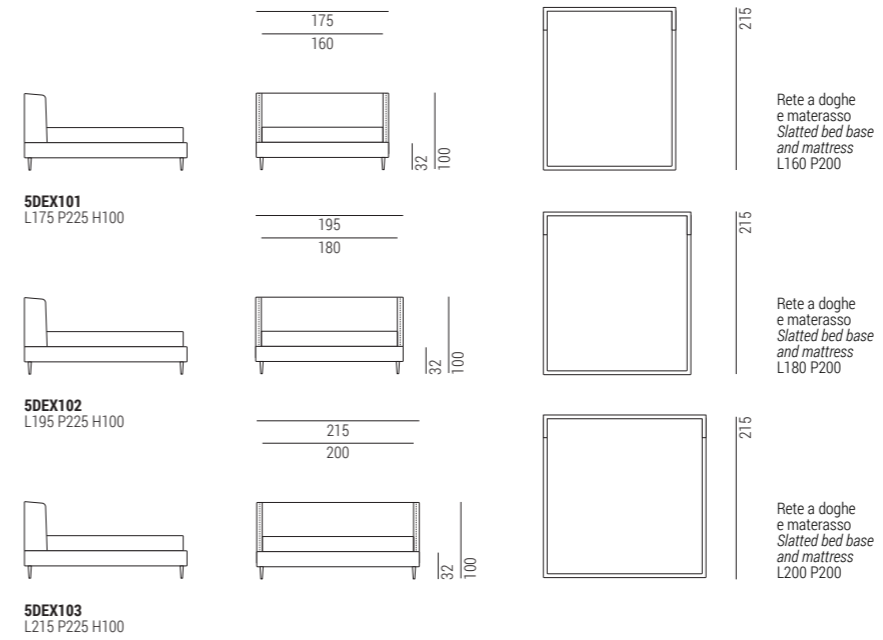

Cuscini Cushions



Base in metallo Metal base

Base in metallo
Metal Base



Dexter Box

DESIGN
STUDIO MARELLI
2022

158

BED AND SOFA BED COLLECTION 2023 _ MARELLI

Struttura costituita da pannelli composti da particelle di legno, principalmente pioppo e abete.
Imbottitura in poliuretano indeformabile rivestito in dacron.
Rete con struttura in tubo di ferro e doghe in faggio.
Disponibile in tre diverse larghezze, anche con vano contenitore sotto la rete del letto.
Rivestimento sfoderabile in tessuto, non sfoderabile in pelle e finta pelle.

Structure consisting of panels composed of wood particles, mainly poplar and fir. Padding in non-deformable polyurethane covered in dacron. Bed base with structure in iron tube and beech slats. Available in three different widths, also with storage compartment under the bed base. Removable cover in fabric, non-removable in leather and artificial leather.

Struktur bestehend aus Platten aus Holzpartikeln, hauptsächlich Pappel und Tanne. Polsterung aus unverformbarem, mit Dacron überzogenem Polyurethan. Lattenrost mit Struktur aus Eisenrohr und Buchenlatten. Erhältlich in drei verschiedenen Breiten, auch mit Bettkasten unter dem Lattenrost. Abnehmbarer Bezug aus Stoff, nicht abziehbar aus Leder und Kunstleder.

Structure composée de panneaux composés de particules de bois, principalement de peuplier et de sapin. Rembourrage en polyuréthane indéformable recouvert de dacron. Sommier avec structure en tube de fer et lattes de hêtre. Disponible en trois largeurs différentes, également avec compartiment de rangement sous le sommier. Revêtement déhoussable en tissu, non déhoussable en cuir et simili cuir.







Dexter Box

DESIGN
STUDIO MARELLI
2022

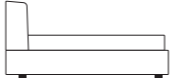
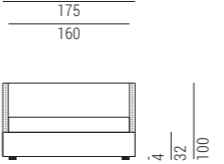
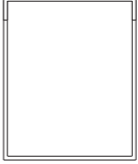
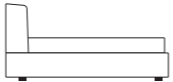
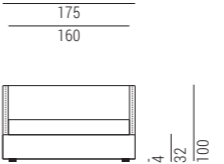
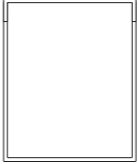
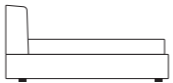
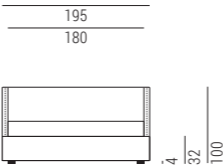
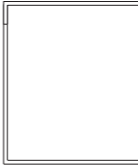
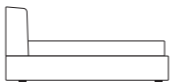
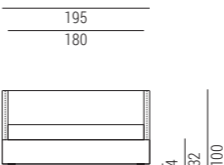

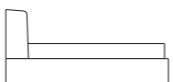
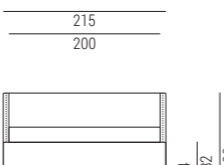
159

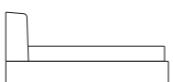
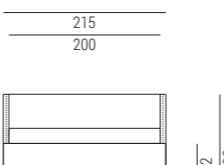
BED AND SOFA BED COLLECTION 2023 _ MARELLI

Letti Beds

			215	Rete a doghe e materasso Slatted bed base and mattress L160 P200
5DXB101 L175 P225 H100				
			215	Rete a doghe e materasso Slatted bed base and mattress L160 P200
5DXB201 L175 P225 H100 Con contenitore With storage base				
			215	Rete a doghe e materasso Slatted bed base and mattress L180 P200
5DXB102 L195 P225 H100				
			215	Rete a doghe e materasso Slatted bed base and mattress L180 P200
5DXB202 L195 P225 H100 Con contenitore With storage base				
			215	Rete a doghe e materasso Slatted bed base and mattress L200 P200
5DXB103 L215 P225 H100				
			215	Rete a doghe e materasso Slatted bed base and mattress L200 P200
5DXB203 L215 P225 H100 Con contenitore With storage base				

Cuscini Cushions

	9ROL101 ø10 L58 Cuscino a rullo Roller cushion
	9CU106 L45 P45 Cuscinetto in piuma senza fascia Feather cushion without band
	9CU107 L50 H25 Cuscinetto in piuma senza fascia Feather cushion without band

Struttura costituita da pannelli composti da particelle di legno, principalmente pioppo e abete.
Imbottitura in poliuretano indeformabile rivestito in dacron.
Rete con struttura in tubo di ferro e doghe in faggio.
Disponibile in tre diverse larghezze, anche con vano contenitore sotto la rete del letto.
Rivestimento sfoderabile in tessuto, non sfoderabile in pelle e finta pelle.

Structure consisting of panels composed of wood particles, mainly poplar and fir.
Padding in non-deformable polyurethane covered in dacron.
Bed base with structure in iron tube and beech slats.
Available in three different widths, also with storage compartment under the bed base.
Removable cover in fabric, non-removable in leather and artificial leather.

Struktur bestehend aus Platten aus Holzpartikeln, hauptsächlich Pappel und Tanne.
Polsterung aus unverformbarem, mit Dacron überzogenem Polyurethan.
Lattenrost mit Struktur aus Eisenrohr und Buchenlatten.
Erhältlich in drei verschiedenen Breiten, auch mit Bettkasten unter dem Lattenrost.
Abnehmbarer Bezug aus Stoff, nicht abziehbar aus Leder und Kunstleder.

Structure composée de panneaux composés de particules de bois, principalement de peuplier et de sapin.
Rembourrage en polyuréthane indéformable recouvert de dacron.
Sommier avec structure en tube de fer et lattes de hêtre.
Disponible en trois largeurs différentes, également avec compartiment de rangement sous le sommier.
Revêtement déhoussable en tissu, non déhoussable en cuir et simili cuir.

Letti Beds

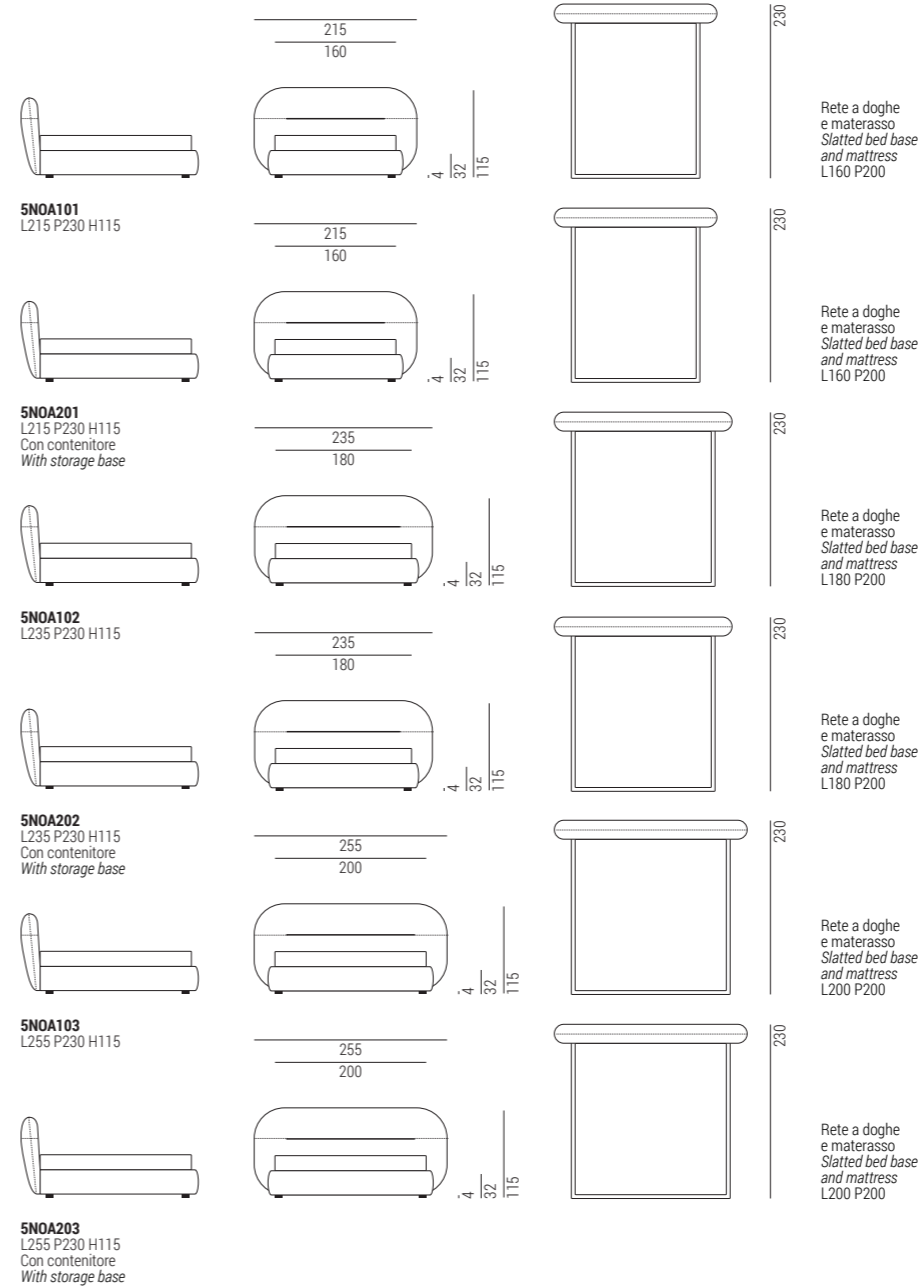

Cuscini Cushions











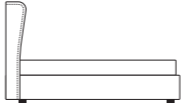
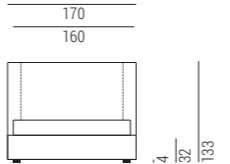
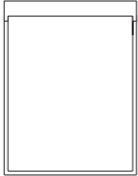
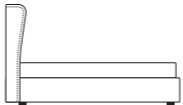
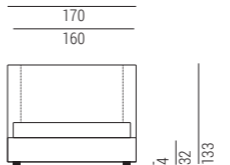

Struttura costituita da pannelli composti da particelle di legno, principalmente pioppo e abete.
Imbottitura in poliuretano indeformabile rivestito in dacron.
Rete con struttura in tubo di ferro e doghe in faggio.
Disponibile in tre diverse larghezze, anche con vano contenitore sotto la rete del letto.
Rivestimento sfoderabile in tessuto, non sfoderabile in pelle e finta pelle.

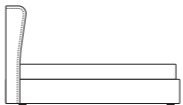
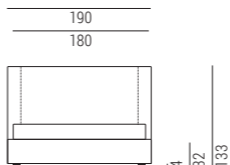
Structure consisting of panels composed of wood particles, mainly poplar and fir. Padding in non-deformable polyurethane covered in dacron. Bed base with structure in iron tube and beech slats. Available in three different widths, also with storage compartment under the bed base. Removable cover in fabric, non-removable in leather and artificial leather.

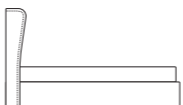
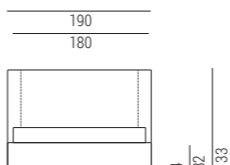

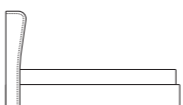
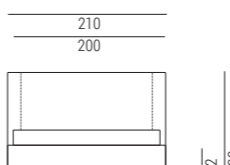
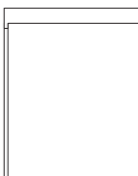
Struktur bestehend aus Platten aus Holzpartikeln, hauptsächlich Pappel und Tanne. Polsterung aus unverformbarem, mit Dacron überzogenem Polyurethan. Lattenrost mit Struktur aus Eisenrohr und Buchenlatten. Erhältlich in drei verschiedenen Breiten, auch mit Bettkasten unter dem Lattenrost. Abnehmbarer Bezug aus Stoff, nicht abziehbar aus Leder und Kunstleder.

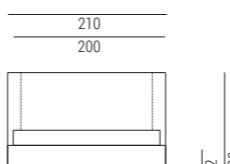
Structure composée de panneaux composés de particules de bois, principalement de peuplier et de sapin. Rembourrage en polyuréthane indéformable recouvert de dacron. Sommier avec structure en tube de fer et lattes de hêtre. Disponible en trois largeurs différentes, également avec compartiment de rangement sous le sommier. Revêtement déhoussable en tissu, non déhoussable en cuir et simili cuir.

Letti Beds

			215	Rete a doghe e materasso Slatted bed base and mattress L160 P200
5NOL101 L170 P230 H133				
			215	Rete a doghe e materasso Slatted bed base and mattress L160 P200
5NOL201 L170 P230 H133 Con contenitore With storage base				
			215	Rete a doghe e materasso Slatted bed base and mattress L180 P200
5NOL102 L190 P230 H133				
			215	Rete a doghe e materasso Slatted bed base and mattress L180 P200
5NOL202 L190 P230 H133 Con contenitore With storage base				
			215	Rete a doghe e materasso Slatted bed base and mattress L200 P200
5NOL103 L210 P230 H133				
			215	Rete a doghe e materasso Slatted bed base and mattress L200 P200
5NOL203 L210 P230 H133 Con contenitore With storage base				

Cuscini Cushions

	9ROL101 ø10 L58 Cuscino a rullo Roller cushion
	9CU103 L40 P40 Cuscinetto in piuma senza fascia Feather cushion without band
	9CU106 L45 P45 Cuscinetto in piuma senza fascia Feather cushion without band
	9CU107 L50 H25 Cuscinetto in piuma senza fascia Feather cushion without band

Struttura costituita da pannelli composti da particelle di legno, principalmente pioppo e abete.
Imbottitura in poliuretano indeformabile rivestito in dacron.
Rete con struttura in tubo di ferro e doghe in faggio.
Disponibile in tre diverse larghezze, anche con vano contenitore sotto la rete del letto.
Testata caratterizzata da lavorazione capitonné, rivestimento sempre fisso, non sfoderabile.

Structure consisting of panels composed of wood particles, mainly poplar and fir. Padding in non-deformable polyurethane covered in dacron. Bed base with structure in iron tube and beech slats. Available in three different widths, also with storage compartment under the bed base. The headboard is characterized by the capitonné finishing. Covers are always fixed, non-removable.

Struktur bestehend aus Platten aus Holzpartikeln, hauptsächlich Pappel und Tanne. Polsterung aus unverformbarem, mit Dacron überzogenem Polyurethan. Lattenrost mit Struktur aus Eisenrohr und Buchenlatten. Erhältlich in drei verschiedenen Breiten, auch mit Bettkasten unter dem Lattenrost. Der Bettkopf zeichnet sich aus durch die Capitonné-Verarbeitung. Bezüge sind immer fix, nicht abziehbar.

Structure composée de panneaux composés de particules de bois, principalement de peuplier et de sapin. Rembourrage en polyuréthane indéformable recouvert de dacron. Sommier avec structure en tube de fer et lattes de hêtre. Disponible en trois largeurs différentes, également avec compartiment de rangement sous le sommier. Tête de lit caractérisée par une finition capitonné. Revêtement toujours fixe, non déhoussable.

Letti Beds

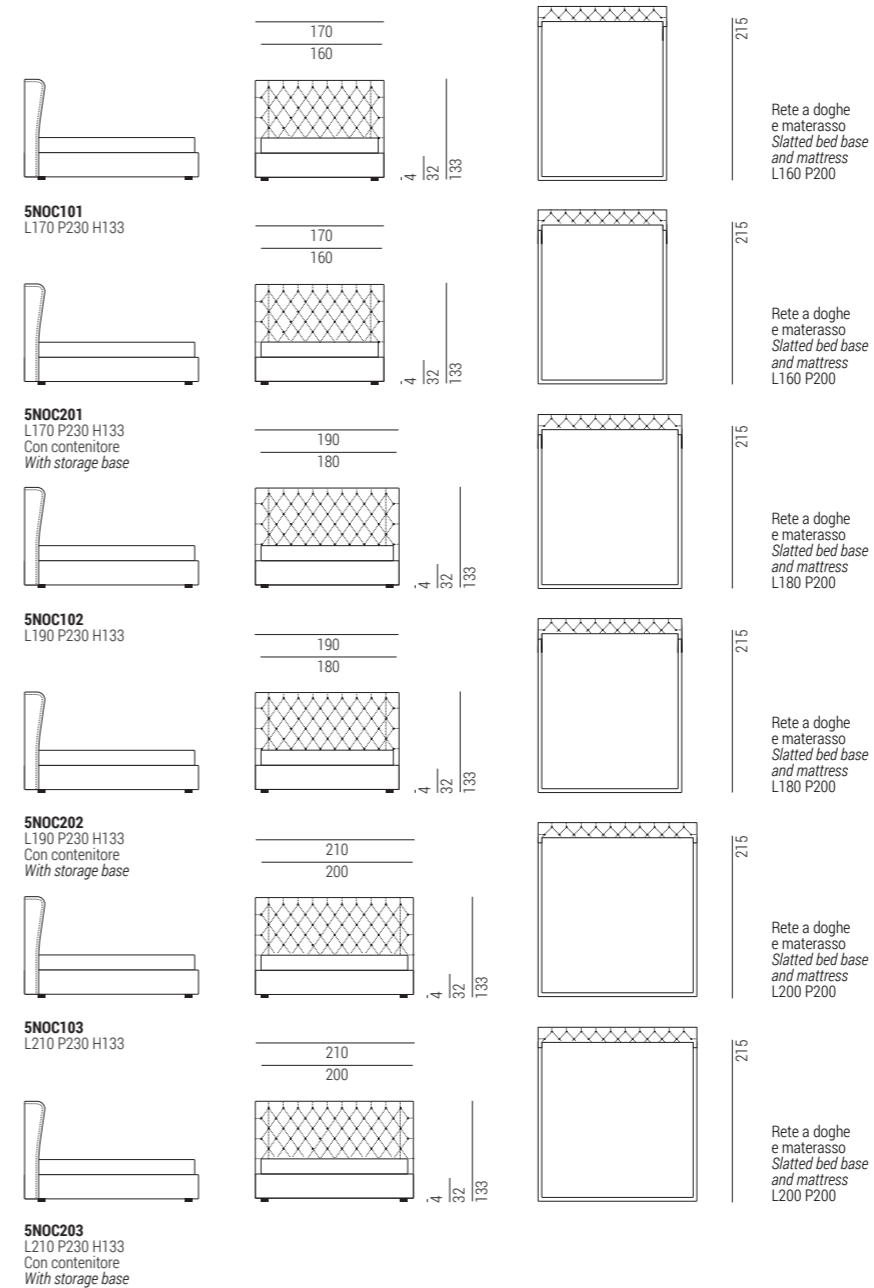

Cuscini Cushions

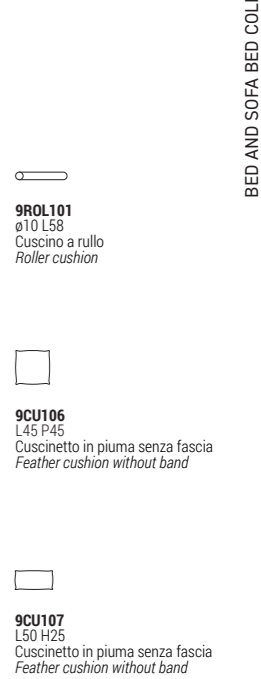











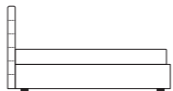
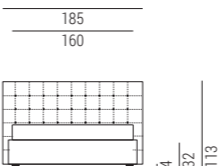
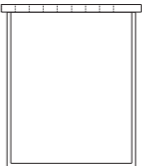

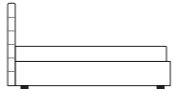
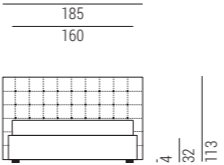
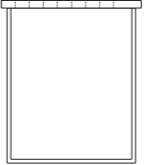
Struttura costituita da pannelli composti da particelle di legno, principalmente pioppo e abete.
Imbottitura in poliuretano indeformabile rivestito in dacron.
Rete con struttura in tubo di ferro e doghe in faggio.
Disponibile in tre diverse larghezze, anche con vano contenitore sotto la rete del letto.
Testata caratterizzata da trapuntatura, rivestimento sempre fisso, non sfoderabile.

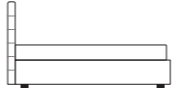
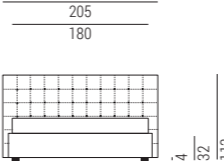
Structure consisting of panels composed of wood particles, mainly poplar and fir. Padding in non-deformable polyurethane covered in dacron. Bed base with structure in iron tube and beech slats. Available in three different widths, also with storage compartment under the bed base. The headboard is characterized by quilting, covers are always fixed, non-removable.

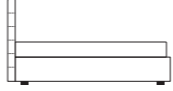
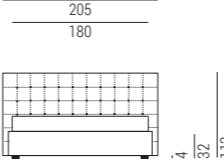

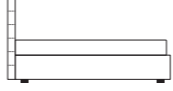
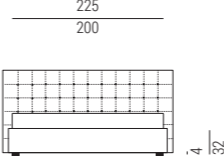
Struktur bestehend aus Platten aus Holzpartikeln, hauptsächlich Pappel und Tanne. Polsterung aus unverformbarem, mit Dacron überzogenem Polyurethan. Lattenrost mit Struktur aus Eisenrohr und Buchenlatten. Erhältlich in drei verschiedenen Breiten, auch mit Bettkasten unter dem Lattenrost. Der Bettkopf zeichnet sich aus durch die Steppung. Bezüge sind immer fix, nicht abziehbar.

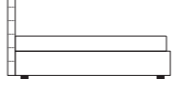
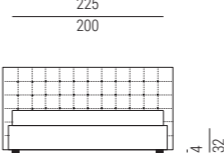
Structure composée de panneaux composés de particules de bois, principalement de peuplier et de sapin. Rembourrage en polyuréthane indéformable recouvert de dacron. Sommier avec structure en tube de fer et lattes de hêtre. Disponible en trois largeurs différentes, également avec compartiment de rangement sous le sommier. Tête de lit caractérisée par le matelassage, revêtement toujours fixe, non déhoussable.

Letti Beds

				Rete a doghe e materasso Slatted bed base and mattress L160 P200
SPAR101 L185 P220 H113				
				Rete a doghe e materasso Slatted bed base and mattress L160 P200
SPAR201 L185 P220 H113 Con contenitore With storage base				
				Rete a doghe e materasso Slatted bed base and mattress L180 P200
SPAR102 L205 P220 H113				
				Rete a doghe e materasso Slatted bed base and mattress L180 P200
SPAR202 L205 P220 H113 Con contenitore With storage base				
				Rete a doghe e materasso Slatted bed base and mattress L200 P200
SPAR103 L225 P220 H113				
				Rete a doghe e materasso Slatted bed base and mattress L200 P200
SPAR203 L225 P220 H113 Con contenitore With storage base				

Cuscini Cushions

	9ROL101 ø10 L58 Cuscino a rullo Roller cushion
	9CU106 L45 P45 Cuscinetto in piuma senza fascia Feather cushion without band
	9CU107 L50 H25 Cuscinetto in piuma senza fascia Feather cushion without band

Struttura costituita da pannelli composti da particelle di legno, principalmente pioppo e abete.
Imbottitura in poliuretano indeformabile rivestito in dacron.
Rete con struttura in tubo di ferro e doghe in faggio.
Disponibile in tre diverse larghezze, con base in metallo.
Rivestimento sfoderabile in tessuto, non sfoderabile in pelle e finta pelle.

*Structure consisting of panels composed of wood particles, mainly poplar and fir.
Padding in non-deformable polyurethane covered in dacron.
Bed base with structure in iron tube and beech slats.
Available in three different widths, with metal base.
Removable cover in fabric, non-removable in leather and artificial leather.*

*Struktur bestehend aus Platten aus Holzpartikeln, hauptsächlich Pappel und Tanne.
Polsterung aus unverformbarem, mit Dacron überzogenem Polyurethan.
Lattenrost mit Struktur aus Eisenrohr und Buchenlatten.
Erhältlich in drei verschiedenen Breiten, mit Metalluntergestell.
Abnehmbarer Bezug aus Stoff, nicht abziehbar aus Leder und Kunstleder.*

*Structure composée de panneaux composés de particules de bois, principalement de peuplier et de sapin.
Rembourrage en polyuréthane indéformable recouvert de dacron.
Sommier avec structure en tube de fer et lattes de hêtre.
Disponible en trois largeurs différentes, avec base en métal.
Revêtement déhoussable en tissu, non déhoussable en cuir et simili cuir.*

Letti Beds

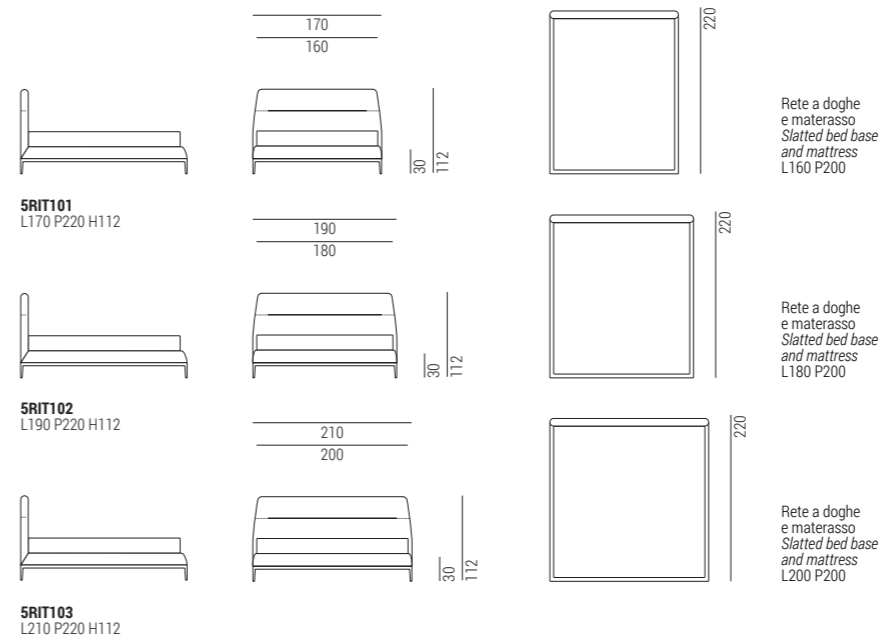

Cuscini Cushions

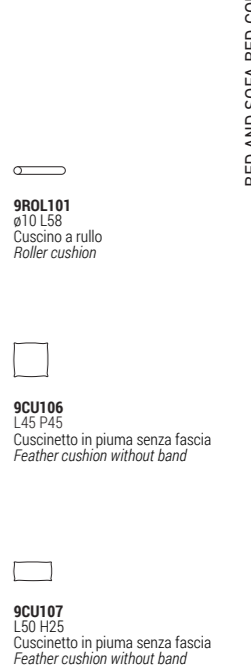

Base in metallo Metal base

Base in metallo
Metal Base



Code	RAL 9017 black painted metal OPM6	Classic bronze painted metal OPM9	Golden beach painted metal OPM10	Gold pearl painted metal OPM11	Brushed antique gold metal OPM15	Anodyc Bronze metal OPM18	Dark bronze painted metal OPM21
------	--	--	---	---	---	--	--

Schede tecniche

TECHNICAL INFORMATION

Divani letto

SOFA BEDS

marelli

Le speciali caratteristiche di questo meccanismo letto brevettato consentono l'apertura e la chiusura del divano con un unico e semplice movimento, senza la necessità di rimuovere i cuscini della seduta e dello schienale che rimangono ancorati alla struttura del meccanismo. Struttura portante del meccanismo in tubo in metallo ad alta resistenza verniciato a polvere epossidica. I braccioli, lo schienale e la fascia anteriore sono fissati con innesti a baionetta per poterli facilmente smontare in fase di trasporto. Rete ortopedica a maglia elettrosaldata, completamente rivestita in trapuntino. Tutte le parti in metallo del meccanismo sono rivestite in tessuto, e le maniglie di apertura sono ricoperte in pelle. Materasso a molle Bonnel, alto 14 cm e lungo 200 cm (tolleranza circa 1%). La struttura dei braccioli, dello schienale e della fascia anteriore sono in legno massello e legno multistrato. L'imbottitura è in poliuretano espanso rivestito in vellutino bianco. Cuscini di seduta in poliuretano espanso con densità di 40kg/m³, cuscini di schienale in poliuretano espanso con densità di 30 kg/m³, rivestito in fibre termolegate e in tessuto di puro cotone. Spazio per riporre i cuscini dietro lo schienale. Completamente sfoderabile in tessuto, non sfoderabile in pelle e in finta pelle.

The special features of this patented bed mechanism allow the opening and the closing of the sofa with only one movement, without removing the seat and back cushions, which remain attached to the frame of the mechanism. Mechanism frame in highly resistant metal tube painted with epoxy powder. Armrests, backrest and front band fixed with bayonet joints for an easy disassembly during transport. Welded orthopedic mesh bed base, completely covered in dacron. All metal parts of the mechanism are covered in fabric, and the opening handles are covered in leather. Bonnel spring mattress cm. 200 x 14h. (tolerance approx. 1%). Armrests, backrest and front band frame made of solid wood and multiply wood, upholstered with polyurethane foam and covered with dacron. Seat cushions made of polyurethane foam with density of 40 kg/m³, back cushions made of polyurethane foam with density of 30 kg/m³ covered with dacron and pure cotton fabric. Space to contain pillows behind the backrest. Completely removable fabric covers, fixed leather and artificial leather covers.

Der patentierte Bettmechanismus aus pulverbeschichtetem Stahlrohr ermöglicht durch einfache Rotation des Ruckenteils das schnelle Verwandeln vom Sofa zum komfortablen Bett mit einer 200 cm langen und 14 cm hohen Bonell-Federkernmatratze. (Toleranz zirka 1%). Sitz- und Ruckenkissen muessen nicht entfernt werden. Alle Metallteile des Mechanismus sind mit Stoff und die Öffnunggriffe mit Leder bezogen. Die Unterfederung besteht aus einem orthopaedischen elektogeschweissten Stahlgitter, mit Dacron komplett bezogen. Armlehnen, Ruckenteil und Blenden sind aus abgepolstertem Massiv- und Schichtholz und werden mit Keilbeschlaegen an dem Gestell befestigt. Die Sitzkissen bestehen aus Polyurethenschaumstoff 40 Kg/m³, die Ruckekissen aus Polyurethanschaumstoff 30 Kg/m³, mit Dacron ummantelt. Stauraum fuer Kissen in der Ruckelehne. Stoffbezeuge alle abziehbar, Leder und Kunstleder festbezogen.

Les caractéristiques spéciales de ce mécanisme-lit breveté permettent l'ouverture et la fermeture du canapé avec un seul mouvement facile, sans enlever les coussins d'assise qui restent fixés à la structure du mécanisme. Structure du mécanisme en tube métallique à haute résistance, laqué aux poudres époxydiques. Accoudoirs, dossier et bande antérieure fixés à l'aide de baïonnettes pour un facile démontage au moment du transport. Sommier en métal soudé, entièrement recouvert de dacron. Toutes les parties métalliques du mécanisme sont recouvertes de tissu et les poignées d'ouverture sont recouvertes de cuir. Matelas à ressorts Bonnel de cm. 200 x 14h. (marge de tolérance environ 1%). Structure des accoudoirs, du dossier et de la bande antérieure constituée de bois massif et de bois multiplis. Rembourrage en mousse polyuréthane revêtu de dacron. Coussins d'assise en mousse polyuréthane avec densité de 30 kg/m³, coussins de dossier en mousse polyuréthane avec densité de 30 kg/m³, recouvert de dacron et d'un tissu de pur coton. Espace de rangement pour oreillers disponible derrière le dossier. Revêtements en tissu complètement déhoussables, revêtements en cuir et cuir look non déhoussables.



Adam

DESIGN
SP PROJECT
2022

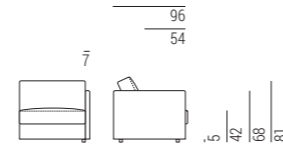

174

BED AND SOFA BED COLLECTION 2023 _ MARELLI

Divani
Sofas

Accessori
Accessories

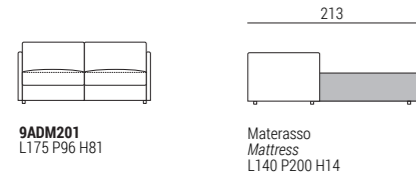

9ADM201
L175 P96 H81

Materasso
Mattress
L140 P200 H14

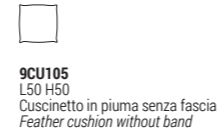

9CU105
L50 H50
Cuscinetto in piuma senza fascia
Feather cushion without band

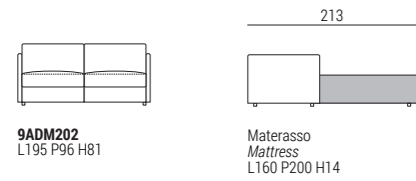

9ADM202
L195 P96 H81

Materasso
Mattress
L160 P200 H14

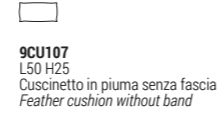

9CU107
L50 H25
Cuscinetto in piuma senza fascia
Feather cushion without band

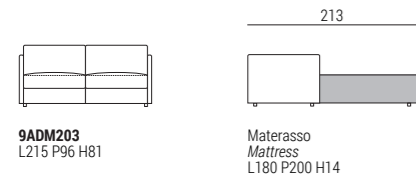

9ADM203
L215 P96 H81

Materasso
Mattress
L180 P200 H14

Demon

DESIGN
SP PROJECT
2022

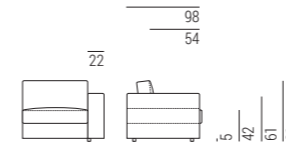

175

BED AND SOFA BED COLLECTION 2023 _ MARELLI

Divani
Sofas

Accessori
Accessories

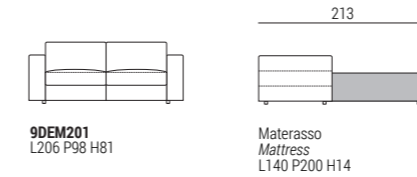

9DEM201
L206 P98 H81

Materasso
Mattress
L140 P200 H14

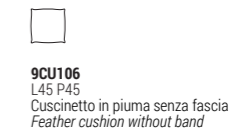

9CU106
L45 P45
Cuscinetto in piuma senza fascia
Feather cushion without band

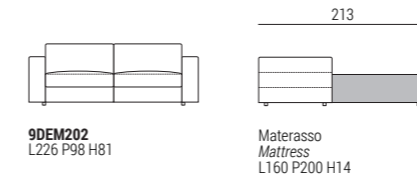

9DEM202
L226 P98 H81

Materasso
Mattress
L160 P200 H14

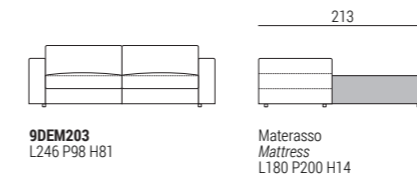

9DEM203
L246 P98 H81

Materasso
Mattress
L180 P200 H14

Kendall

DESIGN
SP PROJECT
2022

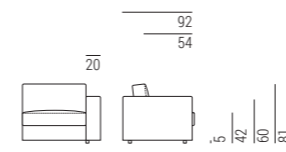
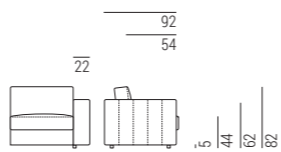

Logan

DESIGN
SP PROJECT
2022

Divani
Sofas

Dormeuse
Longchair

Accessori
Accessories

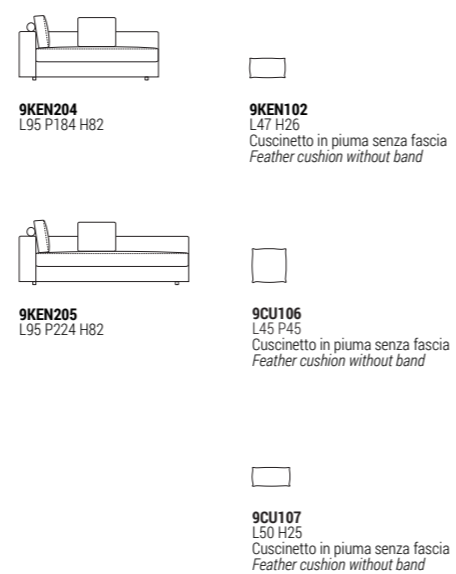
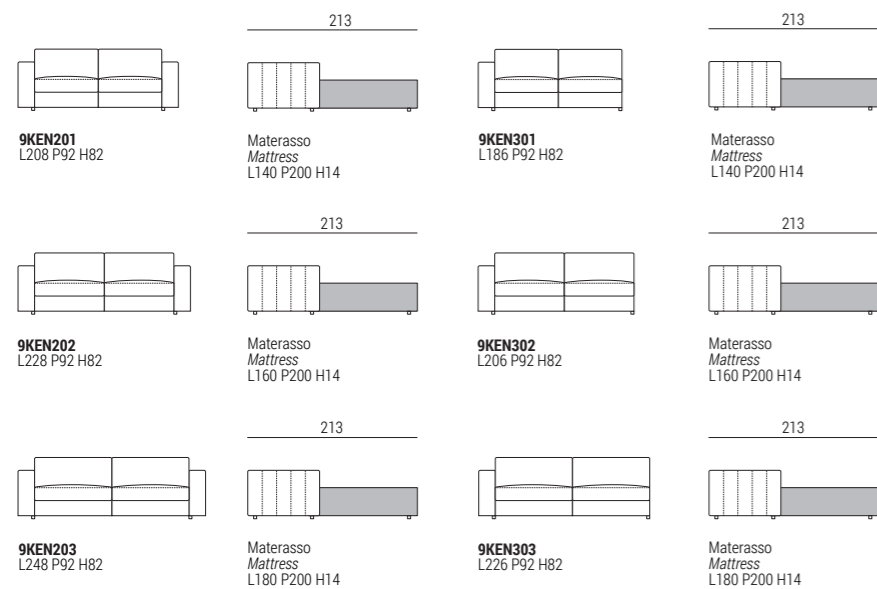

Divani
Sofas

Accessori
Accessories

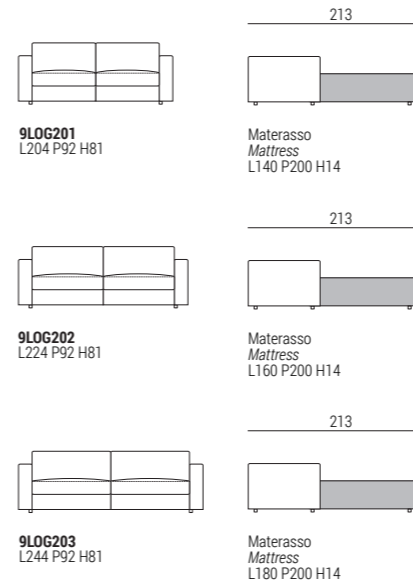

Lucas

DESIGN
SP PROJECT
2022

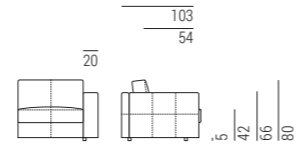

Divani
Sofas

Accessori
Accessories

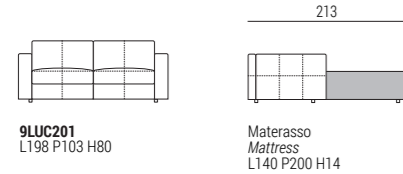

9LUC201
L198 P103 H80

Materasso
Mattress
L140 P200 H14

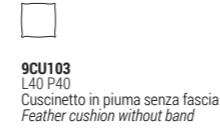

9CU103
L40 P40

Cuscinetto in piuma senza fascia
Feather cushion without band

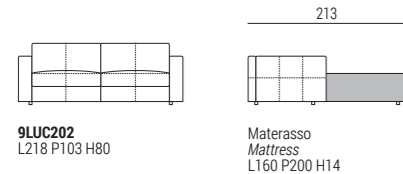

9LUC202
L218 P103 H80

Materasso
Mattress
L160 P200 H14

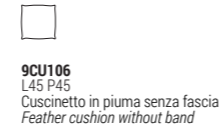

9CU106
L45 P45

Cuscinetto in piuma senza fascia
Feather cushion without band

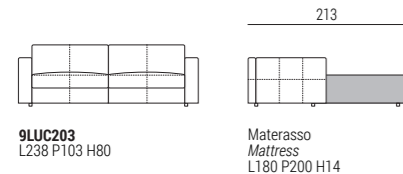

9LUC203
L238 P103 H80

Materasso
Mattress
L180 P200 H14

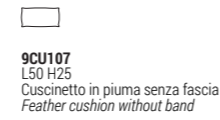

9CU107
L50 H25

Cuscinetto in piuma senza fascia
Feather cushion without band

Schede tecniche

TECHNICAL INFORMATION

Complementi

COMPLEMENTS

Paris

DESIGN
ELEONORA POZZI
2016

182

BED AND SOFA BED COLLECTION 2023 _ MARELLI

Poggiapiedi
Footstools



9PAR105
L41 P31 H50
Stool



9PAR106
L53 P40 H50
Stool



9PAR107
L130 P40 H50
Bench



9PAR105X
L41 P31 H50
Stool with covered base



9PAR106X
L53 P40 H50
Stool with covered base



9PAR107X
L130 P40 H50
Bench with covered base

Finiture *Finishes*

Base in legno
Wooden base



Code

Cherry stained oak **OPR1** Wengé stained oak **OPR2** Walnut stained oak **OPR3** Natural oak **OPR4** Black stained oak **OPR5** Cherry Milano stained oak **OPR6**



Code

Tobacco stained oak **OPR8** Grey taupe **OPR9** Whitened oak **OPR10** Charcoal stained oak **OPR11** Mahogany stained oak **OPR12** Moka matt stained oak **OPR15**

Base in rovere rivestita in tessuto/pelle
Oak base covered in fabric/leather

183

BED AND SOFA BED COLLECTION 2023 _ MARELLI

graphic

Matteo Paoloni

concept and stylist creator

Morena Colombo

photo

IKB Studio

all rights reserved © 2023

marelli**Giulio Marelli Italia SpA**

Via Indipendenza 159 20821 Meda (MB) Italia

T ++39 0362 342116

info@giuliomarelli.com www.giuliomarelli.com





marelli

Giulio Marelli Italia SpA

Via Indipendenza 159 20821 Meda (MB) Italia T ++39 0362 342116
info@giuliomarelli.com www.giuliomarelli.com