



Marelli Collection 2025

marelli

Marelli
Collection
2025

marelli



RUBELLI®

DOMINIQUE
Kieffer
BY RUBELLI

SAHCO

CASAMANCE

MISIA
PARIS

DEDAR
MILANO



ZR

ZIMMER+ROHDE

Indice prodotti

PRODUCT LIST

Divani

SOFAS

Andy
PAGE 94 | 342



Atacama
PAGE 300 | 310



Jeff
PAGE 268 | 326



Matheus
PAGE 96 | 344



Milo
PAGE 10 | 52 | 72 | 114 | 138 | 156 | 178 | 194 | 212



Moon
PAGE 246 | 316



Noah
PAGE 34 | 228 | 322



Yann
PAGE 42 | 252 | 262 | 292



Sedie e poltrone

CHAIRS AND ARMCHAIRS

Afra
PAGE 170 | 220



Bea
PAGE 338



Brera
PAGE 206



Chia
PAGE 66 | 148 | 188



Clara
PAGE 72



Jeff
PAGE 270



Joy
PAGE 344



Linda
PAGE 24 | 86 | 128 | 240 | 358



Milo
PAGE 114 | 138 | 156 | 220



Moon
PAGE 246 | 316



Noah
PAGE 34 | 228 | 322



Sign
PAGE 110 | 252 | 262



Pouf

OTTOMANS

Moon

PAGE 158 | 178 | 246 | 270 | 292 | 316 | 378



Loveseat

LOVESEAT

Milo

PAGE 202



Specchio

MIRROR

Theo

PAGE 114 | 138



Madie

SIDEBARDS

George

PAGE 174

Theo

PAGE 24 | 52 | 72 | 138 | 240 | 292 | 372



Kyoto

PAGE 344 | 358



Letti

BEDS

Noah

PAGE 378 | 384



Milo

PAGE 368



Consolle

CONSOLE

Onno

PAGE 114



Libreria

BOOKSHELF

Onno

PAGE 34 | 304 | 332



Comodini

BEDSIDE TABLES

Arnold

PAGE 368 | 384

Onno

PAGE 378



Tavoli da pranzo

DINING TABLES

Hebo
PAGE 358



Onno
PAGE 24 | 128 | 220



Simmy
PAGE 72



Wave
PAGE 66 | 148 | 170 | 188 | 240 | 338



Wave Round Dining Table
PAGE 338



Tavolini

COFFEE TABLES

Arthur
PAGE 10 | 34 | 42 | 110 | 208 | 252 | 312 | 316



Atene
PAGE 178 | 270 | 328



Break
PAGE 270



Kofi
PAGE 52 | 202 | 262



Kyle
PAGE 42



Leaf
PAGE 96



Lua
PAGE 56 | 322



Onno
PAGE 114 | 156 | 194 | 214 | 252 | 368



Simmy
PAGE 72



Thor
PAGE 96 | 138



Wave
PAGE 212 | 228 | 246 | 292 | 302 | 344



MILO composition cm 435x195
Fabric: cat. D/E art. Clusone 04

Extra cushion:
1 x 9CU105 cm 50x50
Fabric: cat. D/E art. Clusone 04

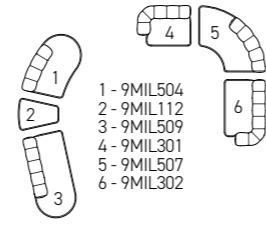

MILO composition cm 317x350
Fabric: cat D/E art. Clusone 04

Extra cushions:
2 x 9CU105 cm 50x50
1 x 9CU106 cm 45x45
Fabric: cat D/E art. Clusone 04

ARTHUR tables
7ART201 ø cm 50x50h
7ART202 ø cm 60x40h
7ART203 ø cm 120x30h
Base: OPM18 anodyc bronze painted metal
Top: OPP7 Calacatta marble



MILO composition cm 317x350
 Fabric: cat D/E art. Clusone 04

Extra cushions:
 2 x 9CU105 cm 50x50
 1 x 9CU106 cm 45x45
 Fabric: cat D/E art. Clusone 04

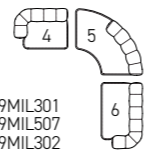

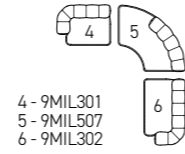

MILO composition cm 317x350
Fabric: cat D/E art. Clusone 04

Extra cushions:
2 x 9CU105 cm 50x50
1 x 9CU106 cm 45x45
Fabric: cat D/E art. Clusone 04

ARTHUR tables
7ART201 ø cm 50x50h
7ART202 ø cm 60x40h
7ART203 ø cm 120x30h
Base: OPM18 anodized bronze painted metal
Top: OPP7 Calacatta marble





ARTHUR tables
7ART201 ø cm 50x50h
7ART203 ø cm 120x30h
Base: OPM18 anodyc bronze painted metal
Top: OPP7 Calacatta marble





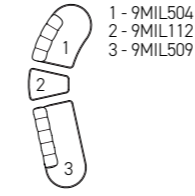

1 - 9MIL504
2 - 9MIL112
3 - 9MIL509

MIL0 composition cm 435x195
Fabric: cat. D/E art. Clusone 04

Extra cushion:
1 x 9CU105 cm 50x50
Fabric: cat. D/E art. Clusone 04

ARTHUR tables
7ART201 ø cm 50x50h
7ART203 ø cm 120x30h
Base: OPM18 anodyc bronze painted metal
Top: OPP7 Calacatta marble





Details of **MILO** sofa
in fabric cat. D/E art. Clusone 04





THEO sideboard
7THE106 cm 240x55x70h
 Structure: OPR15 moka matt stained oak
 Top: OPP20 Arabescato orobico grey marble
 Handles: OPM15 antique gold brushed metal

ONNO bespoke table cm 520x150x74h
 Top: OPP2 Marquinia black marble
 Legs: OPR5 black stained oak

LINDA chairs
9LIN101 cm 62x58x78h
 Fabric: cat. F/G art. Orsetto 01/1
 Legs: OPM18 anodyc bronze painted metal

ONNO bespoke table cm 520x150x74h
 Top: OPP2 Marquinia black marble
 Legs: OPR5 black stained oak

LINDA chairs
9LIN101 cm 62x58x78h
 Fabric: cat. F/G art. Orsetto 01/1
 Legs: OPM18 anodized bronze painted metal

THEO sideboard
7THE106 cm 240x55x70h
 Structure: OPR15 moka matt stained oak
 Top: OPP20 Arabescato orobico grey marble
 Handles: OPM15 antique gold brushed metal





ONNO bespoke table cm 520x150x74h
Top: OPP2 Marquinia black marble
Legs: OPR5 black stained oak

LINDA chairs
9LIN101 cm 62x58x78h
Fabric: cat. F/G art. Orsetto 01/1
Legs: OPM18 anodized bronze painted metal



Details of OPP2 Marquinia black marble

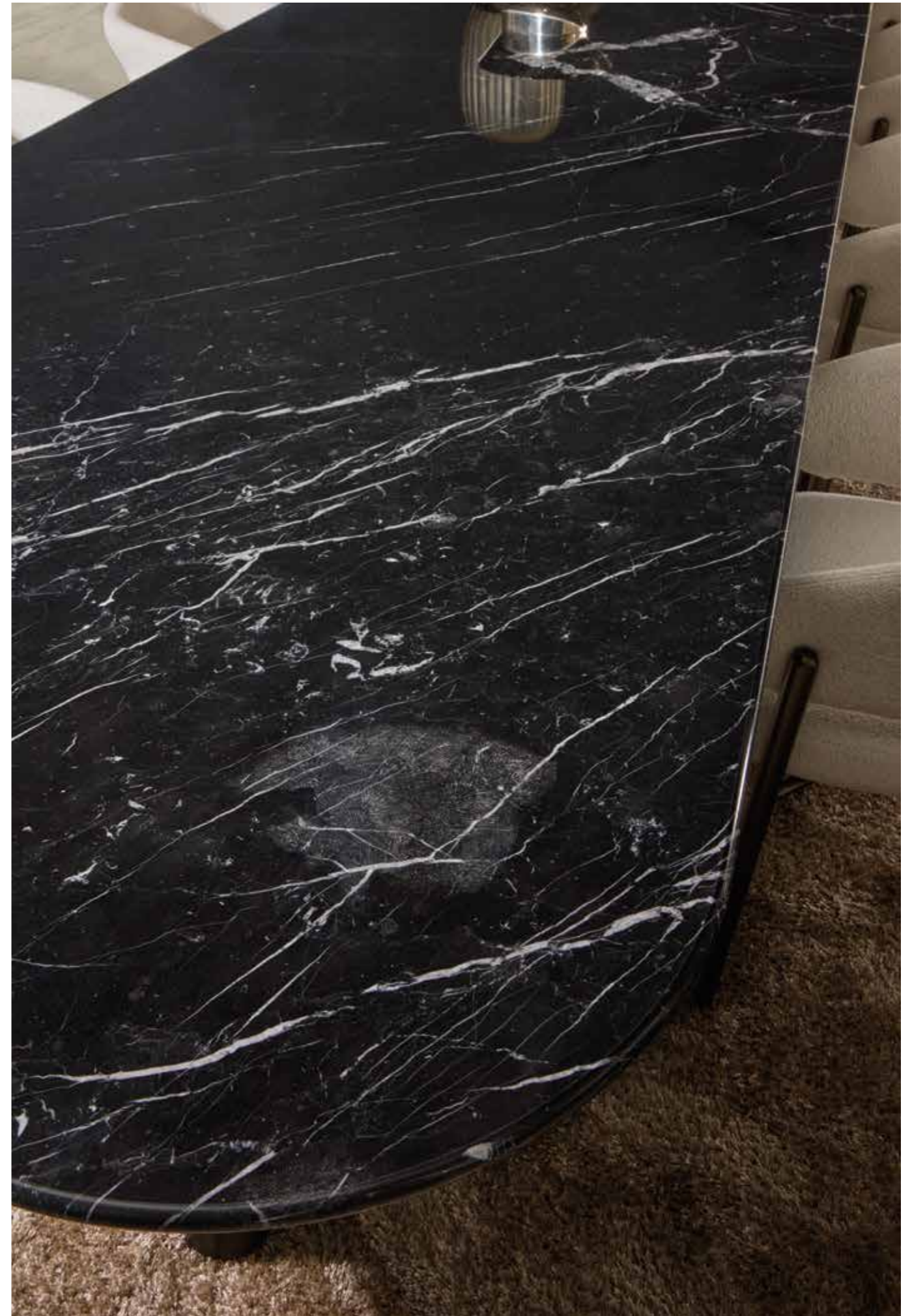



LINDA chairs
9LIN101 cm 62x58x78h
Fabric: cat. F/G art. Orsetto 01/1
Legs: OPM18 anodyc bronze painted metal





ONNO bookshelf
70N301 cm 200x38x198h
 Shelves: OPR15 moka matt stained oak
 Elements in matt beige painted MDF

NOAH sofas
9NH202 cm 250x100x76.5h
NOAH armchair
9NH101 cm 90x90x76.5h
 Fabric: cat. F/G art. Misia Aime M188 420 cuivre

ARTHUR tables
7ART204 ø cm 100x30h
7ART201 ø cm 50x50h
7ART202 ø cm 60x40h
 Base: OPM16 shiny brass chrome metal
 Top: OPP4 Beige Brera Stone

NOAH sofas
9NH202 cm 250x100x76.5h
NOAH armchair
9NH101 cm 90x90x76.5h
Fabric: cat. F/G art. Misia Aime M188 420 cuivre

ARTHUR tables
7ART204 ø cm 100x30h
7ART201 ø cm 50x50h
7ART202 ø cm 60x40h
Base: OPM16 shiny brass chrome metal
Top: OPP4 Beige Brera Stone





NOAH armchair
9NH101 cm 90x90x76.5h
Fabric: cat. F/G art. Misia Aime M188 420 cuivre

Details of **NOAH sofa** and **ARTHUR side table**



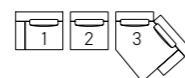

1 - 9YA201
2 - 9YA301
3 - 9YA604

YANN composition cm 427x185
Fabric: cat. F/G art. Orsetto 01/1

Extra cushions:
4 x 9CU106 cm 45x45
Fabric: cat. F/G art. Orsetto 01/1
2 x 9CU106 cm 45x45
Fabric: Zimmer + Rohde art. Rythm 10961/895

KYLE server table
7KYL101 ø cm 36x50h
Base: OPM14 shiny black chrome metal
Top: OPP20 Arabescato orobico grey marble

ARTHUR tables
7ART207 cm 90x90x30h
7ART206 cm 60x60x40h
Base: OPM14 shiny black chrome metal
Top: OPP2 Marquinia black marble





KYLE server table
7KYL101 ø cm 36x50h
Base: OPM14 shiny black chrome metal
Top: OPP20 Arabescato orobico grey marble

YANN sofa
in fabric cat. F/G art. Orsetto col. 01/1



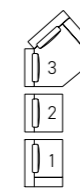

1 - 9YA201
2 - 9YA301
3 - 9YA604

YANN composition cm 427x185
Fabric: cat. F/G art. Orsetto 01/1

Cushions:
4 x 9CU106 cm 45x45
Fabric: cat. F/G art. Orsetto 01/1
2 x 9CU106 cm 45x45
Fabric: Zimmer + Rohde art. Rythm 10961/895

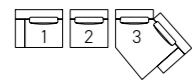

- 1 - 9YA201
- 2 - 9YA301
- 3 - 9YA604

ARTHUR tables
7ART207 cm 90x90x30h
7ART206 cm 60x60x40h
7ART205 cm 50x50x50h

Base: OPM14 shiny black chrome metal
 Top: OPP2 Marquinia black marble

YANN composition
 in fabric cat. F/G art. Orsetto 01/1

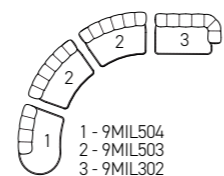

1 - 9MIL504
2 - 9MIL503
3 - 9MIL302

MILO composition cm 475x400
Fabric: cat. B/C art. San Diego 171

Extra cushions:
3 x 9CU105 cm 50x50
Fabric: cat. F/G art. Orsetto 01/2
2 x 9CU106 cm 45x45
Fabric: cat. F/G art. Orsetto 07/24

KOFI tables
7KO101 cm 60x60x48h
7KO104 cm 60x60x38h
7KO103 cm 120x120x28h
Base: OPM18 anodized bronze painted metal
Top: OPP20 Arabescato orobico grey marble

THEO sideboard
7THE104 cm 220x55x70h
Structure: OPR2 wengé stained oak
Top: OPP20 Arabescato orobico grey marble
Handles: OPM15 antique gold brushed metal

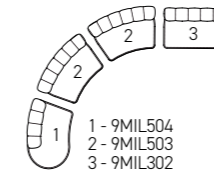

1 - 9MIL504
2 - 9MIL503
3 - 9MIL302

MILO composition cm 475x400
Fabric: cat. B/C art. San Diego 171

Extra cushions:
3 x 9CU105 cm 50x50
Fabric: cat. F/G art. Orsetto 01/2
2 x 9CU106 cm 45x45
Fabric: cat. F/G art. Orsetto 07/24

KOFI tables
7K0101 cm 60x60x48h
7K0103 cm 120x120x28h
Base: OPM18 anodyc bronze painted metal
Top: OPP20 Arabescato orobico grey marble





MILO sofa composition cm 420x265
 Fabric: cat. F/G Casamance Alpine 0360 beige

Extra cushions:
2 x 9CU103 cm 40x40
 in fabric cat. F/G Casamance Alpine 0360 beige
2 x 9CU105 cm 50x50
 in fabric cat. F/G Casamance Alpine 0360 beige
1 x 9CU103 cm 40x40
 in fabric cat. H art. Zimmer + Rohde Rhythm 587
1 x 9CU105 cm 50x50
 in fabric cat. H art. Zimmer + Rohde Rhythm 587
1 x 9CU103 cm 40x40
 in fabric cat. F/G art. Misia Aime col. M346308 ardoise

LUA coffee tables
7LU205 ø cm 120x25h
 Top: OPP7 Calacatta marble
 Base: OPM20 Délabré brass brushed painted MDF
7LU203 ø cm 60x48h
 Top: OPP7 Calacatta marble
 Bases: Shiny beige painted MDF
7LU201 ø cm 60x25h
 Top: OPP7 Calacatta marble
 Base: Shiny beige painted MDF

LUA coffee tables
7LU205 ø cm 120x25h
Top: OPP7 Calacatta marble
Base: OPM20 Délabré brass brushed painted MDF
7LU202 ø cm 60x35h
Top: OPP7 Calacatta marble
Base: OPM20 Délabré brass brushed metal pipe
+ painted MDF
7LU203 ø cm 60x48h
Top: OPP7 Calacatta marble
Bases: Shiny beige painted MDF
7LU201 ø cm 60x25h
Top: OPP7 Calacatta marble
Base: Shiny beige painted MDF



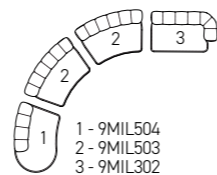

MILO composition cm 475x400
Fabric: cat. B/C art. San Diego 171

Extra cushions:
3 x 9CU105 cm 50x50
Fabric: cat. F/G art. Orsetto 01/2
2 x 9CU106 cm 45x45
Fabric: cat. F/G art. Orsetto 07/24

KOFI tables
7KO101 cm 60x60x48h
7KO104 cm 60x60x38h
7KO103 cm 120x120x28h
Base: OPM18 anodyc bronze painted metal
Top: OPP20 Arabescato orobico grey marble





KOFI tables
7KO101 cm 60x60x48h
7KO104 cm 60x60x38h
7KO103 cm 120x120x28h
 Base: OPM18 anodized bronze painted metal
 Top: OPP20 Arabescato orobico grey marble





THEO sideboard
7THE104 cm 220x55x70h
Structure: OPR2 wengé stained oak
Top: OPP20 Arabescato orobico grey marble
Handles: OPM15 antique gold brushed metal

WAVE dining table bespoke cm 380x110x74h
Base: OPM15 antique gold brushed metal
Top: OPP13 Velvet brown marble

CHIA small armchairs
9CHI104 cm 58x53x77h
Outside: Leather cat. Extra art. Levante 5608
Inside: Fabric cat. F/G art. Casamance Alma 7388 1245
Base: OPM15 antique gold brushed metal





WAVE dining table bespoke cm 380x110x74h
 Base: OPM15 antique gold brushed metal
 Top: OPP13 Velvet brown marble

CHIA small armchairs
9CHI104 cm 58x53x77h
 Outside: Leather cat. Extra art. Levante 5608
 Inside: Fabric cat. F/G art. Casamance Alma 7388 1245
 Base: OPM15 antique gold brushed metal



CHIA small armchairs
9CHI104 cm 58x53x77h
Outside: Leather cat. Extra art. Levante 5608
Inside: Fabric cat. F/G art. Casamance Alma 7388 1245
Base: OPM15 antique gold brushed metal

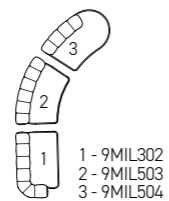

1 - 9MIL302
2 - 9MIL503
3 - 9MIL504

MIL0 composition cm 470x232

Leather: cat. Extra art. Sofio C50 62 col. Giglio

Extra cushions:

2 x 9CU106 cm 45x45

Leather: cat. Extra art. Sofio C50 62 col. Giglio

2 x 9CU106 cm 45x45

Fabric: cat. F/G art. Misia Aime M356308 Levallière

SIMMY coffee tables

7SIM211 cm 140x140x27h

7SIM204 ø cm 90x37h

7SIM201 ø cm 60x37h

Upper top: OPP22 Travertino marble

Lower top: Shiny beige painted MDF

Base: OPP22 Travertino marble

SIMMY dining table

7SIM306 cm 260x110x74h

Upper top: OPP22 Travertino marble

Lower top: Shiny beige painted MDF

Base: OPP22 Travertino marble

CLARA chairs

9CLA102 cm 51x55x79h

Fabric: cat. F/G art. Misia Aime M356308 Levallière

Base: OPM15 antique gold brushed metal

THEO sideboard

7THE103 cm 240x55x70h

Top: OPP22 Travertino marble

Structure: OPR15 moka matt stained oak

Handles: OPM15 antique gold brushed metal



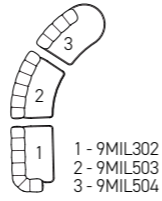

1 - 9MIL302
2 - 9MIL503
3 - 9MIL504

MILO composition cm 470x232

Leather: cat. Extra art. Sofio C50 62 col. Giglio

Extra cushions:

2 x 9CU106 cm 45x45

Leather: cat. Extra art. Sofio C50 62 col. Giglio

2 x 9CU106 cm 45x45

Fabric: cat. F/G art. Misia Aime M356308 Levallière

SIMMY coffee tables

7SIM211 cm 140x140x27h

7SIM204 ø cm 90x37h

7SIM201 ø cm 60x37h

Upper top: OPP22 Travertino marble

Lower top: Shiny beige painted MDF

Base: OPP22 Travertino marble





Details of **MILO sofa**
in leather cat. Extra art. C50 col. Giglio



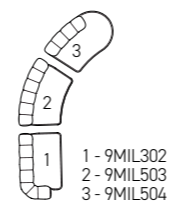

1 - 9MIL302
2 - 9MIL503
3 - 9MIL504

MILO composition cm 470x232

Leather: cat. Extra art. Soffio C50 62 col. Giglio

Extra cushions:

2 x 9CU106 cm 45x45

Leather: cat. Extra art. Soffio C50 62 col. Giglio

2 x 9CU106 cm 45x45

Fabric: cat. F/G art. Misia Aime M356308 Levallière





Detail of **SIMMY** dining table
in OPP22 Travertino marble

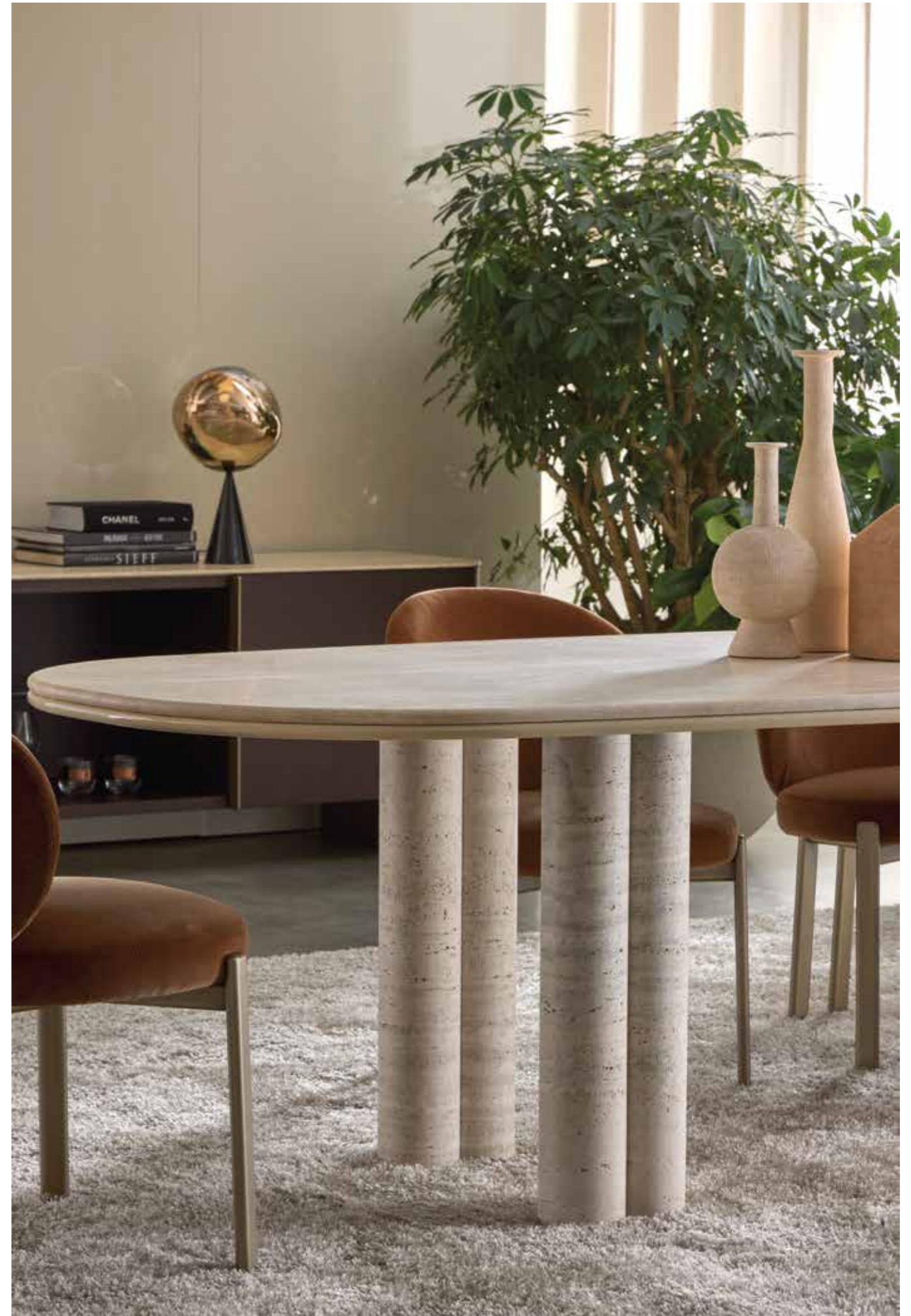



SIMMY dining table
7SIM306 cm 260x110x74h
 Upper top: OPP22 Travertino marble
 Lower top: Shiny beige painted MDF
 Base: OPP22 Travertino marble

CLARA chairs
9CLA102 cm 51x55x79h
 Fabric: cat. F/G art. Misia Aime M356308 Levallière
 Base: OPM15 antique gold brushed metal





SIMMY dining table
7SIM306 cm 260x110x74h
Upper top: OPP22 Travertino marble
Lower top: Shiny beige painted MDF
Base: OPP22 Travertino marble

LINDA chairs
9LIN102 cm 62x58x78h
Fabric: cat. F/G Casamance Alpine 0360 beige
Base: OPM20 Délabré brass brushed metal



SIMMY dining table**7SIM306 cm 260x110x74h**Upper top: OPP22 Travertino marble
Lower top: Shiny beige painted MDF
Base: OPP22 Travertino marble**LINDA chairs****9LIN102 cm 62x58x78h**Fabric: cat. F/G Casamance Alpine 0360 beige
Base: OPM20 Délabré brass brushed metal



SIMMY coffee tables
7SIM204 ø cm 90x37h
7SIM201 ø cm 60x37h
7SIM211 cm 140x140x27h
 Upper top: OPP22 Travertino marble
 Lower top: Shiny beige painted MDF
 Base: OPP22 Travertino marble





Detail of **THEO sideboard**
7THE103 cm 240x55x70h
Top: OPP22 Travertino marble
Structure: OPR15 moka matt stained oak
Handles: OPM15 antique gold brushed metal



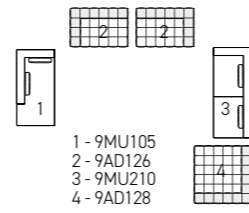

1 - 9MU105
2 - 9AD126
3 - 9MU210
4 - 9AD128

MATHEUS longchair
9MU105 cm 200x100x88h
Fabric: cat. F/G art. Kieffer
by Rubelli Velours Soleil 17189-002 Naturel
Base: OPM21 dark bronze painted metal

Extra cushion:
1 x 9CU106 cm 45x45
Leather: cat. Extra art. Sofio C50 62 col. Giglio

THOR tables
7TH102 cm 100x100x19h
7TH104 cm 50x50x50h
OPP11 Grey Stone matt marble

ANDY composition
cm 300x100x65h
Leather: cat. Extra art. Manhattan 2176
Base: OPM21 dark bronze painted metal

LEAF server table
7LE101 cm 64x25x51h
OPM15 antique gold brushed metal

ANDY+MATHEUS composition
cm 390x150
Fabric: cat. F/G art. Kieffer by Rubelli Velours Soleil 17189-002 Naturel
Base: OPM21 dark bronze painted metal





LEAF server table
7LE101 cm 64x25x51h
OPM15 antique gold brushed metal

Detail of **ANDY sofa**
in fabric cat. F/G art. Kieffer by Rubelli Velours Soleil 17189-002 Naturel



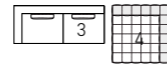

3 - 9MU210
4 - 9AD128

ANDY+MATHEUS composition cm 390x150
Fabric: cat. F/G art. Kieffer by Rubelli Velours Soleil 17189-002 Naturel
Base: OPM21 dark bronze painted metal

Extra cushion:
1 x 9CU106 cm 45x45
Leather: cat. Extra art. Soffio C50 62 col. Giglio

THOR table
7TH102 cm 100x100x19h
OPP11 Grey Stone matt marble

LEAF server table
7LE101 cm 64x25x51h
OPM15 antique gold brushed metal



ANDY composition
cm 300x100x65h

Leather: cat. Extra art. Manhattan 2176
Base: OPM21 dark bronze painted metal



1 - 9AD126





Detail of quilted **sofa ANDY** and Grey Stone marble







SIGN armchair
95x112 cm 83x75x75h
Fabric: cat. F/G art. Misia Aime M356 308 Lavalliere
Base: OPM18 anodyc bronze painted metal

ARTHUR tables
7ART208 cm 100x100x30h
Base: OPM15 antique gold brushed metal
Top: OPP7 Calacatta marble



ARTHUR tables**7ART205 cm 50x50x50h****7ART206 cm 60x60x40h****7ART208 cm 100x100x30h**Base: OPM15 antique gold brushed metal
Top: OPP7 Calacatta marble**SIGN armchairs****9SI112 cm 83x75x75h**Fabric: cat. F/G art. Misia Aime M356 308 Lavalliere
Base: OPM18 anodyc bronze painted metal

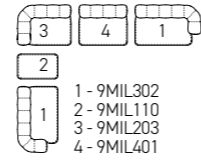

MILO composition cm 348x445
Fabric: Zimmer + Rohde Comfy Bouclé 10958-981

Extra cushions:
3 x 9CU106 cm 45x45
Fabric: Zimmer + Rohde Comfy Bouclé 10958-981
2 x 9CU108 cm 55x55
Fabric: Zimmer + Rohde Comfy Bouclé 10958-981
2 x 9CU108 cm 55x55
Fabric: cat. H art. Rubelli Spritz col. 07 castagna

MILO armchairs
9MIL101 cm 96x78x70h
Leather: Cat. Lusso art. Nabuk C3412

ONNO tables
7ON105 cm 120x120x25h
7ON101 cm 60x60x35h
7ON102 ø cm 60x35h
Bases: beige painted MDF
+ MDF painted in finish OPM20 délabré brass brushed

ONNO console
7ON302 cm 160x55x74h
Bases: OPR15 moka matt stained oak
+ MDF painted in finish OPM20 délabré brass brushed
Top: OPP7 Calacatta marble

THEO mirror
7THE101 cm 110x4,5x105h
Bronze mirror + Beige painted oak







ONNO console
70N302 cm 160x55x74h
 Bases: OPR15 moka matt stained oak
 + MDF painted in finish OPM20 délabré brass brushed
 Top: OPP7 Calacatta marble

THEO mirror
7THE101 cm 110x4,5x105h
 Bronze mirror + Beige painted oak





MILO armchairs
9MIL101 cm 96x78x70h
 Leather: Cat. Lusso art. Nabuk C3412

ONNO tables
7ON105 cm 120x120x25h
7ON101 cm 60x60x35h
7ON102 ø cm 60x35h
 Bases: Beige painted MDF
 + MDF painted in finish OPM20 délabré brass brushed
 Top: OPP7 Calacatta marble

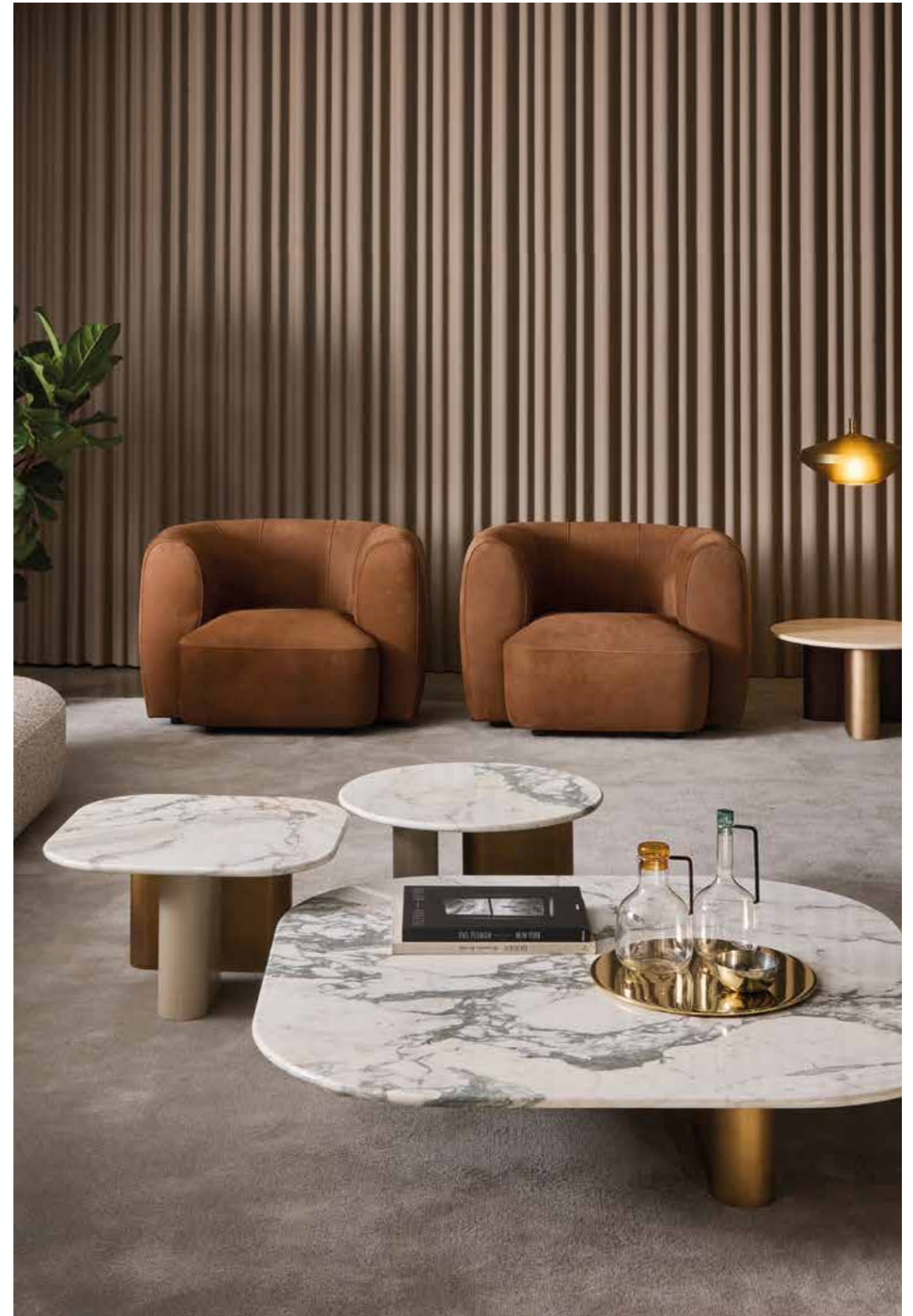

ONNO tables
70N105 cm 120x120x25h
70N101 cm 60x60x35h
70N102 ø cm 60x35h
Bases: Beige painted MDF
+ MDF painted in finish OPM20 délabré brass brushed
Top: OPP7 Calacatta marble





ONNO table
70N104 ø cm 45x45h
Bases: Beige painted MDF
+ MDF painted in finish OPM20 délabré brass brushed
Top: OPP7 Calacatta marble







ONNO dining table custom size **cm 300x150x74h**
Top: OPP7 Calacatta marble
Base: OPR15 moka matt stained oak

LINDA chairs
9LIN101 cm 62x58x78h
Fabric: cat. F/G art. Orsetto 01/2
Base: OPM18 anodyc bronze painted metal

ONNO dining table custom size **cm 300x150x74h**
Top: OPP7 Calacatta marble
Base: OPR15 moka matt stained oak

LINDA chairs
9LIN101 cm 62x58x78h
Fabric: cat. F/G art. Orsetto 01/2
Base: OPM18 anodyc bronze painted metal







LINDA chairs
9LIN102 cm 62x58x78h
Fabric: cat. F/G art. Casamance Lierna 4976 0327 sable
Base: OPM15 antique gold brushed metal

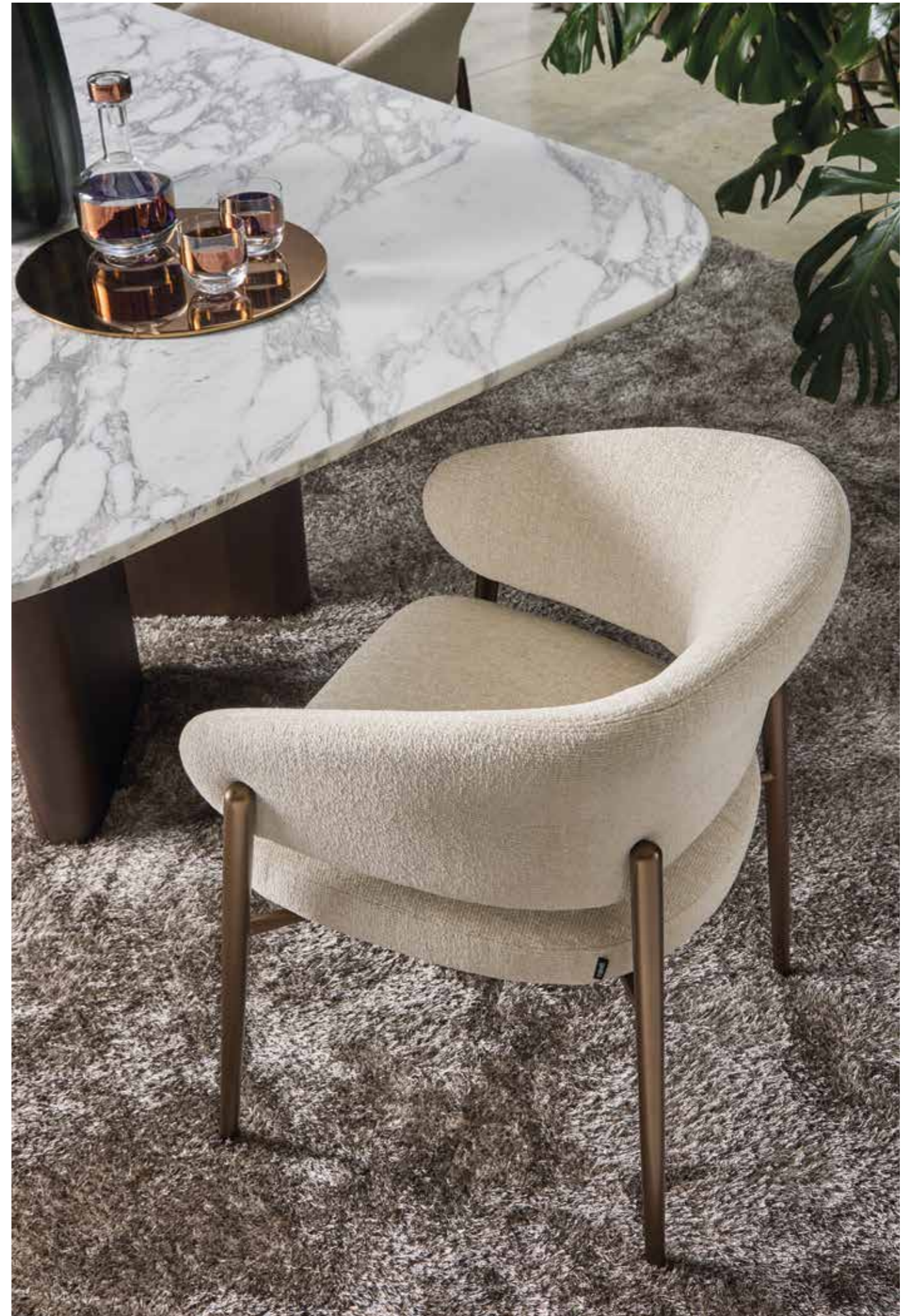

ONNO dining table
70N201 cm 260x120x74h
Top: OPP7 Calacatta gold marble
Base: Green painted oak
+ OPR15 moka matt stained oak

LINDA chairs
9LIN102 cm 62x58x78h
Fabric: cat. F/G art. Casamance Lierna 4976 0327 sable
Base: OPM15 antique gold brushed metal





MILO composition cm 350x107x70h
Fabric: cat. D/E art. Clusone 08

Extra cushions:
3 x 9CU104 cm 60x60x35h
Fabric: cat. D/E art. Clusone 08
1 x 9CU106 cm 45x45
Fabric: cat. D/E art. Valencia 1726 col. 25

MILO armchairs
9MIL101 cm 96x78x70h
Fabric: cat. D/E art. Valencia 1726 col. 25

THOR tables
7TH112 cm 100x100x27h
OPP20 Arabescato Orobito grey marble
Base: OPM15 antique gold brushed metal

THEO sideboard
7THE104 cm 220x55x70h
Structure: OPR2 wengé stained oak
Top: OPP20 Arabescato Orobito grey marble
Handles: OPM15 antique gold brushed metal

THEO mirror
7THE101 110x4,5x105h
OPM19 Délabré pewter brushed metal
Bronze mirror



1 - 9MIL302



THOR tables
7TH112 cm 100x100x27h
OPP20 Arabescato Orobito grey marble
Base: OPM15 antique gold brushed metal



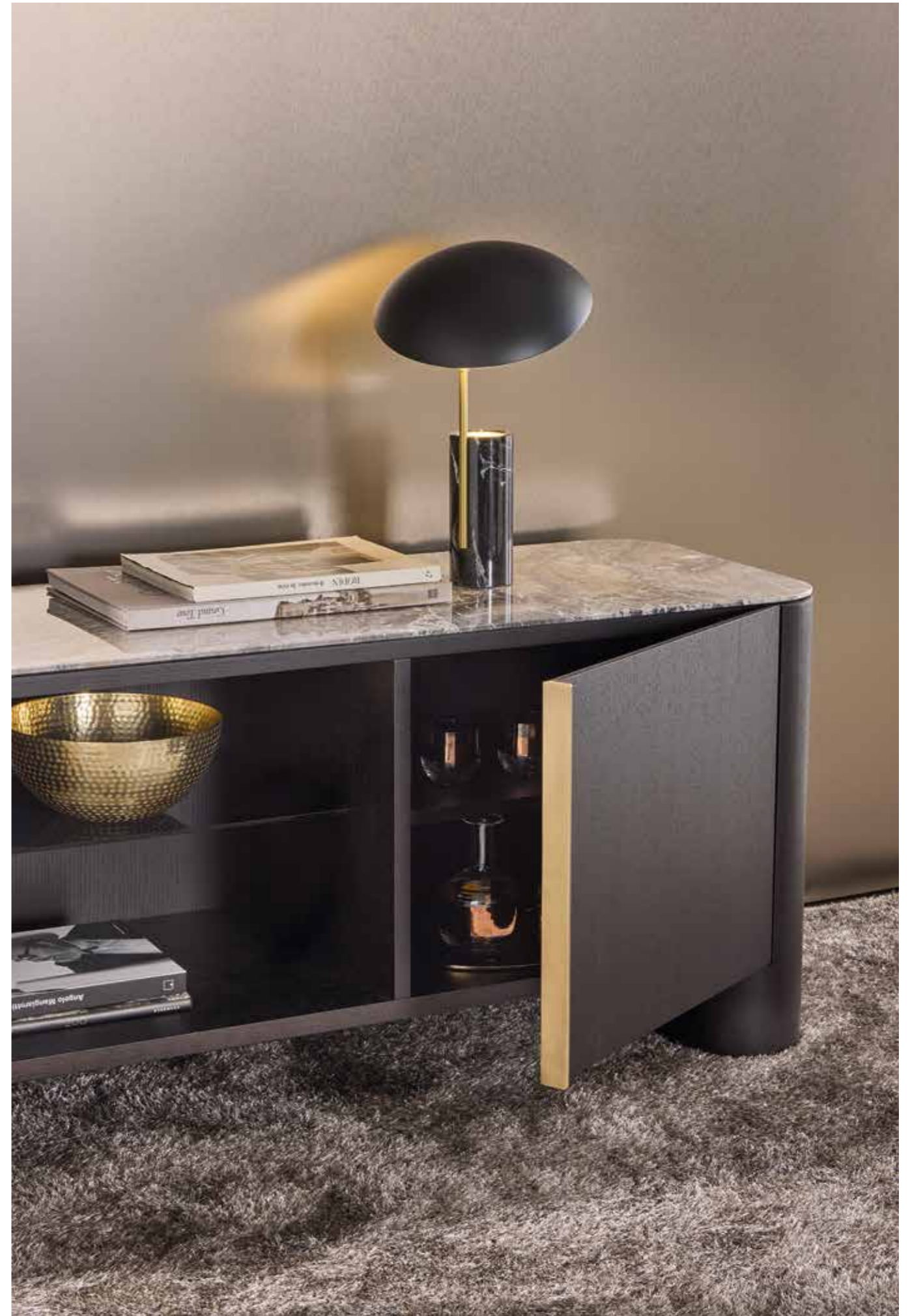

Details of MILO sofa and THEO sideboard



WAVE dining table
7WA201 cm 260x110x74h
Top: Patagonia marble
Base: OPM20 Délabré brass brushed metal

CHIA chairs
9CHI104 cm 58x53x77h
Fabric: cat. F/G art. Made F col. 19
Base: OPM21 dark bronze painted metal







WAVE dining table
7WA201 cm 260x110x74h
 Top: Patagonia marble
 Base: OPM20 Délabré brass brushed metal

CHIA chairs
9CHI104 cm 58x53x77h
 Fabric: cat. F/G art. Made F col. 19
 Base: OPM21 dark bronze painted metal





WAVE dining table
7WA201 cm 260x110x74h
Top: OPP23 Patagonia marble
Base: OPM20 Délabré brass brushed metal

MILO curved sofa
9MIL501 cm 250x107x70h
 Fabric: cat. F/G art. Misia Aime M188 429 vert olive

Extra cushions:
1 x 9CU106 cm 45x45
1 x 9CU104 cm 60x60
 Fabric: cat. F/G art. Misia Aime M188 429 vert olive

MILO curved sofa
9MIL502 cm 310x107x70h
 Fabric: cat. D/E art. Tresigallo 01 white

Cushions:
2 x 9CU106 cm 45x45
 Fabric: cat. D/E art. Tresigallo 01 white
1 x 9CU104 cm 60x60
 Fabric: cat. F/G art. Misia Aime M188 429 vert olive

MILO armchair
9MIL101 cm 96x76x70h
 Fabric: cat. D/E art. Tresigallo 01 white

ONNO coffee tables
7ON105 cm 120x120x25h
7ON101 cm 60x60x35h
7ON102 ø cm 60x35h
 Bases: MDF painted in OPM20 Délabré brass brushed finishing + OPR15 moka matt stained oak
 Top: OPP22 Travertino marble







ONNO coffee tables
70N105 cm 120x120x25h
70N101 cm 60x60x35h
70N102 ø cm 60x35h
Bases: MDF painted in OPM20 Délabré brass brushed
finishing + OPR15 moka matt stained oak
Top: OPP22 Travertino marble



MILO curved sofa back details





MILO curved sofa
9MIL501 cm 250x107x70h
 Fabric: cat. F/G art. Misia Aime M188 429 vert olive

ONNO coffee table
7ON102 ø cm 60x35h
 Bases: MDF painted in OPM20 Délabré brass brushed finishing
 + OPR15 moka matt stained oak
 Top: OPP22 Travertino marble





WAVE dining table custom size
cm 450x110x75h
Top: OPP10 Shiny Perfett brown marble
Base: OPM18 anodyc bronze painted metal

AFRA chairs
9AFR101 cm 63x59x79h
Fabric: cat. D/E art. Lucinasco 03
Base: OPR15 moka matt stained oak



WAVE dining table custom size
cm 450x110x75h
 Top: OPP10 Shiny Perfett brown marble
 Base: OPM18 anodyc bronze painted metal

AFRA chairs
9AFR101 cm 63x59x79h
 Fabric: cat. D/E art. Lucinasco 03
 Base: OPR15 moka matt stained oak

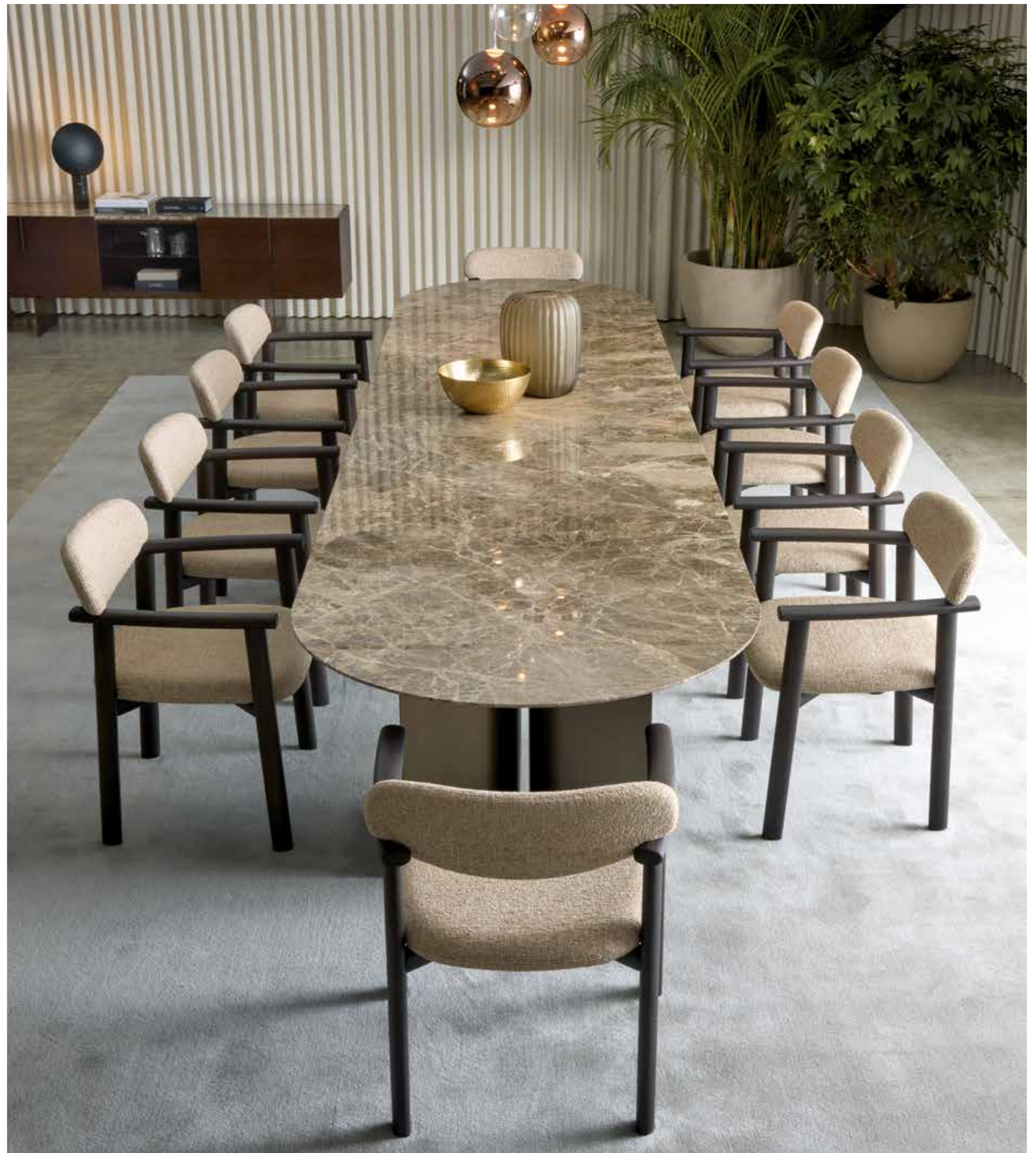

WAVE dining table custom size
cm 450x110x75h
 Top: OPP10 Shiny Perfett brown marble
 Base: OPM18 anodyc bronze painted metal

AFRA chairs
9AFR101 cm 63x59x79h
 Fabric: cat. D/E art. Lucinasco 03
 Base: OPR15 moka matt stained oak

GEORGE sideboard
7GE201 cm 220x50x71h
 Top: OPP10 shiny Perfetto brown marble
 Structure: OPR15 moka matt stained oak
 Handles: OPM18 anodyc bronze painted metal



GEORGE sideboard
7GE201 cm 220x50x71h
Top: OPP10 shiny Perfetto brown marble
Structure: OPR15 moka matt stained oak
Handles: OPM18 anodyc bronze painted metal

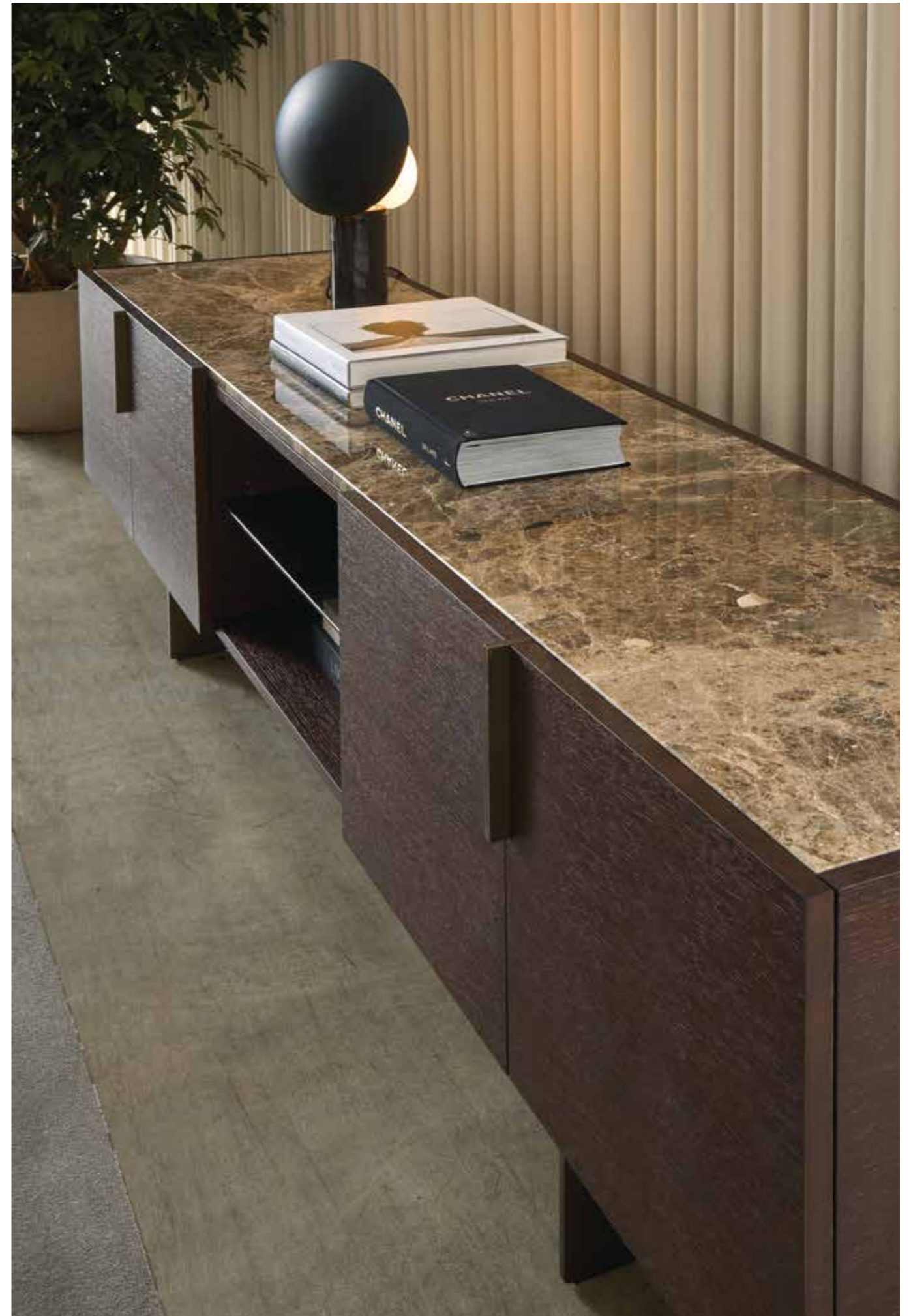



1 - 9MIL303
2 - 9MIL112
3 - 9MIL102

MILO composition cm 420x167
Fabric: cat. D/E clusone 16

Extra cushions:
2 x 9CU104 cm 60x60
2 x 9CU106 cm 45x45
Fabric: cat. D/E clusone 16
1 x 9CU104 cm 60x60
Fabric: Zimmer
+ Rohde Ardecora Giardino d'Inverno 15487 294

MOON ottoman
9MN102 ø cm 60x40h
Fabric: Zimmer
+ Rohde Ardecora Giardino d'Inverno 15487 294
Base: OPM15 antique gold brushed metal

ATENE coffee table
7AT101 ø cm 50x40h
7AT102 ø cm 50x50h
7AT104 ø cm 100x50h
Top: OPP9 Black and Gold marble
Base: OPM15 antique gold brushed metal





MILO composition cm 420x167
Fabric: cat. D/E clusione 16

Extra cushions:
3 x 9CU104 cm 60x60
2 x 9CU106 cm 45x45
Fabric: cat. D/E clusione 16

KOFI coffee tables:
7KO103 cm 120x120x28h
7KO101 cm 60x60x48h
Base: OPM23 Tobacco painted metal
Top: OPP7 Calacatta marble

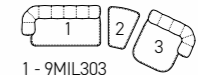

1 - 9MIL303
2 - 9MIL112
3 - 9MIL102



MILO composition cm 350x142
Fabric: cat. D/E clusione 16

Extra cushions:
2 x 9CU104 cm 60x60
1 x 9CU106 cm 45x45
Fabric: cat. D/E clusione 16

KOFI coffee table:
7KO202 cm 90x90x28h
Base: OPM20 Délabré brass brushed metal
Top: OPV9 chrome back-painted bronze glass

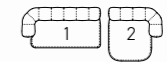

1 - 9MIL303
2 - 9MIL102



MOON ottoman
9MN102 ø cm 60x40h

Fabric: Zimmer
+ Rohde Ardecora Giardino d'Inverno 15487 294
Base: OPM15 antique gold brushed metal

ATENE coffee table
7AT102 ø cm 50x50h
Top: OPP9 Black and Gold marble
Base: OPM15 antique gold brushed metal

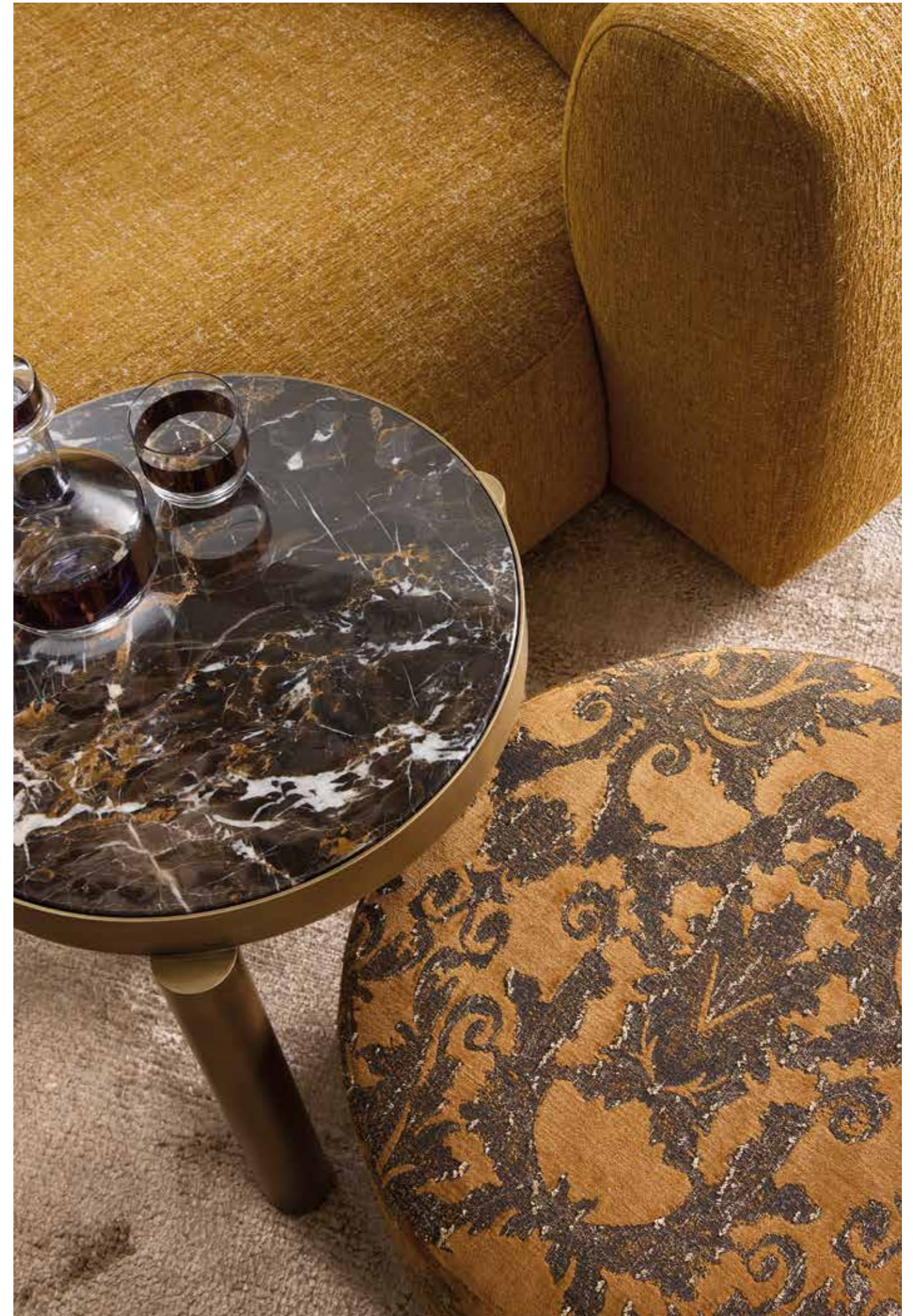



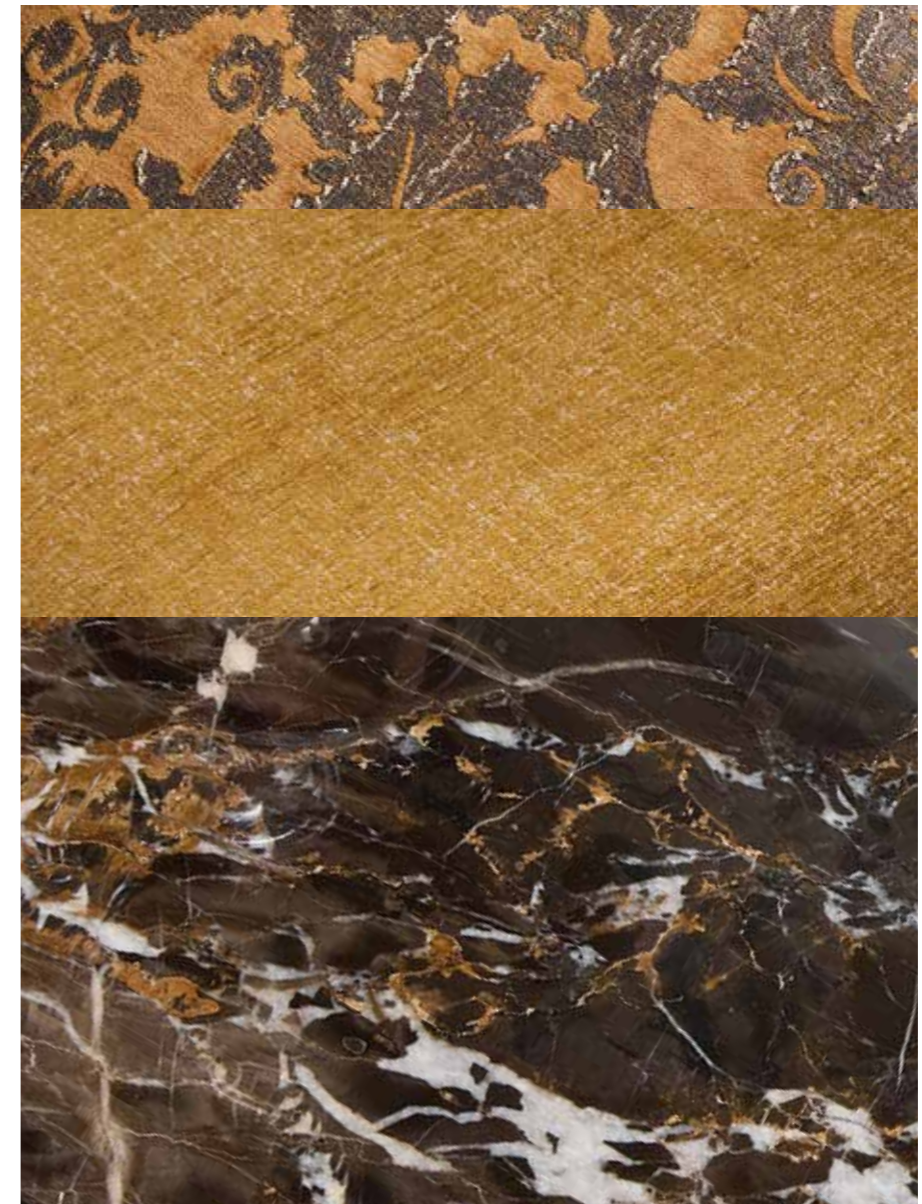

- 1 - 9MIL303
- 2 - 9MIL112
- 3 - 9MIL102

MIL0 composition in fabric cat. F/G art. Orsetto 05/6

WAVE dining table
7WA202 cm 240x110x74h
Base: OPM20 Délabré brass brushed metal
Top: OPP14 Amani bronze marble

CHIA chairs
9CHI104 cm 58x53x77h
Outside: Leather cat. Extra art. Levante 5608
Inside: Fabric cat. F/G art. Alma 4388 1245
Base: OPM15 antique gold brushed metal



CHIA chair**9CHI104 cm 58x53x77h**Outside: Leather cat. Extra art. Levante 5608
Inside: Fabric cat. F/G art. Alma 4388 1245
Base: OPM15 antique gold brushed metal



CHIA chairs
9CHI104 cm 58x53x77h
Outside: Leather cat. Extra art. Levante 5608
Inside: Fabric cat. F/G art. Alma 4388 1245
Base: OPM15 antique gold brushed metal





MIL0 composition cm 208x107
Leather: cat. Extra art. Levante 5608

Cushions:
1 x 9CU104 cm 60x60
Leather: cat. Extra art. Levante 5608

MIL0 composition cm 476x317
Fabric: cat. D/E art. Clusone col. 08

Extra cushions:
2 x 9CU104 cm 40x40
2 x 9CU106 cm 45x45
Fabric: cat. D/E art. Clusone 08
2 x 9CU106 cm 45x45
Fabric: cat. H art. Misia M261 80 1 Ivory
1 x 9CU106 cm 45x45
1 x 9CU104 cm 60x60
Leather: cat. Extra art. Levante 5608

ONNO coffee tables
70N105 cm 120x120x25h
70N102 ø cm 60x35h
70N110 ø cm 90x25h
70N101 cm 60x60x35h
70N104 ø cm 45x45h
Bases: OPR15 moka matt stained oak
+ MDF painted in finish OPM20 Délabré brass brushed

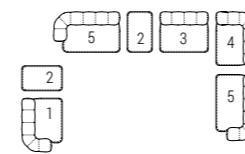

1 - 9MIL301
2 - 9MIL110
3 - 9MIL401
4 - 9MIL203
5 - 9MIL302

MILO composition cm 476x317
Fabric: cat. D/E art. Clusone col. 08

MILO armchair
9MIL101 cm 96x76x70h
Fabric: cat. F/G art. Orsetto 1/1

Extra cushions:
2 x 9CU104 cm 40x40
2 x 9CU106 cm 45x45
Fabric: cat. D/E art. Clusone 08
2 x 9CU106 cm 45x45
Fabric: cat. H art. Misia M261 80 1 Ivory
1 x 9CU106 cm 45x45
1 x 9CU104 cm 60x60
Leather: cat. Extra art. Levante 5608

MILO composition cm 208x107
Leather: cat. Extra art. Levante 5608

Extra cushions:
1 x 9CU104 cm 60x60
Leather: cat. Extra art. Levante 5608

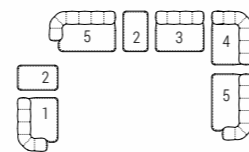

ONNO coffee tables
7ON105 cm 120x120x25h
7ON102 ø cm 60x35h
7ON110 ø cm 90x25h
7ON101 cm 60x60x35h
7ON104 ø cm 45x45h
Bases: OPR15 moka matt stained oak
+ MDF painted in finish OPM20 Délabré brass brushed
Top: OPP7 Calacatta marble

1 - 9MIL301
2 - 9MIL110
3 - 9MIL401
4 - 9MIL203
5 - 9MIL302



Details of MILO sofa

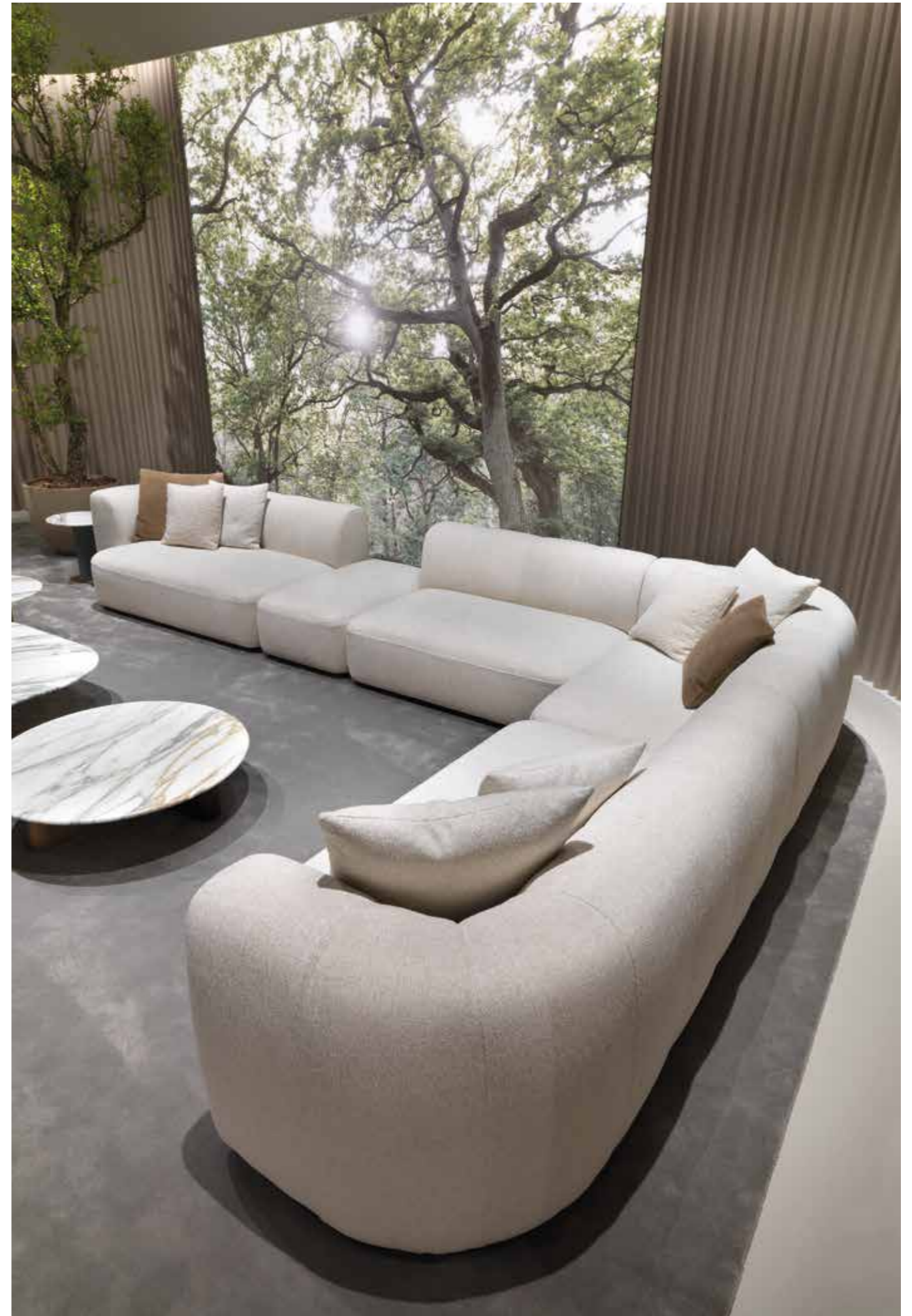

MIL0 composition **cm 350x107x70h**
Fabric: cat. D/E art. Clusone 08

Extra cushions:

1 x 9CU104 cm 60x60

Leather: cat. Extra art. Levante 5608

1 x 9CU104 cm 60x60

1 x 9CU106 cm 45x45

Fabric: cat. D/E art. Clusone 08

1 x 9CU106 cm 45x45

Fabric: cat. H art. Misia M261 80 1 Ivory

ONNO coffee tables

7ON110 ø cm 90x25h

7ON101 cm 60x60x35h

Bases: OPR15 moka matt stained oak

+ MDF painted in finish OPM20 Délabré brass brushed

Top: OPP7 Calacatta marble

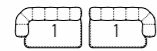

1 - 9MIL302





MILO loveseat
9MIL505 cm 140x158x70h
 Fabric: cat. F/G art. Orsetto 01/1

Extra cushions:
9CU104 cm 60x60
 Fabric: cat. F/G art. Orsetto 01/1
9CU108 cm 55x55
 Fabric: cat. H art. Zimmer + Rohde Mirador 1086 983

KOFI side tables
7KO101 cm 60x60x48h
 Top: OPP2 Marquina black marble
 Base: OPM18 anodyc bronze painted metal



MILO loveseat
9MIL505 cm 140x158x70h
 Fabric: cat. F/G art. Orsetto 01/1

Extra cushions:
2 x 9CU104 cm 60x60
 Fabric: cat. F/G art. Orsetto 01/1

ONNO side tables
7ON103 cm 45x45x45h
 Top: Patagonia marble
 Base: MDF painted in colour RAL 8019
 + OPM15 antique gold brushed metal



KOFI side tables
7K0101 cm 60x60x48h
7K0104 cm 60x60x38h
Top: OPP2 Marquina black marble
Base: OPM18 anodized bronze painted metal





BRERA armchairs
9BRE106 cm 80x82x101h
 Leather: cat. Extra art. Levante 5608
 Base: OPM15 antique gold brushed metal

WAVE side table
7WA101 ø cm 50x47h
 Top: OPP7 Calacatta gold marble
 Base: OPM20 Délabré brass brushed metal



ARTHUR side table
7ART201 ø cm 50x50h
Base: OPM16 shiny brass chrome metal
Top: OPP4 Beige Brera Stone

BRERA armchair with high back
9BRE106 cm 80x82x101h
Fabric: cat. F/G art. Misia Aime M356 308 Lavalliere
Base: OPM15 antique gold brushed metal



BRERA armchair with high back
9BRE106 cm 80x82x101h
Fabric: cat. F/G art. Misia Aime M356 308 Lavalliere
Base: OPM15 antique gold brushed metal

ARTHUR side table
7ART201 ø cm 50x50h
Base: OPM16 shiny brass chrome metal
Top: OPP4 Beige Brera Stone



MILO sofa
9MIL202 cm 255x107x70h
 Leather: Cat. Extra art. Levante 5608

Extra cushions:
2 x 9CU106 cm 45x45
 Fabric: Zimmer + Rohde Rythm 10961/895

MILO armchairs
9MIL101 cm 96x78x70h
 Fabric: Zimmer + Rohde Rythm 10961/895

WAVE coffee tables
7WA104 ø cm 120x27h
7WA102 ø cm 60x37h
7WA101 ø cm 50x47h
 Base: OPM20 délabré brass brushed metal
 Top: OPP7 Calacatta marble



MILO sofa
9MIL202 cm 255x107x70h
9CU106 cm 45x45
9CU104 cm 60x60
Leather: cat. Extra art. Levante 5608

ONNO server table
7ON104 ø cm 45x45h
Top: OPP7 Calacatta marble
Bases: Green painted MDF
+ OPM20 Délabré brass brushed metal





MILO sofa
9MIL202 cm 255x107x70h
 Leather: Cat. Extra art. Levante 5608

WAVE coffee tables
7WA104 ø cm 120x27h
7WA102 ø cm 60x37h
7WA101 ø cm 50x47h
 Base: OPM20 délabré brass brushed metal
 Top: OPP7 Calacatta marble



WAVE coffee table
7WA101 ø cm 50x47h
 Base: OPM20 délabré brass brushed metal
 Top: OPP7 Calacatta marble



AFRA chairs**9AF101 cm 63x59x79h**Fabric: Zimmer + Rohde Nelson 10873/892
Base: OPR5 black stained oak**ONNO dining table****7ON202 cm 260x120x74h**Bases: MDF painted in OPM20 Délabré brass brushed finish
+ OPR5 black painted oak

AFRA chairs
9AF101 cm 63x59x79h
Fabric: Zimmer + Rohde Nelson 10873/892
Base: OPR2 black stained oak







AFRA chairs
9AF101 cm 63x59x79h
Fabric: Zimmer + Rohde Nelson 10873/892
Base: OPR2 black stained oak



NOAH curved sofa
9NH301 cm 250x100x76,5h
NOAH armchair
9NH101 cm 90x90x76,5h
 Fabric: cat. D/E art. Tresigallo 08

Extra cushions:
1 x 9CU106 cm 45x45
 Fabric: cat. D/E art. Tresigallo 08
1 x 9CU106 cm 45x45
 Fabric: cat. F/G art. Misia M188 622 badiane

NOAH sofa
9HN202 cm 250x100x76,5h
 Fabric: cat. H art. Etamine Arles col. 883

Extra cushions:
1 x 9CU106 cm 45x45
1 x 9CU107 cm 25x50
 Fabric: cat. H art. Casamance Lanata 4454 09 60
1 x 9CU106 cm 45x45
 Fabric: cat. D/E art. Tresigallo 08

WAVE coffee tables
7WA104 ø cm 120x27h
7WA102 ø cm 60x37h
7WA101 ø cm 50x47h
 Base: OPM20 Délabré brass brushed metal
 Top: OPP17 Port Laurent marble
7WA122 ø cm 60x37h
 Base + Top: OPM20 Délabré brass brushed metal









NOAH curved sofa
9NH301 cm 250x100x76,5h
 Fabric: cat. D/E art. Tresigallo 08

Extra cushions:
1 x 9CU106 cm 45x45
 Fabric: cat. D/E art. Tresigallo 08
1 x 9CU106 cm 45x45
 Fabric: cat. F/G art. Misia M188 622 badiane



NOAH armchair
9NH101 cm 90x90x76,5h
 Fabric: cat. D/E art. Tresigallo 08





WAVE coffee tables with OPP17 Port Laurent marble top



WAVE dining table
7WA203 cm 280x110x74h
 Base: OPM20 Délabré brass brushed metal
 Top: OPP12 Guatemala green marble

LINDA chairs
9LIN102 cm 62x58x78h
 Fabric: cat. D/E art. Persiano col. 208
 OPM20 Délabré brass brushed metal

THEO sideboard
7THE103 cm 240x55x70h
 Top: OPP13 Velvet brown marble
 Structure: OPR15 moka matt stained oak
 Handles: OPM15 antique gold brushed metal



WAVE dining table**7WA203 cm 280x110x74h**Base: OPM20 Délabré brass brushed metal
Top: OPP12 Guatemala green marble**LINDA chairs****9LIN102 cm 62x58x78h**Fabric: cat. D/E art. Persiano col. 208
Base: OPM20 Délabré brass brushed metal

MOON curved sofas
9MN204 cm 305x120x76h
 Fabric: cat. F/G art. Orsetto 01/1
 Base: OPM21 dark bronze painted metal

Extra cushions:
2 x 9CU104 cm 60x60
 Fabric: cat. F/G art. Orsetto 01/1
1 x 9CU106 cm 45x45
 Fabric: Metaphores St. Germain 71221 046

MOON armchair
9MN101 cm 98x90x76h
 Fabric: Metaphores St. Germain 71221 046
 Base: OPM21 dark bronze painted metal

MOON ottoman
9MN102 ø cm 60x40h
 Fabric: cat. H art. Casamance Nemesia 4320 01 57
 Base: OPM15 antique gold brushed metal

WAVE coffee tables
7WA104 ø cm 120x27h
7WA102 ø cm 60x37h
7WA101 ø cm 50x47h
 Base: OPM18 anodyc bronze painted metal
 Top: OPP7 Calacatta marble





MOON curved sofas
9MN204 cm 305x120x76h
 Fabric: cat. F/G art. Orsetto 01/1
 Base: OPM21 dark bronze painted metal

Extra cushions:
2 x 9CU104 cm 60x60
 Fabric: cat. F/G art. Orsetto 01/1
1 x 9CU106 cm 45x45
 Fabric: Metaphores St. Germain 71221 046





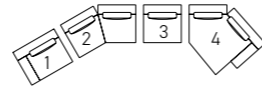

1 - 9YA201
2 - 9YA601
3 - 9YA301
4 - 9YA604

YANN composition cm 695x252
Fabric: cat. D/E art. Nebraska 1592 col. 18

Extra cushions:
4 x 9CU106 cm 45x45
Fabric: cat. D/E art. Nebraska 1592 col. 18
1 x 9CU106 cm 45x45
Fabric: cat. D/E art. Persiano col. 208
1 x 9CU106 cm 45x45
1 x 9CU103 cm 40x40
Fabric: cat. H art. Misia La Flèche d'Or col. M260 701 Sepia

SIGN armchairs
9S1112 cm 83x75x75h
Fabric: Métaphores Toundra Lieges 71405/006
Base: OPM15 antique gold brushed metal

ARTHUR coffee tables
7ART203 ø cm 120x30h
7ART201 ø cm 50x50h
7ART202 ø cm 60x40h
Base: OPM20 Délabré brass brushed metal
Top: OPP7 Calacatta marble

ONNO server table
7ON103 cm 45x45x45h
Top: OPP7 Calacatta marble
Base: OPM20 Délabré brass brushed metal
+ OPM18 anodized bronze painted metal





ARTHUR coffee tables
7ART203 ø cm 120x30h
7ART201 ø cm 50x50h
Base: OPM20 Délabré brass brushed metal
Top: OPP7 Calacatta marble

ONNO server table
70N103 cm 45x45x45h
Top: OPP7 Calacatta marble
Base: OPM20 Délabré brass brushed metal
+ OPM18 anodyc bronze painted metal





Details of YANN composition
in fabric cat. D/E art. Nebraska 1592 col. 18
and decorative cushion in fabric Misia La Flèche D'or col. M260 70 1 Sepia

ARTHUR coffee tables**7ART203** ø cm 120x30h**7ART201** ø cm 50x50h**7ART202** ø cm 60x40hBase: OPM20 Délabré brass brushed metal
Top: OPP7 Calacatta marble**SIGN armchair****9SI112** cm 83x75x75h

Fabric: Metaphores Art. 71405/006 Tundra Lieges

Base: OPM15 antique gold brushed metal



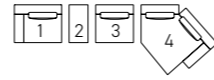

1 - 9YA201
2 - 7YA102
3 - 9YA301
4 - 9YA604

YANN composition cm 459x202
Fabric: cat. D/E art. Nebraska 1592 col. 18

Extra cushions:
4 x 9CU106 cm 45x45
Fabric: cat. D/E art. Nebraska 1592 col. 18
2 x 9CU106 cm 45x45
Fabric: cat. H art. Misia La Flèche d'Or col. M260 701 Sepia
1 x 9CU106 cm 45x45
Fabric: cat. F/G Art. Misia Aime M188 631 Terre d'Ombre

YANN table
7YA104 cm 50x100x24h
MDF painted in finish OPM20 Délabré brass brushed

SIGN armchair
9SI112 cm 83x75x75h
Fabric: cat. F/G Art. Misia Aime M188 631 Terre d'Ombre
Base: OPM15 antique gold brushed metal

KOFI tables
7KO102 cm 90x90x28h
Top: OPP7 Calacatta marble
Base: OPM23 Tobacco painted metal
7KO101 cm 60x60x48h
Top: OPP7 Calacatta marble
Base: OPM20 Délabré brass brushed metal





Detail of **YANN table**
7YA104 cm 50x100x24h
MDF painted in finish OPM20 Délabré brass brushed



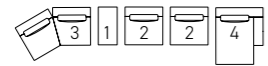

1 - 7YA102
2 - 9YA301
3 - 9YA601
4 - 9YA204



YANN composition cm 423x233
Fabric: cat. F/G art. Casamance Lierna 4976 0327 sable
YANN table
7YA104 cm 50x100x24h
MDF painted in finish OPM20 Délabré brass brushed

Extra cushions:
3 x 9CU106 cm 45x45
Fabric: cat. F/G art. Casamance Lierna 4976 0327 sable
2 x 9CU106 cm 45x45
Fabric: cat. F/G art. Misia Aime M188 631 Terre d'ombre
2 x 9CU106 cm 45x45
Fabric: cat. D/E art. Persiano col. 208



KOFI coffee tables**7K0102 cm 90x90x28h**

Base: OPM23 Tobacco painted metal

Top: OPP7 Calacatta marble

7K0101 cm 60x60x48h

Base: OPM20 Délabré brass brushed metal

Top: OPP7 Calacatta marble





JEFF sofa
9JE204 cm 230x120x66h
 Fabric: cat. D/E art. Clusone 08
 Base: OPM15 antique gold brushed metal

BREAK side tables
7BR102 ø cm 60x36h
 Base: OPM15 antique gold brushed metal
 Top: OPP3 Emperador brown marble
7BR117 ø cm 40x45h
 Base: OPM17 bronze metal
 Top: OPV12 transparent bronze glass

JEFF sofa
9JE202 cm 225x87x66h
 Fabric: cat. F/G art. Misia Aime M356 308 Lavalliere
 Base: OPM15 antique gold brushed metal

ATENE coffee tables
7AT104 ø cm 100x30h
7AT101 ø cm 50x40h
 Base: OPM17 bronze metal
 Top: OPP3 Emperador brown marble

JEFF armchair
9JE101 cm 100x87x66h
 Leather: cat. Lusso art. Nabuk C/3407 mogano
 Base: OPM18 anodyc bronze painted metal



JEFF sofa
9JE202 cm 225x87x66h
 Fabric: cat.F/G art.Misia Aime M356 308 Lavalliere
 Base: OPM15 antique gold brushed metal

TWIG coffee tables
7TG103 ø cm 100x35h
 Base: OPM16 shiny brass chrome metal
 Top: OPP3 Emperdor brown marble
7TG101 ø cm 50x50h
 Base: OPM16 polished brass
 Top: OPP13 Velvet brown marble

JEFF armchairs
9JE101 cm 100x87x66h
 Leather: cat.Lusso art Nabuk c/3407 mogano
 Base: OPm18 anodyc bronze painted metal





MOON ottomans
9MN102 ø cm 60x40h
 Fabrics: Misia Niki M347 501 mordoré
 Casamance Ferveur 4612 1179
 Base: OPM15 antique gold brushed metal

BREAK side table
7BR117 ø cm 40x45h
 Base: OPM17 bronze metal
 Top: OPV12 transparent bronze glass





JEFF armchairs 9JE101 cm 100x87x66h
Leather: cat. Lusso art. Nabuk C/3407 mogano
Base: OPM18 anodized bronze painted metal



JEFF sofa 9JE204 cm 230x120x66h
Fabric: cat. D/E art. Clusone 08
Base: OPM15 antique gold brushed metal

ATENE coffee tables
7AT104 ø cm 100x30h
Base: OPM17 bronze metal
Top: OPP3 Emperador brown marble

Detail of **JEFF sofa**
in fabric cat. D/E art. Clusone 08





MOON ottomans
9MN102 ø cm 60x40h
 Fabrics: Misia Niki M347 501 mordoré
 Casamance Ferveur 4612 1179
 Base: OPM15 antique gold brushed metal

BREAK side table
7BR117 ø cm 40x45h
 Base: OPM17 bronze metal
 Top: OPV12 transparent bronze glass

JEFF sofa
9JE204 cm 230x120x66h
 Fabric: cat. D/E art. Clusone 08
 Base: OPM15 antique gold brushed metal







JEFF sofa
9JF204 cm 230x120x80h
 Fabric: cat.D/E art.Clusone 09
 Base: OPM15 antique gold brushed metal

TWIG coffee tables
7TG103 ø cm 100x35h
 Base: OPM16 shiny brass chrome metal
 Top: OPP3 Emperdor brown marble
7TG101 ø cm 50x50h
 Base: OPM16 polished brass
 Top: OPP13 Velvet brown marble

JEFF curved sofa
9JE203 cm 250x95x66h
 Fabric: Zimmer + Rhode Okapi 21 285 486
 Base: OPM15 antique gold brushed metal

JEFF curved sofa
9JE203 cm 250x95x66h
Fabric: Zimmer + Rohde Okapi 21285 486
Base: OPM15 antique gold brushed metal



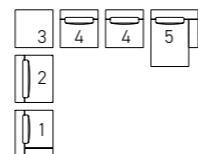

1 - 9YA201
 2 - 9YA302
 3 - 9YA103
 4 - 9YA301
 5 - 9YA204

YANN composition cm 425x350
 Fabric: cat. D/E art. Brasilia 04

Extra cushions:
2 x 9CU106 cm 45x45
 Fabric: cat. F/G art. Misia Aime M188 420 cuivre
2 x 9CU108 cm 55x55
 Fabric: cat. H Zimmer + Rohde Mirador 1086 983

MOON ottoman 9MN102 ø cm 60x40h
 Fabric: cat. H Zimmer + Rohde Mirador 1086 983
 Base: OPM15 antique gold brushed metal

WAVE coffee tables
7WA104 ø cm 120x27h
7WA102 ø cm 60x37h
7WA101 ø cm 50x47h
 Base: OPM19 Délabré pewter brushed metal
 Top: OPP13 Velvet brown marble
7WA121 ø cm 50x47h
 Base and top: OPM19 Délabré pewter brushed metal

THEO sideboard
7THE103 cm 240x55x70h
 Top: OPP13 Velvet brown marble
 Structure: OPR15 moka matt stained oak
 Handles: OPM15 antique gold brushed metal





YANN composition
in fabric cat. D/E art. Brasilia 04

MOON ottoman
9MN102 ø cm 60x40h
Fabric: cat. H Zimmer + Rohde Mirador 1086 983
Base: OPM15 antique gold brushed metal

WAVE coffee table
7WA101 ø cm 50x47h
Base: OPM19 Délabré pewter brushed metal
Top: OPP13 Velvet brown marble



Detail of cushion in fabric Zimmer
+ Rohde Mirador 1086 983

WAVE coffee tables**7WA104** ø cm 120x27h**7WA101** ø cm 50x47h

Base: OPM20 Délabré brass brushed metal

Top: OPP7 Calacatta marble

7WA112 ø cm 60x37h

Base: OPM20 Délabré brass brushed metal

Top: RAL 7006 back-painted glass

**YANN composition**
in fabric cat. D/E art. Brasilia 04**YANN table****9YA103** cm100x100x24

in OPM20 Délabré brass brushed finish

THEO sideboard**7THE103** cm 240x55x70h

Top: OPP13 Velvet brown marble

Structure: OPR15 moka matt stained oak

Handles: OPM15 antique gold brushed metal



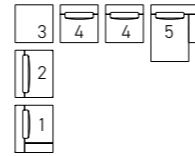

1 - 9YA201
2 - 9YA302
3 - 9YA103
4 - 9YA301
5 - 9YA204

YANN composition cm 450x350
Fabric: cat. D/E art. Brasilia 04

Extra cushions:
2 x 9CU106 cm 45x45
Fabric: cat. F/G art. Misia Aime M188 420 cuivre
2 x 9CU108 cm 55x55
Fabric: cat. H Zimmer + Rohde Mirador 1086 983

MOON ottoman 9MN102 ø cm 60x40h
Fabric: cat. H Zimmer + Rohde Mirador 1086 983
Base: OPM15 antique gold brushed metal

WAVE coffee tables
7WA104 ø cm 120x27h
7WA102 ø cm 60x37h
7WA101 ø cm 50x47h
Base: OPM19 Délabré pewter brushed metal
Top: OPP13 Velvet brown marble
7WA121 ø cm 50x47h
Base and top: OPM19 Délabré pewter brushed metal

THEO sideboard
7THE103 cm 240x55x70h
Top: OPP13 Velvet brown marble
Structure: OPR15 moka matt stained oak
Handles: OPM15 antique gold brushed metal





THEO sideboard
7THE103 cm 240x55x70h
 Top: OPP13 Velvet brown marble
 Structure: OPR15 moka matt stained oak
 Handles: OPM15 antique gold brushed metal



ATACAMA sofas
9ATC101 cm 225x145x80h
9ATC102 cm 225x145x80h
Fabric: cat. F/G art. Orsetto 01/1

ATACAMA ottomans
9ATC108 cm 85x75x44h
Fabric: cat. F/G art. Orsetto 01/1
OPV9 chrome back-painted bronze glass

WAVE tables
7WA104 ø cm 120x27h
7WA102 ø cm 60x37h
Top: OPP7 Calacatta marble
Base: OPM20 Délabré brass brushed metal







Details of **ATACAMA sofas**
in fabric cat. F/G art. Orsetto 01/1



ATACAMA sofas
9ATC101 cm 225x145x80h
9ATC102 cm 225x145x80h
9ATC103 cm 185x105x80h
 Fabric: cat. F/G art. Orsetto 01/1

ATACAMA ottomans
9ATC108 cm 85x75x44h
 Fabric: cat. F/G art. Orsetto 01/1
 OPV9 chrome back-painted bronze glass

WAVE tables
7WA104 ø cm 120x27h
7WA102 ø cm 60x37h
7WA101 ø cm 50x50h
 Top: OPP7 Calacatta marble
 Base: OPM20 Délabré brass brushed metal

ONNO bookshelf
7ON301 cm 200x38x198h
 OPR15 moka matt stained oak tops
 Matt beige painted MDF elements





ONNO bookshelf
70N301 cm 200x38x198h
 OPR15 moka matt stained oak tops
 Matt beige painted MDF elements

WAVE tables
7WA104 ø cm 120x27h
7WA102 ø cm 60x37h
 Top: OPP7 Calacatta marble
 Base: OPM20 Délabré brass brushed metal





ATACAMA sofas
9ATC101 cm 225x145x80h
Fabric: cat. D/E art. Jurga col. 22

ARTHUR tables
7ART204 ø cm 100x30h
7ART202 ø cm 60x40h
Top: OPP5 Beige Brera Stone
Base: OPM15 antique gold brushed metal



ATACAMA sofas
9ATC101 cm 225x145x80h
 Fabric: cat. D/E art. Jurga col. 22

ARTHUR tables
7ART204 ø cm 100x30h
7ART202 ø cm 60x40h
 Top: OPP5 Beige Brera Stone
 Base: OPM15 antique gold brushed metal





MOON armchair
9MN101 cm 98x90x76h
 Fabric: cat. D/E art. Tresigallo 01
 Base: OPM21 dark bronze painted metal

MOON composition cm 451x185 made of:
 Bespoke side element **cm 226x90x76h**
 Curved chaise longue **9MN211 cm 225x185x76h**

Extra cushions:
2 x 9CU106 cm 45x45
1 x 9CU103 cm 40x40
 Fabric: cat. F/G art. Quiche col. 19
1 x 9CU105 cm 55x55
 Fabric: cat. H art. Zimmer + Rohde Mirador 1086 983
1 x 9CU106 cm 45x45
 Fabric: cat. F/G art. Misia Aime M188 631 Terre d'Ombre

ARTHUR coffee tables
7ART203 ø cm 120x30h
7ART202 ø cm 60x40h
 Top: OPP7 Calacatta marble
 Base: OPM20 Délabré brass brushed metal

MOON ottomans
9MN102 ø cm 60x40 h
 Fabric: cat. H art. Zimmer + Rohde Mirador 1086 983
 Base: OPM15 antique gold brushed metal
 Fabric: cat. F/G art. Quiche col. 19
 Base: OPM15 antique gold brushed metal



MOON ottomans
9MN102 ø cm 60x40 h
 Fabric: cat. H art. Zimmer + Rohde Mirador 1086 983
 Base: OPM15 antique gold brushed metal
 Fabric: cat. F/G art. Quiche col. 19
 Base: OPM15 antique gold brushed metal

ARTHUR coffee tables
7ART203 ø cm 120x30h
7ART202 ø cm 60x40h
 Top: OPP7 Calacatta marble
 Base: OPM20 Délabré brass brushed metal

MOON composition cm 426x185
 Fabric: cat. F/G art. Quiche col. 19
 Base: OPM21 dark bronze painted metal

Extra cushions:
2 x 9CU106 cm 45x45
1 x 9CU103 cm 40x40
 Fabric: cat. F/G art. Quiche col. 19
1 x 9CU105 cm 55x55
 Fabric: cat. H art. Zimmer + Rohde Mirador 1086 983
1 x 9CU106 cm 45x45
 Fabric: cat. F/G art. Misia Aime M188 631 Terre d'Ombre







NOAH left chaise longue
9NH102 cm 220x115x76,5h

Extra cushions:
1 x 9CU105 cm 50x50
1 x 9CU103 cm 40x40
 Fabric: cat. F/G art. Misia Aime M356 5 10

NOAH armchair
9NH101 cm 90x90x76,5h

LUA coffee tables
7LU203 ø cm 60x48h
 Bases: shiny beige painted MDF
 Top: OPP7 Calacatta marble
7LU205 ø cm 120x25h
 Bases OPM20 Délabré brass painted MDF
 Top: OPP7 Calacatta marble

**LUA coffee tables****7LU203 ø cm 60x48h**

Bases: shiny beige painted MDF

Top: OPP7 Calacatta marble

7LU202 ø cm 60x35h

Base: OPM20 Délabré brass painted MDF

Top: OPP7 Calacatta marble

7LU201 ø cm 60x25h

Base: Shiny beige painted MDF

Top: OPP7 Calacatta marble





NOAH left chaise longue
9NH102 cm 220x115x76,5h

Extra cushions:
1 x 9CU105 cm 50x50
1 x 9CU103 cm 40x40
 Fabric: cat. F/G art. Misia Aime M356 5 10

LUA coffee tables
7LU203 ø cm 60x48h
 Bases: shiny beige painted MDF
 Top: OPP7 Calacatta marble
7LU205 ø cm 120x25h
 Bases:OPM20 Délabré brass painted MDF
 Top: OPP7 Calacatta marble

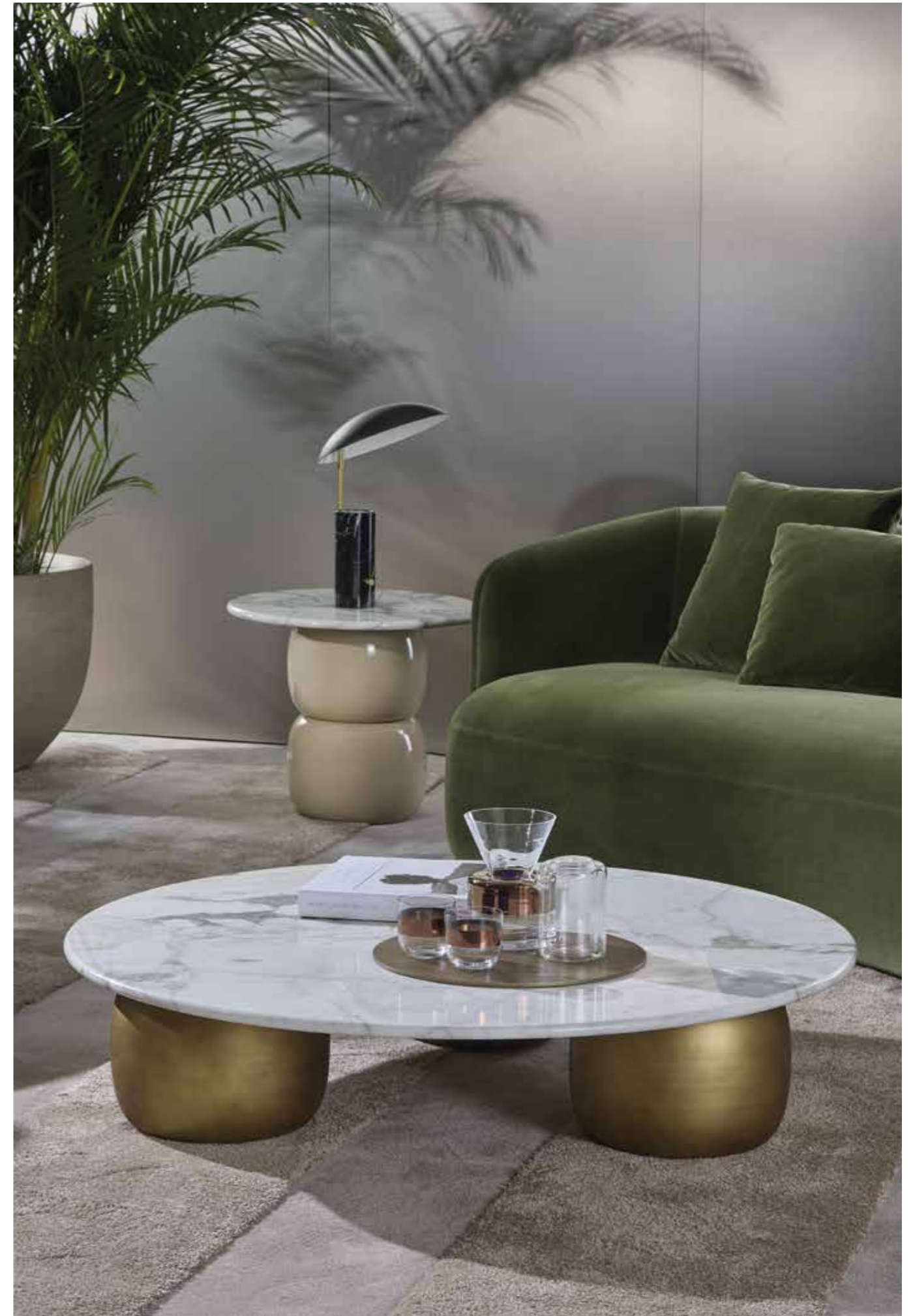

JEFF sofas
9JE203 cm 240x95x80h
9JE205 cm 230x120x80h
Fabric: cat. D/E art. Clusone 08
Base: OPM18 anodyc bronze painted metal

ATENE coffee tables
7AT105 ø cm 120x30h
2 x 7AT102 ø cm 50x50h
Base: OPM15 antique gold brushed metal
Top: OPP12 Guatemala green marble





JEFF sofa
9JE203 cm 240x95x80h
 Fabric: cat. D/E art. Clusone 08
 Base: OPM18 anodized bronze painted metal

Extra cushions:
1 x 9JE102 cm 45x45
 Fabric: cat. F/G art. Misia Aime M356 308 Lavalliere

ATENE coffee table
7AT102 ø cm 50x50h
 Base: OPM15 antique gold brushed metal
 Top: OPP12 Guatemala green marble





ONNO bookshelf
70N301 cm 200x38x198h
OPR15 moka matt stained oak tops
Green painted MDF elements







JEFF sofa
9JE205 cm 230x120x80h
 Fabric: cat. D/E art. Clusone 08
 Base: OPM18 anodized bronze painted metal

ATENE coffee tables
7AT105 ø cm 120x30h
7AT102 ø cm 50x50h
 Base: OPM15 antique gold brushed metal
 Top: OPP12 Guatemala green marble





WAVE round dining table
7WA206 ø cm 180x74h
Base: MDF painted in OPM18 anodized bronze finishing
Top: OPP7 Calacatta marble

BEA small armchairs
9BEA102X cm 59x61x83h
Outside: Fabric cat. H art. Rubelli Vello D'Oro 30085/002 sabbia
Inside: Fabric cat. F/G art. Kieffer by Rubelli Velours Soleil 17189 004 Platre





BEA small armchairs
9BEA102X cm 59x61x83h
 Outside: Fabric cat. H art. Rubelli Vello D'Oro 30085/002 sabbia
 Inside: Fabric cat. F/G art. Kieffer by Rubelli Velours Soleil 17189 004 Platre

JOY swivel base
9JY101 cm 75x82x99h
 Leather cat. Extra art. Levante 5608
 Base: OPM15 antique gold brushed metal

KYOTO sideboards
7KY209 cm 100x50x125h
 Structure: OPR15 moka matt stained oak
 Top: OPP13 Velvet brown marble
 Base: OPM17 bronze metal

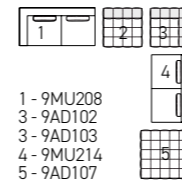

ANDY + MATHEUS composition cm 400x405 made of:
9MU208 side element
9MU214 central element
 Fabric: cat. H art. Rubelli Spritz col. 11 ambra
 Base: OPM18 anodyc bronze painted metal
9AD102 central element
9AD103 side element with back and armrest
 Leather: cat. Lusso art. Nabuk col. C/3407 mogano
 Base: OPM18 anodyc bronze painted metal

Extra cushion:
1 x cushion 9CU108 cm 55x55
 Fabric: cat. H art. Rubelli Spritz col. 11 ambra
1 x cushion 9CU105 cm 50x50
 Fabric: cat. H art. Rubelli Spritz col. 07 castagna
1 x cushion 9CU106 cm 45x45
 Fabric: Zimmer + Rohde Rythm 10961/895

WAVE coffee tables
7WA104 ø cm 120x27h
7WA101 ø cm 50x47h
7WA102 ø cm 60x37h
 Top: OPP3 Emperador brown marble
 Base: OPM20 Délabré brass brushed metal
7WA112 ø cm 60x37h
 OPM19 Délabré pewter brushed metal





ANDY + MATHEUS composition cm 400x405 made of:
9MU208 side element
9MU214 central element
 Fabric: cat. H art. Rubelli Spritz col. 11 ambra
 Base: OPM18 anodyc bronze painted metal
9AD102 central element
9AD103 side element with back and armrest
 Leather: cat. Lusso art. Nabuk col. C/3407 mogano
 Base: OPM18 anodyc bronze painted metal

Extra cushion:
1 x cushion 9CU108 cm 55x55
 Fabric: cat. H art. Rubelli Spritz col. 11 ambra
1 x cushion 9CU105 cm 50x50
 Fabric: cat. H art. Rubelli Spritz col. 07 castagna
1 x cushion 9CU106 cm 45x45
 Fabric: Zimmer + Rohde Rythm 10961/895

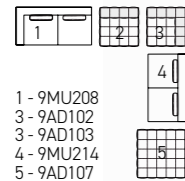

1 - 9MU208
 3 - 9AD102
 3 - 9AD103
 4 - 9MU214
 5 - 9AD107

WAVE coffee tables
7WA104 ø cm 120x27h
7WA101 ø cm 50x47h
7WA102 ø cm 60x37h

Top: OPP3 Emperador brown marble
 Base: OPM20 Délabré brass brushed metal
7WA112 ø cm 60x37h
 OPM19 Délabré pewter brushed metal

JOY swivel base
9JY101 cm 75x82x99h
 Leather cat. Extra art. Levante 5608
 Base: OPM15 antique gold brushed metal



WAVE coffee tables
7WA104 ø cm 120x27h
7WA101 ø cm 50x47h
7WA102 ø cm 60x37h
Top: OPP3 Emperador brown marble
Base: OPM20 Délabré brass brushed metal







JOY swivel base
9JY101 cm 75x82x99h
Leather cat. Extra art. Levante 5608
Base: OPM15 antique gold brushed metal





KYOTO sideboards
7KY209 cm 100x50x125h
 Structure: OPR15 moka matt stained oak
 Top: OPP13 Velvet brown marble
 Base: OPM17 bronze metal

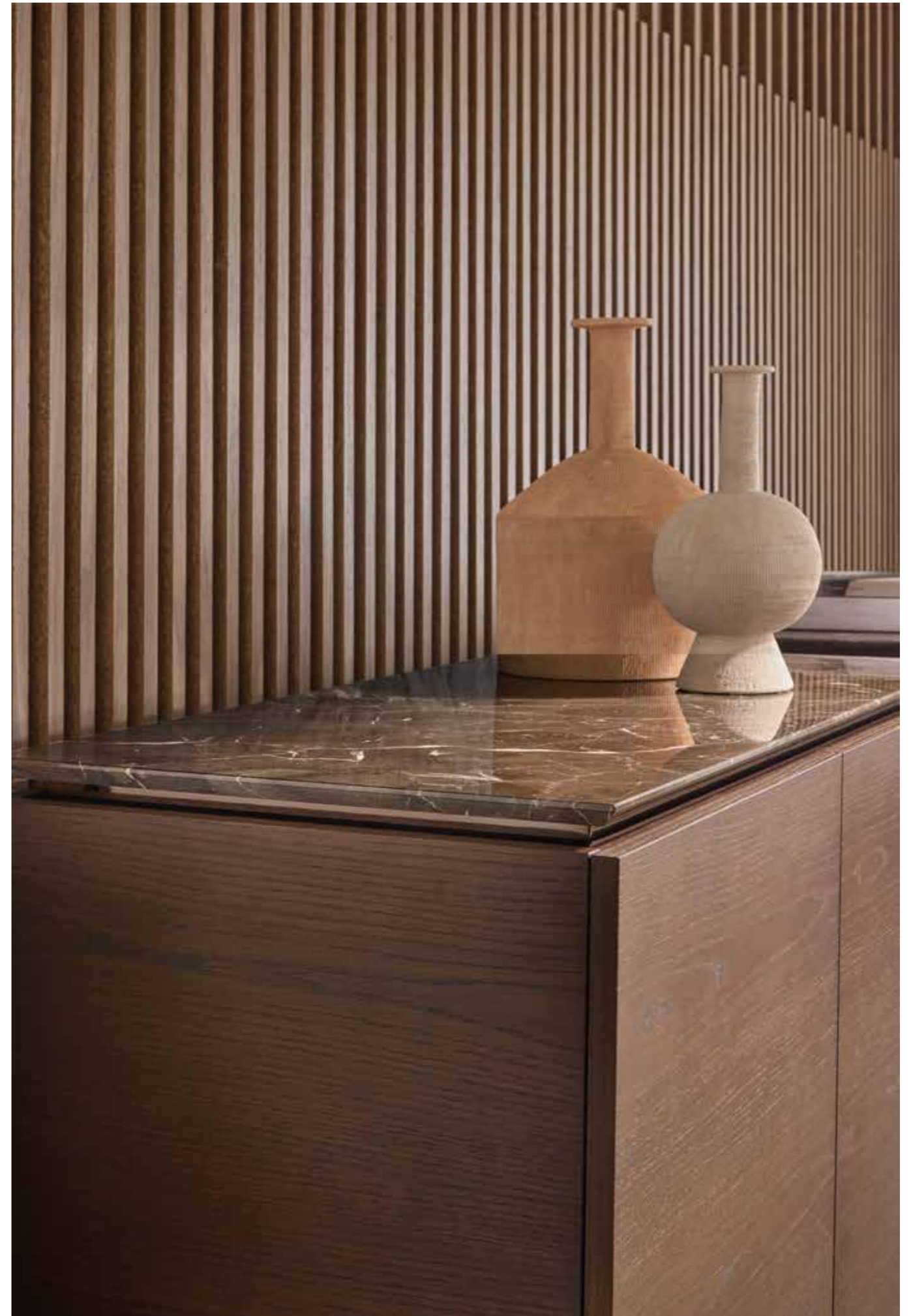

HEBO dining table
7HEB103 cm 260x120x72h
OPP1 Carrara white marble

LINDA chairs
9LIN102 cm 62x58x78h
Leather: cat. Extra art. Lord 9110
Base: OPM15 antique gold brushed metal

KYOTO sideboard
7KY212 cm 220x50x71h
Base: OPM15 antique gold brushed metal
Top: OPP1 Carrara white marble
Structure: OPR11 charcoal stained oak







Details of **HEBO table**
in OPP1 Carrara white marble
and **LINDA chairs** in leather cat. Extra art. Lord 9110







LINDA chairs
9LIN102 cm 62x58x78h
Leather: cat. Extra art. Lord 9110
Base: OPM15 antique gold brushed metal





MILO bed with storage base
5MIL202 cm 180x235x90h
Fabric: cat. F/G art. Orsetto 01/1

ARNOLD bedside table
7ARN101 cm 45x46x38h
Structure: MDF painted in OPM18 anodized bronze finishing
Drawers front: OPP20 Arabescato orobico grey marble

ONNO table
7ON107 cm 150x60x25h
Top: OPP20 Arabescato orobico grey marble
Base: MDF painted in OPM18 anodized bronze finishing





MILO bed with storage base
5MIL202 cm 180x235x90h
 Fabric: cat. F/G art. Orsetto 01/1

ARNOLD bedside table
7ARN101 cm 45x46x38h
 Structure: MDF painted in OPM18 anodyc bronze finishing
 Drawers front: OPP20 Arabescato orobico grey marble

ONNO table
7ON107 cm 150x60x25h
 Top: OPP20 Arabescato orobico grey marble
 Base: MDF painted in OPM18 anodyc bronze finishing

THEO sideboard
7THE106 cm 240x55x70h
 Structure: OPR15 moka matt stained oak
 Top: OPP20 Arabescato orobico grey marble
 Handles: OPM15 antique gold brushed metal



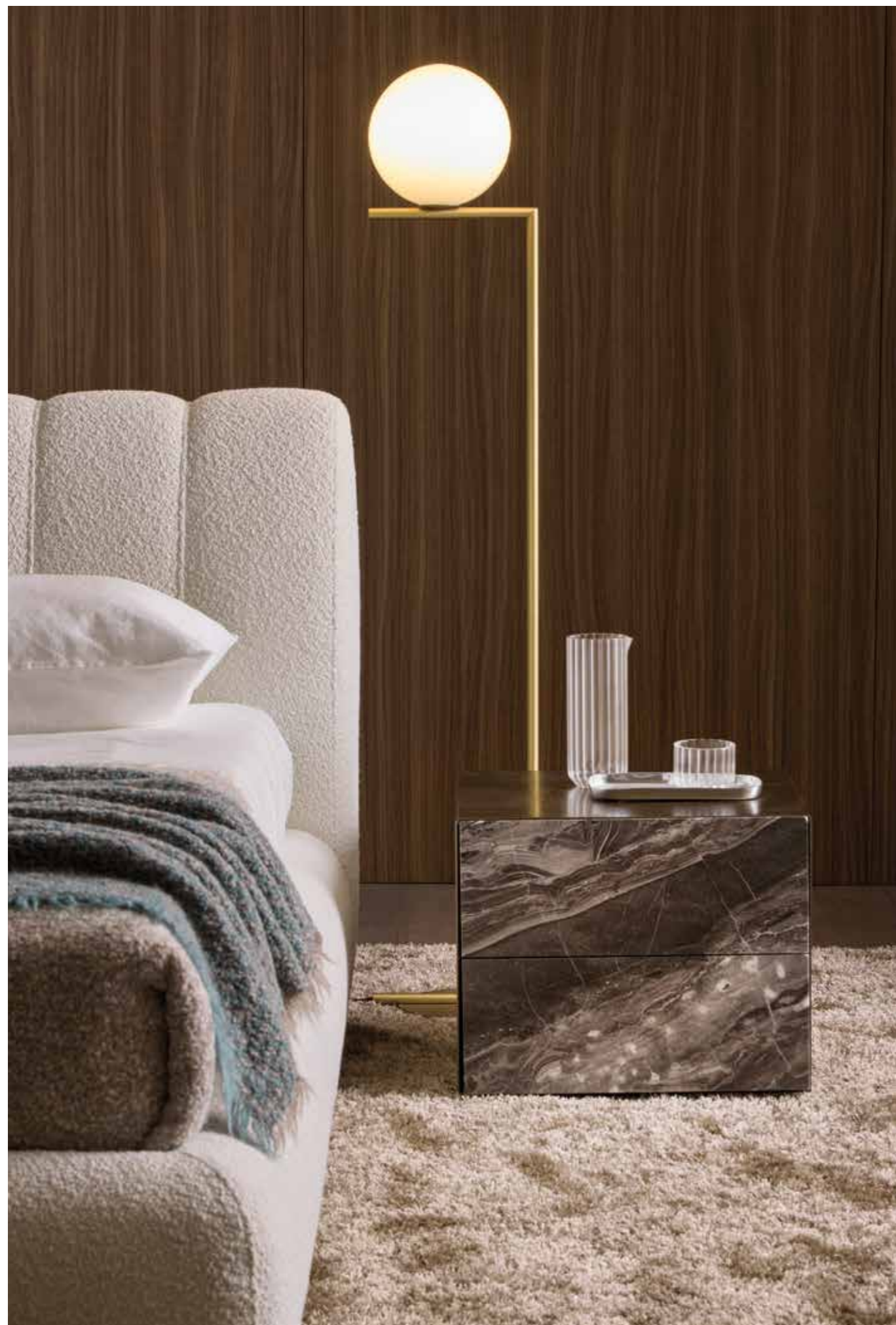

MILO bed with storage base
5MIL202 cm 180x235x90h
 Fabric: cat. F/G art. Orsetto 01/1

ARNOLD bedside table
7ARN101 cm 45x46x38h
 Structure: MDF painted in OPM18 anodyc bronze finishing
 Drawers front: OPP20 Arabescato orobico grey marble



MOON ottoman
ø cm 60x40h
Fabric: cat. H art. Misia Cinq Terres M284 4 04 Vert Olive
Base: OPM15 antique gold brushed metal

NOAH bed with storage base
5NOA202 cm 220x220x120h
Leather: cat. Lusso art. Nabuk C/3403

ONNO bedside tables
7ON303 ø cm 50x50h
Bases: OPR15 moka matt stained oak + matt beige painted MDF
Top: OPP7 Calacatta marble







ONNO bedside table
70N303 ø cm 50x50h
Bases: OPR15 moka matt stained oak + matt beige painted MDF
Top: OPP7 Calacatta marble



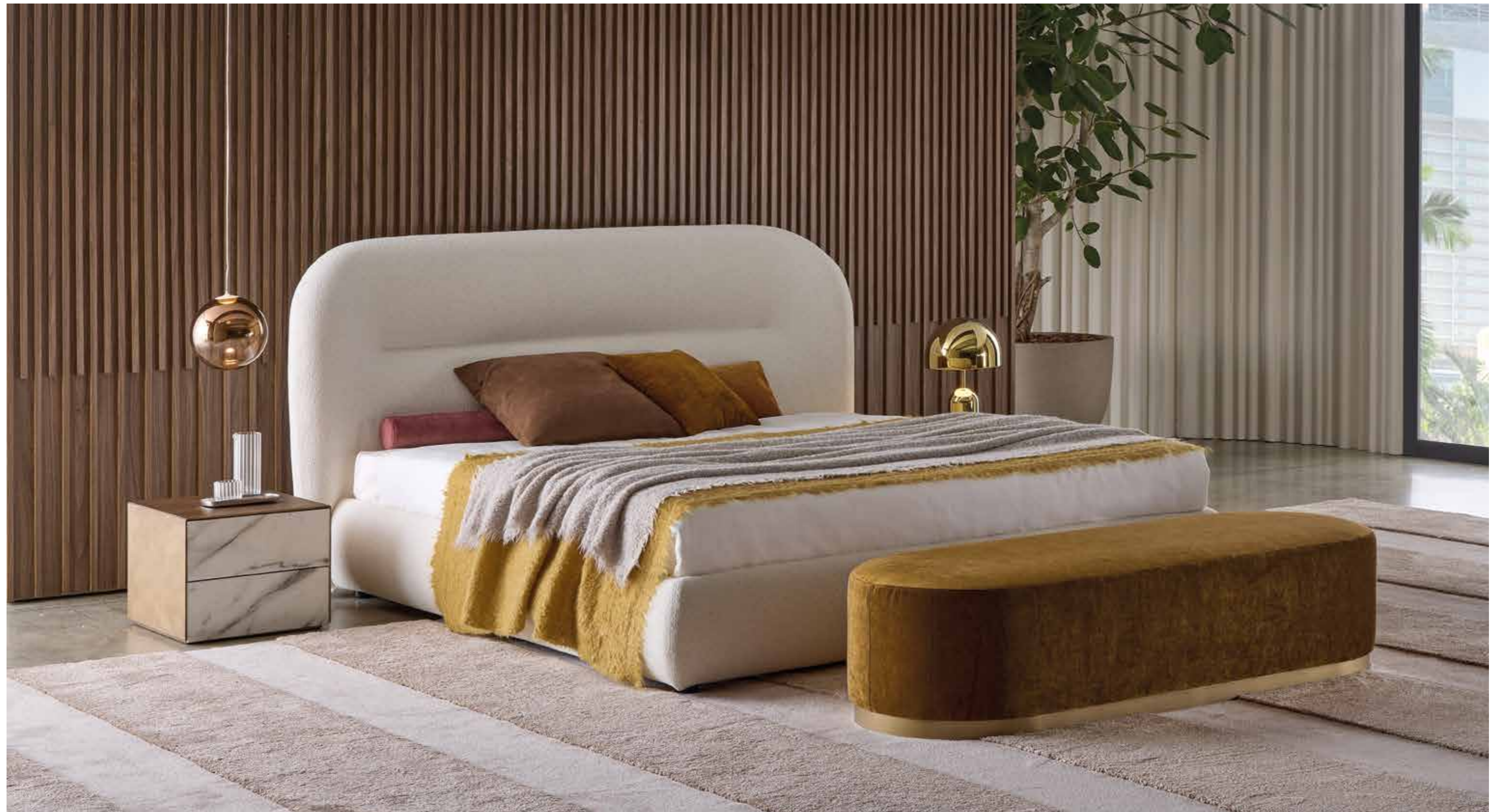

NOAH bed
5NOA102 cm 220x220x120h
 Fabric: cat. F/G art. Orsetto 01/1

Extra cushions:
1 x 9CU106 cm 45x45
 Fabric: cat. F/G art. Misia M188 622 badiane
1 x 9CU107 cm 25x50
 Fabric: cat. H art. Casamance Lanata 4454 09 60
1 x Roller cushion 9ROL101 ø cm 10x58h
 Fabric: cat. H art. Casamance Manade B4248 1836
1 x 9CU108 cm 55x55
 Leather: cat.

MOON bench
9MN104 cm 160x60x40h
 Fabric: cat. H art. Designers Guild Glenville F1872-36 honey
 Base: OPM15 antique gold brushed metal

ARNOLD bedside table with drawers
7GE203 cm 45x46x38h
 Structure: MDF painted in finishing OPM20 Délabré brass brushed
 Drawers front: OPP7 Calacatta marble



NOAH bed
5NOA102 cm 220x220x120h
 Fabric: cat. F/G art. Orsetto 01/1

ARNOLD bedside table with drawers
7GE203 cm 45x46x38h
 Structure: MDF painted in finishing OPM20
 Délabré brass brushed
 Drawers front: OPP7 Calacatta marble

ARNOLD bedside table with drawers
7GE203 cm 45x46x38h
Structure: MDF painted in finishing OPM20 Délabré brass brushed
Drawers front: OPP7 Calacatta marble











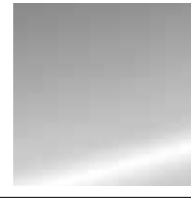

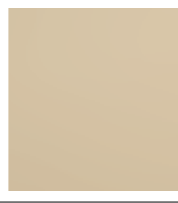



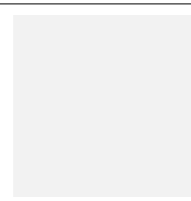

Colori e finiture

COLOURS AND FINISHES

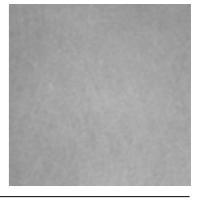
Finiture metallo _ METAL FINISHES _

<p>OPM1 Metallo cromo lucido <i>Shiny chrome metal</i> Metall glänzend verchromt Métal chromé brillant</p>		<p>OPM9 Metallo verniciato classic bronze <i>Classic bronze painted metal</i> Metall classic bronze lackiert Métal laqué classic bronze</p>	
<p>OPM2 Metallo spazzolato cromo satinato <i>Brushed matt chrome metal</i> Metall matt verchromt (gebürstet) Métal chromé mat (brossé)</p>		<p>OPM10 Metallo verniciato golden beach <i>Golden beach painted metal</i> Metall golden beach lackiert Métal laqué golden beach</p>	
<p>OPM3 Metallo spazzolato canna di fucile <i>Brushed matt dark grey metal</i> Metall dunkelgrau gebürstet Métal brossé canon de fusil</p>		<p>OPM11 Metallo verniciato gold pearl <i>Gold pearl painted metal</i> Metall gold pearl lackiert Métal laqué gold pearl</p>	
<p>OPM6 Metallo verniciato RAL 9017 nero <i>RAL 9017 black painted metal</i> Metall RAL 9017 schwarz lackiert Métal laqué noir RAL 9017</p>		<p>OPM12 Metallo spazzolato rame <i>Brushed copper metal</i> Metall Kupfer gebürstet Métal brossé cuivre</p>	
<p>OPM7 Metallo verniciato RAL 9016 bianco <i>RAL 9016 white painted metal</i> Metall RAL 9016 weiss lackiert Métal laqué blanc RAL 9016</p>		<p>OPM13 Metallo spazzolato ottone antico <i>Brushed antique brass metal</i> Metall Antik Messing gebürstet Métal brossé laiton antique</p>	



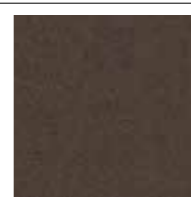





Finiture metallo _ METAL FINISHES _

<p>OPM14 Metallo cromo nero lucido <i>Shiny black chrome metal</i> Metall schwarz glänzend verchromt Métal chromé noir brillant</p>		<p>OPM19 Metallo spazzolato peltro Délabré <i>Délabré pewter brushed metal</i> Metall Zinn délabré gebürstet Métal brossé étain délabré</p>	
<p>OPM15 Metallo spazzolato oro antico <i>Brushed antique gold metal</i> Metall Antik gold gebürstet Métal brossé or antique</p>		<p>OPM20 Metallo spazzolato ottone Délabré <i>Délabré brass brushed metal</i> Metall Messing délabré gebürstet Métal brossé laiton délabré</p>	
<p>OPM16 Metallo cromo ottone lucido <i>Shiny brass chrome metal</i> Metall Messing glänzend verchromt Métal chromé laiton brillant</p>		<p>OPM21 Metallo verniciato bronzo scuro <i>Dark bronze painted metal</i> Metall dunkelbronze lackiert Métal laqué bronze foncé</p>	
<p>OPM17 Metallo cromo bronzo lucido <i>Shiny bronze chrome metal</i> Metall bronze glänzend verchromt Métal chromé bronze brillant</p>		<p>OPM22 Metallo verniciato prosecco <i>Prosecco painted metal</i> Metall Prosecco lackiert Métal laqué Prosecco</p>	
<p>OPM18 Metallo verniciato anodico bronzo <i>Anodico bronze painted metal</i> Métal laqué anodico bronze Metall Anodico Bronze lackiert</p>		<p>OPM23 Metallo verniciato tabacco <i>Tobacco painted metal</i> Metall Tabak lackiert Métal laqué tabac</p>	

Finiture rovere _ OAK FINISHES _

OPR1 Rovere tinto ciliegio <i>Cherry stained oak</i> <i>Eiche Kirschbaum gebeizt</i> <i>Chêne teinté merisier</i>		OPR8 Rovere tinto tabacco <i>Tobacco stained oak</i> <i>Eiche tabak gebeizt</i> <i>Chêne teinté tabac</i>	
OPR2 Rovere tinto wengé <i>Wengé stained oak</i> <i>Eiche Wenge gebeizt</i> <i>Chêne teinté wengé</i>		OPR9 Rovere tinto grigio tortora <i>Grey taupe stained oak</i> <i>Eiche beige-grau gebeizt</i> <i>Chêne teinté taupe</i>	
OPR3 Rovere tinto noce <i>Walnut stained oak</i> <i>Eiche Nussbaum gebeizt</i> <i>Chêne teinté noyer</i>		OPR10 Rovere sbiancato <i>Whitened oak</i> <i>Eiche gebleicht</i> <i>Chêne blanchi</i>	
OPR4 Rovere tinto naturale <i>Natural oak</i> <i>Eiche natur farblos lackiert</i> <i>Chêne naturel</i>		OPR11 Rovere tinto antracite <i>Charcoal stained oak</i> <i>Eiche Anthrazit gebeizt</i> <i>Chêne teinté anthracite</i>	
OPR5 Rovere tinto nero <i>Black stained oak</i> <i>Eiche schwarz gebeizt</i> <i>Chêne teinté noir</i>		OPR12 Rovere tinto mogano <i>Mahogany stained oak</i> <i>Eiche mahagonifarbig gebeizt</i> <i>Chêne teinté acajou</i>	
OPR6 Rovere tinto ciliegio Milano <i>Cherry Milano stained oak</i> <i>Eiche Kirschbaum Milano gebeizt</i> <i>Chêne teinté merisier Milano</i>		OPR15 Rovere tinto moka opaco <i>Moka matt stained oak</i> <i>Eiche moka matt gebeizt</i> <i>Chêne teinté moka mat</i>	

Finiture vetro _ GLASS FINISHES _

OPV1 Vetro trasparente <i>Transparent glass</i> <i>Klarglas</i> <i>Verre transparent</i>		OPV7 Vetro retroverniciato nei colori RAL Classic <i>Glass back-painted in the RAL Classic colours</i> <i>Von hinten lackiertes Glas in den RAL Classic Farben</i> <i>Verre laqué de dessous dans les couleurs RAL Classic</i>	Colori RAL standard RAL standard colours
OPV2 Vetro satinato <i>Frosted glass</i> <i>Mattglas</i> <i>Verre dépoli</i>		OPV9 Vetro bronzato retroverniciato cromo <i>Chrome back-painted bronze glass</i> <i>Von hinten chromlackiertes Bronzenglas</i> <i>Verre bronzé laqué de dessous chrome</i>	
OPV3 Vetro retroverniciato RAL 9016 bianco traffico <i>RAL 9016 traffic white back-painted glass</i> <i>RAL 9016 verkehrsweiß von hinten lackiertes Glas</i> <i>Verre laqué de dessous RAL 9016 blanc signalisation</i>		OPV10 Vetro grigio retroverniciato cromo <i>Chrome back-painted grey glass</i> <i>Von hinten chromlackiertes Grauglas</i> <i>Verre gris laqué de dessous chrome</i>	
OPV4 Vetro retroverniciato RAL 9017 nero traffico <i>RAL 9017 traffic black back-painted glass</i> <i>RAL 9017 verkehrsschwarz von hinten lackiertes Glas</i> <i>Verre laqué de dessous RAL 9017 noir signalisation</i>		OPV12 Vetro bronzato trasparente <i>Transparent bronze glass</i> <i>Klarglas bronze</i> <i>Verre transparent bronzé</i>	
OPV5 Vetro retroverniciato RAL 7044 grigio seta <i>RAL 7044 silk grey back-painted glass</i> <i>RAL 7044 seidengrau von hinten lackiertes Glas</i> <i>Verre laqué de dessous RAL 7044 gris soie</i>		OPV13 Vetro grigio trasparente <i>Transparent grey glass</i> <i>Klarglas grau</i> <i>Verre transparent gris</i>	
OPV6 Vetro retroverniciato RAL 1019 beige grigiastro <i>RAL 1019 grey beige back-painted glass</i> <i>RAL 1019 graubeige von hinten lackiertes Glas</i> <i>Verre laqué de dessous RAL 1019 beige gris</i>			

Finiture marmi _ MARBLES FINISHES _

OPP1

Marmo Carrara bianco
Carrara white marble
Marmor Carrara weiss
Marbre blanc Carrara

**OPP12**

Marmo Verde Guatemala
Guatemala green marble
Marmor Guatemala grün
Marbre vert Guatemala

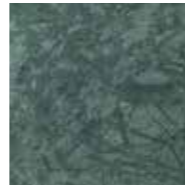
**OPP2**

Marmo nero Marquinia
Marquinia black marble
Marmor Marquinia schwarz
Marbre noir Marquinia

**OPP13**

Marmo Velvet brown
Velvet brown marble
Marmor Velvet brown
Marbre Velvet brown

**OPP3**

Marmo Emperador marrone
Emperador brown marble
Marmor Emperador braun
Marbre brun Emperador

**OPP14**

Marmo Amani Bronze
Amani Bronze marble
Marmor Amani Bronze
Marbre Amani Bronze

**OPP7**

Marmo Calacatta
Calacatta marble
Marmor Calacatta
Marbre Calacatta

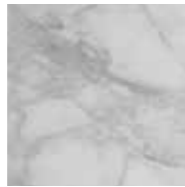
**OPP15**

Marmo Bianco Covelano
Covelano white marble
Marmor Covelano weiss
Marbre blanc Covelano

**OPP9**

Marmo Black and gold
Black and gold marble
Marmor Black and gold
Marbre Black and gold

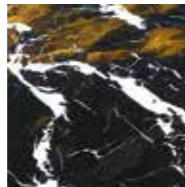
**OPP16**

Marmo Sahara nero
Sahara noir marble
Marmor Sahara noir
Marbre Sahara noir

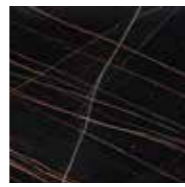
**OPP10**

Marmo Perfetto brown
Perfetto brown marble
Marmor Perfetto braun
Marbre brun Perfetto

**OPP17**

Marmo Port Laurent
Port Laurent marble
Marmor Port Laurent
Marbre Port Laurent

**OPP11**

Marmo Grey Stone
Grey Stone marble
Marmor Grey Stone
Marbre Grey Stone

**OPP18**

Marmo Arabescato Vagli
Arabescato Vagli marble
Marmor Arabescato Vagli
Marbre Arabescato Vagli



Finiture marmi _ MARBLES FINISHES _

OPP19

Marmo Calacatta Vagli
Calacatta Vagli marble
Marmor Calacatta Vagli
Marbre Calacatta Vagli

**OPP21**

Marmo Calacatta viola
Calacatta violet marble
Marmor Calacatta violett
Marbre Calacatta violet

**OPP20**

Marmo Arabescato grigio orobico
Arabescato orobico grey marble
Marmor arabescato orobico grau
Marbre arabescato orobico gris

**OPP22**

Marmo Travertino
Travertino marble
Marmor Travertino
Marbre Travertino



Finiture pietre _ STONES FINISHES _

Finiture gres porcellanato effetto marmo

_ PORCELAIN STONEWARE MARBLE EFFECT FINISHES _

OPP4

Pietra Serena grigia
Grey Serena stone
Grauer Serena Stein
Pierre grise Serena

**OPG2**

Nero Marquinia

**OPP5**

Pietra di Brera beige
Beige Brera stone
Beige Brera Stein
Pierre beige Brera

**OPG6**

Statuario Supremo



Schede tecniche

TECHNICAL INFORMATION

Afra _ 2023 _ DESIGN LUCA ERBA

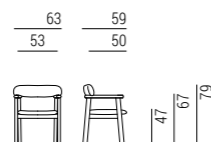

Fusto in legno multistrato di pioppo curvato. Struttura della seduta in legno multistrato con imbottitura in poliuretano espanso a quote differenziate 30 kg/m³ e 40 kg/m³, rivestito in dacron. Rivestimento fisso. La versione standard è dotata di antiscivolanti in PVC. Disponibili a richiesta altri tipi di antiscivolanti, in feltro e plastica.

Carcasse en bois multiplis de peuplier courbé. Structure de l'assise en bois multiplis finie de mousse de polyuréthane de différentes densités de 30 kg/m³ et de 40 kg/m³ couverte de dacron. Revêtement fixe. Equipé de patins en PVC dans la version standard. Disponible sur demande avec d'autres patins, en feutre ou en plastique.

Frame made of curved multi-ply poplar wood. Seat structure made of multi-ply wood, upholstered with polyurethane foam in different densities of 30 Kg/m³ and 40 Kg/m³, covered with dacron. Fixed covers. The standard version is equipped with PVC glides. Other kinds of glides in plastic or felt pads are available on demand.

Каркас из гнутой фанеры тополя. Каркас сиденья из многослойной древесины с набивкой из пенополиуретана дифференцированной плотности 30 кг/м³ и 40 кг/м³, обтянутой дакроном. Фиксированная обивка. Стандартная версия оснащена противоскользящими накладками из ПВХ. Другие типы войлочных и пластиковых противоскользящих накладок доступны по запросу.

Das Gestell besteht aus gebogenem Pappelschichtholz. Sitzstruktur aus Schichtholz, gepolstert mit Polyurethan-Schaumstoff in verschiedenen Dichten 30 Kg/m³ und 40 Kg/m³, mit Dacron ummantelt. Afra ist immer festbezogen. Standard mit PVC-Gleitern ausgestattet. Andere Gleiter, wie Felz- oder Kunststoffgleiter, sind auf Anfrage verfügbar.

Sedie
Chairs



9AFR101
L63 P59 H79

Finiture
Finishes

Base in legno
Wooden base



Code

Cherry stained oak **OPR1** | Wengé stained oak **OPR2** | Walnut stained oak **OPR3** | Natural oak **OPR4** | Black stained oak **OPR5** | Cherry Milano stained oak **OPR6**



Code

Tobacco stained oak **OPR8** | Grey taupe stained oak **OPR9** | Whitened oak **OPR10** | Charcoal stained oak **OPR11** | Mahogany stained oak **OPR12** | Moka matt stained oak **OPR15**

Andy _ 2011 _ DESIGN STUDIO MARELLI

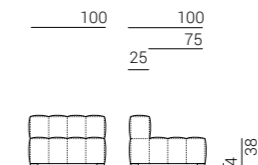

Caratteristica del modello è la tipica lavorazione a "trapuntatura" fatta a mano. Struttura: legno massello e pannelli multistrato rivestiti in poliuretano espanso e dacron. Seduta: imbottitura in poliuretano espanso a quote differenziate di 30 e 40 kg/mc, rivestita con fibre termolegate. Schienale: imbottitura in poliuretano espanso a quote differenziate di 30 e 40 kg/mc, rivestita con fibre termolegate. Rivestimento non sfoderabile.

Die Besonderheit von diesem Modell ist die typische abgesteppte Ausführung, völlig handgetun. Gestell: Massivholz und Multischichtplatten, von Schaumstoff-Polyurethane und Dacron bezogen. Sitzfläche: Polsterung aus unterschiedlich dichtem Schaumstoff-Polyurethane, Dichte 30 und 40 Kg/m³, in thermogebundenen Fasern bezogen. Rückenlehne: Polsterung aus unterschiedlich dichtem Schaumstoff-Polyurethane, Dichte 30 und 40 Kg/m³, in thermogebundenen Fasern bezogen. Bezug: nicht abziehbar.

The peculiarity of this model is the typical "quilting" manufacturing, all handmade. Frame: solid wood and multilayer panels covered in polyurethane foam and dacron. Seat: padding in polyurethane foam, in differentiated densities of 30 and 40 Kg/m³, covered with thermobound fibres. Back: padding in polyurethane foam in differentiated densities of 30 and 40 Kg/m³, covered with thermobound fibres. Cover: not removable.

Главная отличительная особенность данной модели это прошивка по отсекам, сделанная вручную. Каркас: массив дерева в сочетании с многослойной фанерой, пенополиуретан, дакрон. Сиденье: наполнение из пенополиуретана различной плотности, 30 и 40 кг/м³, с покрытием из термосвязанных волокон. Спинка: наполнение из пенополиуретана различной плотности, 30 и 40 кг/м³ с покрытием из термосвязанных волокон. Чехлы: несъемные.

La particularité de ce modèle est la typique finition piquée toute faite à main. Structure: bois massif et panneaux multicouche recouverts de polyuréthane expansé et dacron. Assise: rembourrage de polyuréthane expansé avec densités différenciées, densité 30 et 40 Kg/m³ recouverts de fibres thermoliées. Dossier: rembourrage de poliuréthane expansé avec densités différenciées, densité 30 et 40 Kg/m³ recouverts de fibres thermoliées. Revêtement: pas déhoussable.

Elementi di seduta
Seat elements

Elementi laterali con schienale e bracciolo
Corner elements with backrest and armrest



9AD103
L100 P100 H65

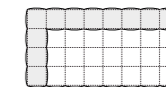
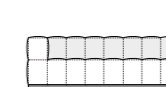

9AD132
L200 P100 H65



9AD124
L125 P100 H65

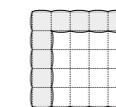

9AD125
L125 P125 H65



9AD126
L150 P100 H65

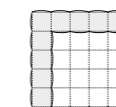

9AD127
L150 P125 H65

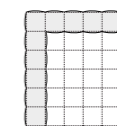

9AD128
L150 P150 H65

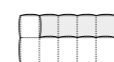

9AD129
L175 P100 H65

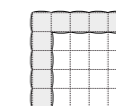

9AD130
L175 P125 H65

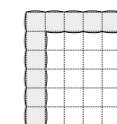

9AD131
L175 P150 H65

Andy _2011_ DESIGN STUDIO MARELLI

Elementi di seduta
Seat elements

Elementi centrali con schienale
Central elements with backrest

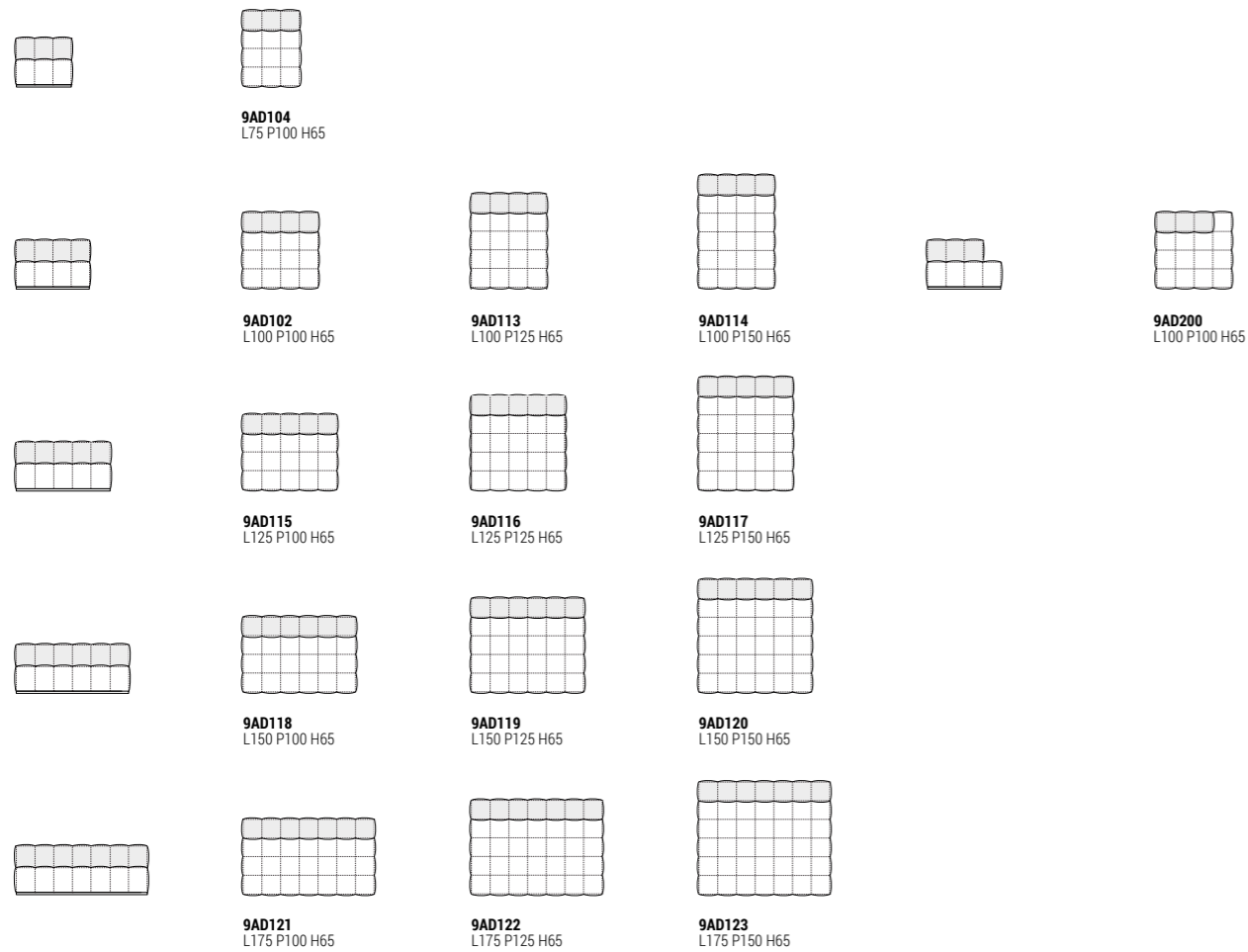

Finiture base
Base finishes



Andy _2011_ DESIGN STUDIO MARELLI

Pouf
Ottomans

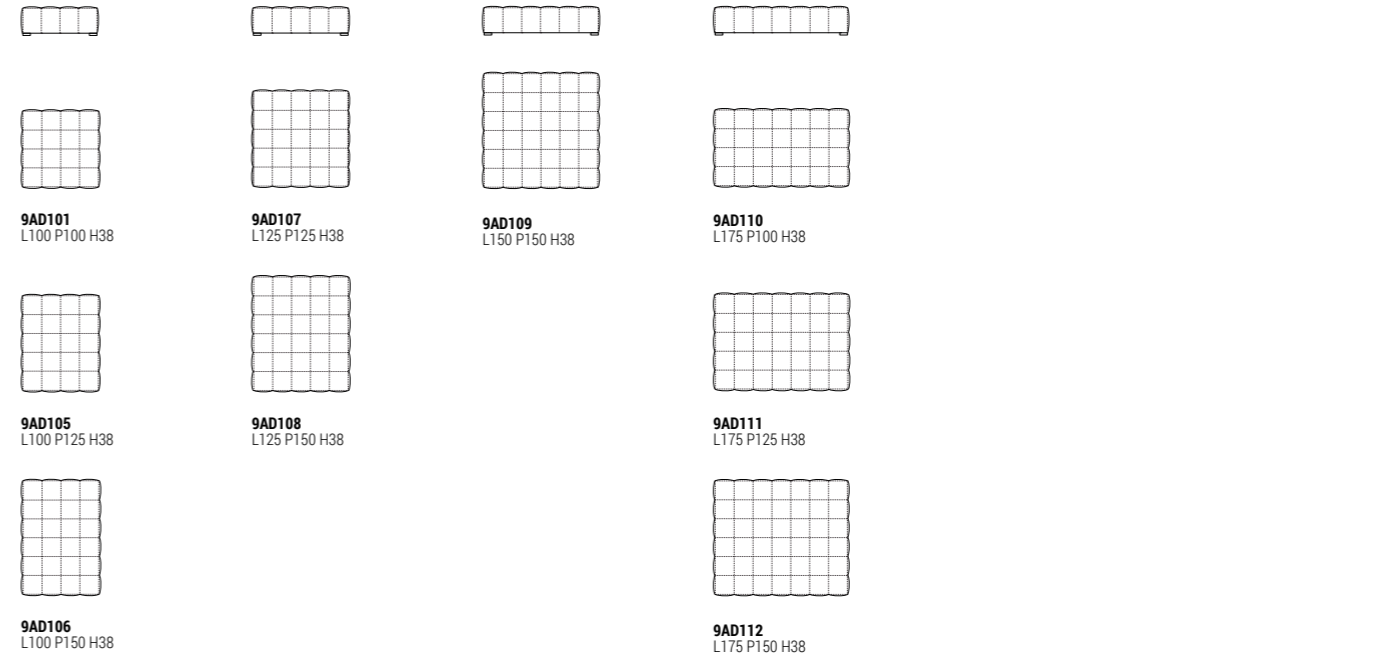

Dormeuse
Longchair

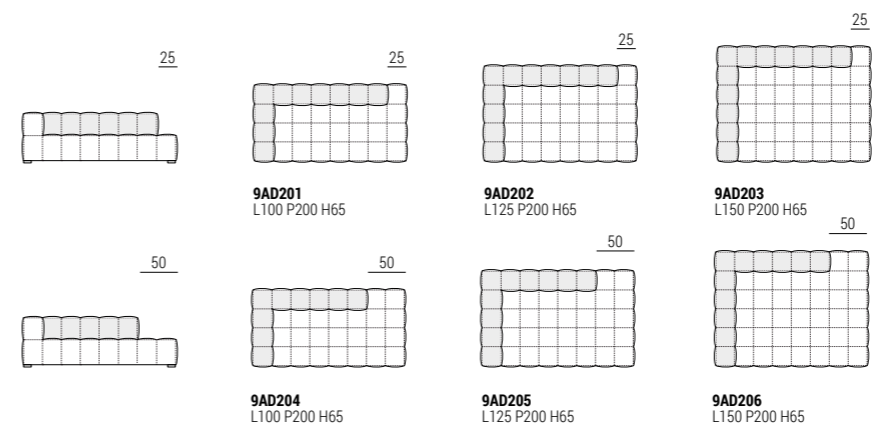

Arnold _2024_ DESIGN STUDIO MARELLI

Comodino
Bedside table



TARN101
L45 P46 H38

Arnold _2024_ DESIGN STUDIO MARELLI

Finiture
Finishes

Struttura in MDF verniciato <i>Painted MDF structure</i>										
Code	Brushed matt chrome metal OPM2	Brushed matt dark grey metal OPM3	RAL 9017 black painted metal OPM6	RAL 9016 white painted metal OPM7	Classic bronze painted metal OPM9	Golden beach painted metal OPM10	Gold pearl painted metal OPM11	Brushed copper metal OPM12		
Code	Brushed antique brass metal OPM13	Brushed antique gold metal OPM15	Anodyc bronze metal OPM18	Delabre pewter brushed metal OPM19	Delabre brass brushed metal OPM20	Dark bronze painted metal OPM21	Prosecco painted metal OPM22	Tobacco painted metal OPM23		
Frontale del cassetto in marmo <i>Marble drawer front</i>										
Code	White Carrara marble OPP1	Black Marquina marble OPP2	Brown Emperador marble OPP3	Grey Serena stone OPP4	Beige Brera stone OPP5	Calacatta marble OPP7	Black and gold marble OPP9	Perfetto brown marble OPP10	Grey Stone marble OPP11	Guatemala green marble OPP12
Code	Velvet brown marble OPP13	Amani Bronze marble OPP14	Covelano white marble OPP15	Sahara noir marble OPP16	Port Laurent marble OPP17	Arabescato orobico grey marble OPP20	Calacatta violet marble OPP21	Travertino marble OPP22		

Arthur _2022_ DESIGN STUDIO MARELLI

Tavoli
Tables

<p>7ART201 Top marmo/Marble top 7ART211 Top vetro/Glass top ø50 H50</p>	<p>7ART202 Top marmo/Marble top 7ART212 Top vetro/Glass top ø60 H40</p>	<p>7ART204 Top marmo/Marble top 7ART214 Top vetro/Glass top ø100 H30</p>	<p>7ART203 Top marmo/Marble top 7ART213 Top vetro/Glass top ø120 H30 ★ No chrome finishes</p>	
<p>7ART205 Top marmo/Marble top 7ART215 Top vetro/Glass top L50 P50 H50</p>	<p>7ART206 Top marmo/Marble top 7ART216 Top vetro/Glass top L60 P60 H40</p>	<p>7ART207 Top marmo/Marble top 7ART217 Top vetro/Glass top L90 P90 H30</p>	<p>7ART208 Top marmo/Marble top 7ART218 Top vetro/Glass top L100 P100 H30 ★ No chrome finishes</p>	<p>7ART209 Top marmo/Marble top 7ART219 Top vetro/Glass top L120 P120 H30 ★ No chrome finishes</p>

Arthur _2022_ DESIGN STUDIO MARELLI

Finiture
Finishes

Top in marmo Marble top											
Code	White Carrara marble OPP1	Black Marquina marble OPP2	Brown Emperador marble OPP3	Grey Serena stone OPP4	Beige Brera stone OPP5	Calacatta marble OPP7	Black and gold marble OPP9	Perfetto brown marble OPP10	Grey Stone marble OPP11	Guatemala green marble OPP12	
Code											
Code	Velvet brown marble OPP13	Amani Bronze marble OPP14	Covelano white marble OPP15	Sahara noir marble OPP16	Port Laurent marble OPP17	Arabescato orobico grey marble OPP20	Calacatta violet marble OPP21				
Top in Gres Porcellanato Porcelain Stoneware Top											
Code	Nero Marquina OPG2	Statuario Supremo OPG6									
Top in vetro Glass top											
Code	RAL 9016 traffic white back-painted glass OPV3	RAL 9017 traffic black back-painted glass OPV4	RAL 7044 silk grey back-painted glass OPV5	RAL 1019 grey beige back-painted glass OPV6	Chrome back-painted bronze glass OPV9	Chrome back-painted grey glass OPV10					
Base in metallo Metal Base											
Code	Shiny chrome metal OPM1	Brushed matt chrome metal OPM2	Brushed matt dark grey metal OPM3	RAL 9017 black painted metal OPM6	RAL 9016 white painted metal OPM7	Classic bronze painted metal OPM9	Golden beach painted metal OPM10	Gold pearl painted metal OPM11	Brushed copper metal OPM12	Brushed antique brass metal OPM13	
Code											
Code	Shiny black chrome metal OPM14	Brushed antique gold metal OPM15	Shiny brass chrome metal OPM16	Bronze metal OPM17	Anodyc bronze metal OPM18	Delabre pewter brushed metal OPM19	Delabre brass brushed metal OPM20	Dark bronze painted metal OPM21	Prosecco painted metal OPM22	Tobacco painted metal OPM23	

Arthur Dining Table _2022_ DESIGN STUDIO MARELLI

Tavolo
Table

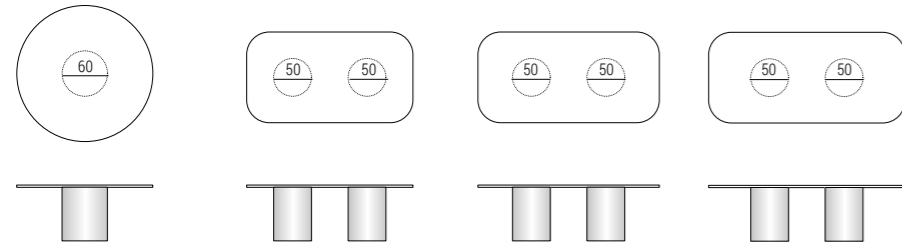

7ART301
Top in marmo/Marble top
7ART311
Top in vetro/Glass top
7ART321
Top in legno/Wooden top
ø180 H74

7ART302
Top in marmo/Marble top
7ART312
Top in vetro/Glass top
7ART322
Top in legno/Wooden top
L220 P120 H74

7ART303
Top in marmo/Marble top
7ART313
Top in vetro/Glass top
7ART323
Top in legno/Wooden top
L240 P120 H74

7ART304
Top in marmo/Marble top
7ART314
Top in vetro/Glass top
7ART324
Top in legno/Wooden top
L260 P120 H74



7ART305
Top in marmo/Marble top
7ART315
Top in vetro/Glass top
7ART325
Top in legno/Wooden top
L320 P120 H74

7ART306
Top in marmo/Marble top
7ART316
Top in vetro/Glass top
7ART326
Top in legno/Wooden top
L310 P140 H74

Top: marmo/rovere massello, spessore 20 mm
Top: marble/solid oak, 20 mm thick

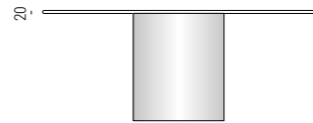

Top: vetro, spessore 10 mm
Top: glass, 10 mm thick



Arthur Dining Table _2022_ DESIGN STUDIO MARELLI

Finiture
Finishes

Top in marmo
Marble top

White Carrara marble OPP1	Black Marquina marble OPP2	Brown Emperador marble OPP3	Grey Serena stone OPP4	Beige Brera stone OPP5	Calacatta marble OPP7	Black and gold marble OPP9	Perfetto brown marble OPP10	Grey Stone marble OPP11	Guatemala green marble OPP12
Velvet brown marble OPP13	Amani Bronze marble OPP14	Covelano white marble OPP15	Sahara noir marble OPP16	Port Laurent marble OPP17	Arabescato orobico grey marble OPP20	Calacatta violet marble OPP21	Travertino marble OPP22		

Top in Gres Porcellanato
Porcelain Stoneware Top

Nero Marquina OPG2	Statuario Supremo OPG6

Top in legno
Wooden top

Cherry stained oak OPR1	Wengé stained oak OPR2	Walnut stained oak OPR3	Natural oak OPR4	Black stained oak OPR5	Cherry Milano stained oak OPR6
Tobacco stained oak OPR8	Grey taupe stained oak OPR9	Whitened oak OPR10	Charcoal stained oak OPR11	Mahogany stained oak OPR12	Moka matt stained oak OPR15

Top in vetro
Glass top

RAL 9016 traffic white back-painted glass OPV3	RAL 9017 traffic black back-painted glass OPV4	RAL 7044 silk grey back-painted glass OPV5	RAL 1019 grey beige back-painted glass OPV6	Chrome back-painted bronze glass OPV9	Chrome back-painted grey glass OPV10

Base in metallo
Metal Base

Brushed matt chrome metal OPM2	Brushed matt dark grey metal OPM3	RAL 9017 black painted metal OPM6	RAL 9016 white painted metal OPM7	Classic bronze painted metal OPM9	Golden beach painted metal OPM10	Gold pearl painted metal OPM11	Brushed copper metal OPM12
Brushed antique brass metal OPM13	Brushed antique gold metal OPM15	Anodyc bronze metal OPM18	Delabre pewter brushed metal OPM19	Delabre brass brushed metal OPM20	Dark bronze painted metal OPM21	Prosecco painted metal OPM22	Tobacco painted metal OPM23

Atacama _2020_ DESIGN MARCO CATTANEO

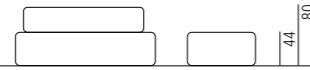

Fusto in legno massello e multistrato rivestito in poliuretano espanso a quote differenziate 30 kg/m³ e 40 kg/m³ e dacron.
Rivestimento fisso non sfoderabile.

Carcasse en bois massif et multiplis finie de mousse polyuréthane de différentes densités de 30 kg/m³ et 40 kg/m³, couverte de dacron.
Le revêtement est toujours fixe.

Frame made of solid wood and multi-ply wood, upholstered with polyurethane foam in different densities of 30 kg/m³ and 40 kg/m³ and covered with dacron.
Fixed covers.

Каркас из массива дерева и фанеры покрыт пенополиуретаном различной плотности 30 кг / м³ и 40 кг / м³ и дакрон.
Неподвижная крышка не снимается.

Das Gestell besteht aus Massiv- und Schichtholz, gepolstert mit Polyurethanschaumstoff in verschiedenen Dichten 30 Kg/m³ und 40 Kg/m³, mit Dacron ummantelt.
Atacama ist immer festbezogen.

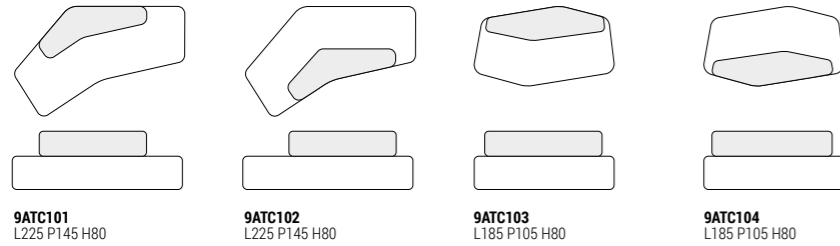
Divani
Sofas

9ATC101
L225 P145 H80

9ATC102
L225 P145 H80

9ATC103
L185 P105 H80

9ATC104
L185 P105 H80

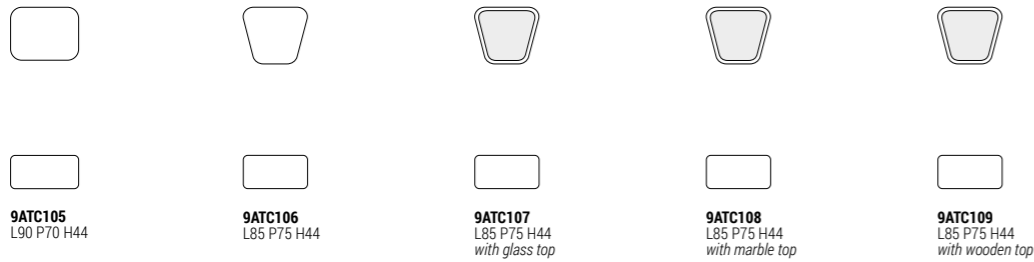
Pouf e accessori
Ottomans and accessoires

9ATC105
L90 P70 H44

9ATC106
L85 P75 H44

9ATC107
L85 P75 H44
with glass top

9ATC108
L85 P75 H44
with marble top

9ATC109
L85 P75 H44
with wooden top

Atacama _2020_ DESIGN MARCO CATTANEO

Finiture
FinishesTop in etro
Glass top

Code

RAL 9016
traffic white
back-painted glass
OPV3

RAL 9017
traffic black
back-painted glass
OPV4

RAL 7044
silk grey
back-painted glass
OPV5

RAL 1019
grey beige
back-painted glass
OPV6

Chrome
back-painted
bronze glass
OPV9

Chrome
back-painted
grey glass
OPV10

Top in marmo
Marble top

Code

White Carrara
marble
OPP1

Black Marquina
marble
OPP2

Brown
Emperador
marble
OPP3

Perfetto brown
marble
OPP10

Guatemala
green
marble
OPP12

Velvet brown
marble
OPP13

Top in legno
Wooden top

Code

Cherry
stained oak
OPR1

Wengé
stained oak
OPR2

Walnut
stained oak
OPR3

Natural
oak
OPR4

Black
stained oak
OPR5

Cherry Milano
stained oak
OPR6

Code

Tobacco
stained oak
OPR8

Grey taupe
stained oak
OPR9

Whitened
oak
OPR10

Charcoal
stained oak
OPR11

Mahogany
stained oak
OPR12

Moka matt
stained oak
OPR15

Optional
Optionals

9ATC200
ø50 P68
Bachmann Pix socket



Atene _ 2021 _ DESIGN LUCA ERBA

Tavoli
Tables

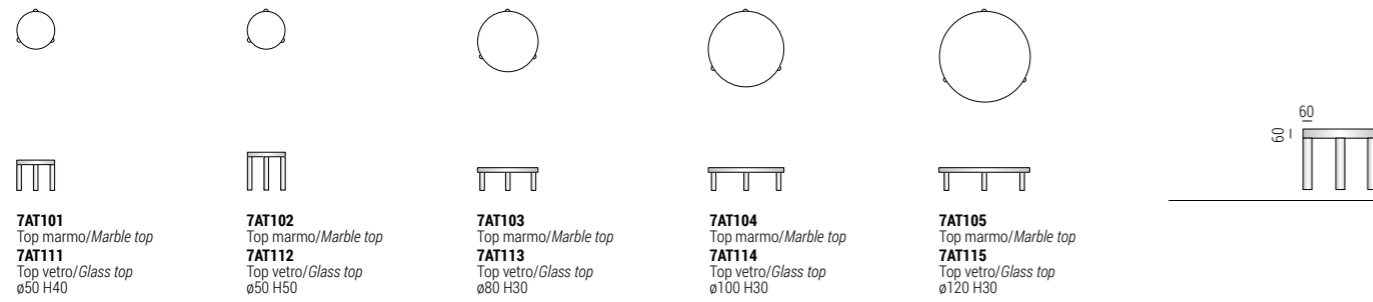

- 7AT101**
Top marmo/Marble top
7AT111
Top vetro/Glass top
ø50 H40
- 7AT102**
Top marmo/Marble top
7AT112
Top vetro/Glass top
ø50 H50
- 7AT103**
Top marmo/Marble top
7AT113
Top vetro/Glass top
ø80 H30
- 7AT104**
Top marmo/Marble top
7AT114
Top vetro/Glass top
ø100 H30
- 7AT105**
Top marmo/Marble top
7AT115
Top vetro/Glass top
ø120 H30

Atene _ 2021 _ DESIGN LUCA ERBA

Finiture
Finishes

Top in marmo Marble top										
Code	White Carrara marble OPP1	Black Marquina marble OPP2	Brown Emperador marble OPP3	Grey Serena stone OPP4	Beige Brera stone OPP5	Calacatta marble OPP7	Black and gold marble OPP9	Perfetto brown marble OPP10	Grey Stone marble OPP11	Guatemala green marble OPP12
Code	Velvet brown marble OPP13	Amani Bronze marble OPP14	Covelano white marble OPP15	Sahara noir marble OPP16	Port Laurent marble OPP17	Calacatta Vagli marble OPP19	Arabescato orobico grey marble OPP20	Calacatta violet marble OPP21	Travertino marble OPP22	
Top in vetro Glass top										
Code	RAL 9016 traffic white back-painted glass OPV3	RAL 9017 traffic black back-painted glass OPV4	RAL 7044 silk grey back-painted glass OPV5	RAL 1019 grey beige back-painted glass OPV6	Chrome back-painted bronze glass OPV9	Chrome back-painted grey glass OPV10				
Base in metallo Metal Base										
Code	Shiny chrome metal OPM1	Brushed matt chrome metal OPM2	Brushed matt dark grey metal OPM3	RAL 9017 black painted metal OPM6	RAL 9016 white painted metal OPM7	Classic bronze painted metal OPM9	Golden beach painted metal OPM10	Gold pearl painted metal OPM11	Brushed copper metal OPM12	Brushed antique brass metal OPM13
Code	Shiny black chrome metal OPM14	Brushed antique gold metal OPM15	Shiny brass chrome metal OPM16	Bronze metal OPM17	Anodyc bronze metal OPM18	Delabre pewter brushed metal OPM19	Delabre brass brushed metal OPM20	Dark bronze painted metal OPM21	Prosecco painted metal OPM22	Tobacco painted metal OPM23
Top in Gres Porcellanato Porcelain Stoneware Top										
Code	Nero Marquina OPG2	Statuario Supremo OPG6								

Bea _2022_ DESIGN STUDIO MARELLI

Schienale in legno multistrato di pioppo curvato imbottito con poliuretano espanso con densità 30 kg/ m³. Seduta in legno multistrato di pioppo imbottito con poliuretano espanso 40 kg/m³, rivestito in dacron con cinghie elastiche intrecciate. Rivestimento fisso. Basamento in rovere nelle finiture standard o rivestito in tessuto o pelle. La versione standard è dotata di antiscivolanti in PVC. Disponibili a richiesta altri tipi di antiscivolanti, in feltro e plastica.

Dossier en bois multiplis de peuplier courbé fini de mousse de polyuréthane de densité de 30 kg/m³. Structure de l'assise en bois multiplis de peuplier fini de mousse de polyuréthane de densité de 40 kg/m³ couverte de dacron, muni de bandes élastiques entrecroisées. Revêtement fixe. Piètement en chêne dans les finitions standard ou recouvert de tissu ou cuir. Equipé de patins en PVC dans la version standard. Disponible sur demande avec d'autres patins, en feutre ou en plastique.

Backrest made of curved multi-ply poplar wood, upholstered with polyurethane foam with density 30 kg/ m³. Seat structure made of multi-ply poplar wood, upholstered with polyurethane foam with density of 40 Kg/m³, covered with dacron, with interwoven elastic belts. Fixed covers. Oak base in the standard finishes or covered with fabric or leather. The standard version is equipped with PVC glides. Other kinds of glides in plastic or felt pads are available on demand.

Для изготовления спинки используется гнутая многослойная фанера из тополя с наполнением из вспененного полиуретана плотностью 30 кг/м³. Конструкция сиденья: многослойная фанера из тополя с наполнением из вспененного полиуретана плотностью 40 кг/м³, обернутого в дакрон, в сочетании с перекрещивающимися эластичными ремнями. Обивка несъемная.

Rückenlehne aus aus gebogenem Pappelschichtholz, gepolstert mit Polyurethan-Schaumstoff mit Dichte 30 Kg/m³. Sitzstruktur aus Pappelschichtholz, gepolstert mit Polyurethan-Schaumstoff mit Dichte 40 Kg/m³, mit Dacron ummantelt, mit geflochtenen Gummigurten. Paris ist immer festbezogen. Eichengestell in den Standard-Ausführungen oder mit Stoff oder Leder bezogen. Standard mit PVC-Gleitern ausgestattet. Andere Gleiter, wie Felz- oder Kunststoffgleiter, sind auf Anfrage verfügbar.

Основание стула выполнено из дуба в стандартных цветах, либо в коже или ткани. В стандартный комплект по умолчанию входят противоскользящие накладки из ПВХ. По запросу возможно их изготовление из войлока или пластика.

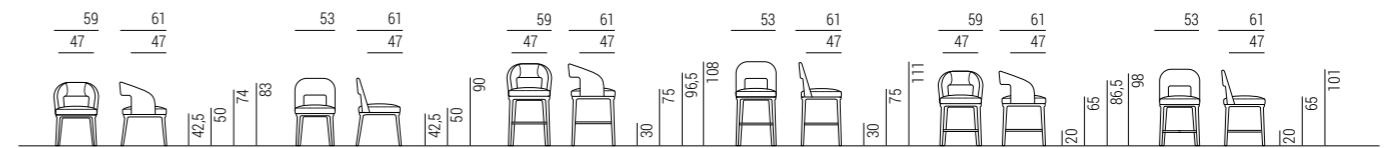
Sedie
Chairs

9BEA101
L53 P61 H90



9BEA102
L59 P61 H83



9BEA301
L53 P61 H111



9BEA302
L53 P61 H101



9BEA303
L59 P61 H108



9BEA304
L59 P61 H98

Finiture
Finishes

Base standard
Standard base



Code

Cherry stained oak **OPR1** Wengé stained oak **OPR2** Walnut stained oak **OPR3** Natural oak **OPR4** Black stained oak **OPR5** Cherry Milano stained oak **OPR6**



Code

Tobacco stained oak **OPR8** Grey taupe stained oak **OPR9** Whitened oak **OPR10** Charcoal stained oak **OPR11** Mahogany stained oak **OPR12** Moka matt stained oak **OPR15**

Base optional
Optional base

Base in rovere rivestita in tessuto / pelle
Oak base covered in fabric / leather

Break _ 2009 _ DESIGN STUDIO MARELLI

Tavoli
Tables

40 28	60 28	80 35	90 35	
7BR101 Top marmo/Marble top 7BR104 Top MDF/MDF top 7BR111 Top legno/Wooden top 7BR117 Top vetro/Glass top 7BR114 Top metallo/Metal top ø40 H45	7BR102 Top marmo/Marble top 7BR105 Top MDF/MDF top 7BR112 Top legno/Wooden top 7BR118 Top vetro/Glass top 7BR115 Top metallo/Metal top ø60 H36	7BR103 Top marmo/Marble top 7BR106 Top MDF/MDF top 7BR113 Top legno/Wooden top 7BR119 Top vetro/Glass top 7BR116 Top metallo/Metal top ø80 H27	7BR120 Top marmo/Marble top L90 P60 H28	Top: marmo/rovere massello/MDF, spessore 20 mm Base: metallo, spessore 10 mm Top: marble/solid oak/MDF, 20 mm thick Base: metal, 10 mm thick

Break _ 2009 _ DESIGN STUDIO MARELLI

Finiture
Finishes

Top in marmo Marble top										
Code	White Carrara marble OPP1	Black Marquina marble OPP2	Brown Emperador marble OPP3	Grey Serena stone OPP4	Beige Brera stone OPP5	Calacatta marble OPP7	Black and gold marble OPP9	Perfetto brown marble OPP10	Grey Stone marble OPP11	Guatemala green marble OPP12
Code										
Code	Velvet brown marble OPP13	Amani Bronze marble OPP14	Covelano white marble OPP15	Sahara noir marble OPP16	Port Laurent marble OPP17	Arabescato orobico grey marble OPP20	Calacatta violet marble OPP21	Travertino marble OPP22		
Top in Gres Porcellanato Porcelain Stoneware Top										
Code	Nero Marquina OPG2	Statuario Supremo OPG6								
Top in rovere massello Solid oak top										
Code	Cherry stained oak OPR1	Wengé stained oak OPR2	Walnut stained oak OPR3	Natural oak OPR4	Black stained oak OPR5	Cherry Milano stained oak OPR6				
Code										
Code	Tobacco stained oak OPR8	Grey taupe stained oak OPR9	Whitened oak OPR10	Charcoal stained oak OPR11	Mahogany stained oak OPR12	Moka matt stained oak OPR15				
Base/top in metallo Metal base/top										
Code	Shiny chrome metal OPM1	Brushed matt chrome metal OPM2	Brushed matt dark grey metal OPM3	RAL 9017 black painted metal OPM6	RAL 9016 white painted metal OPM7	Classic bronze painted metal OPM9	Golden beach painted metal OPM10	Gold pearl painted metal OPM11	Brushed copper metal OPM12	Brushed antique brass metal OPM13
Code										
Code	Shiny black chrome metal OPM14	Brushed antique gold metal OPM15	Shiny brass chrome metal OPM16	Bronze metal OPM17	Anodyc bronze metal OPM18	Delabre pewter brushed metal OPM19	Delabre brass brushed metal OPM20	Dark bronze painted metal OPM21	Prosecco painted metal OPM22	Tobacco painted metal OPM23

Brera _ 2021 _ DESIGN PAOLO SALVADÈ

Struttura in tubolare di metallo ricoperto con schiuma di poliuretano a freddo ignifugo, classe 1IM, rivestito con una fodera in fibra acrilica. Cuscino di seduta in poliuretano espanso con densità 40 kg/m³ (5,9 KPA), rivestito in fibra acrilica.
Il rivestimento è sempre fisso.

Structure en métal tubulaire recouvert de mousse à froid ignifuge classe 1IM, recouverte d'une housse en fibre acrylique. Coussin d'assise en mousse de polyuréthane avec une densité de 40 kg/m³ (5,9 kPa), recouverte de fibre acrylique.

Le revêtement est toujours fixe.

Metal tube structure upholstered with cold injected fire retardant polyurethane foam class 1IM, covered with acrylic fibre. Seat cushion in polyurethane foam with density 40 kg/m³ (5,9 KPA), lined with acrylic fibre.
Fixed covers.

Каркас выполнен из профильной металлической трубы, покрытой слоем огнестойкого пенополиуретана холодного формования, класс 1 IM, и помещенной в чехол из акрилового волокна. Наполнение подушки сиденья выполнено из вспененного полиуретана плотностью 40 кг/м³ (5,9 кПа), помещенного в чехол из акрилового волокна. Обивка только несъемная.

Struktur der Sitzschale in Metall überschäumt mit Polyurethan-Kaltschaumstoff, Feuerwiderstandsklasse 1IM, mit Acrylfaser ummantelt. Sitzkissen aus Polyurethan-Schaumstoff mit Dichte 40 Kg/m³ (5,9 KPA), mit Acrylfaser ummantelt.
Bezüge immer fix, nicht abziehbar.

Brera _ 2021 _ DESIGN PAOLO SALVADÈ

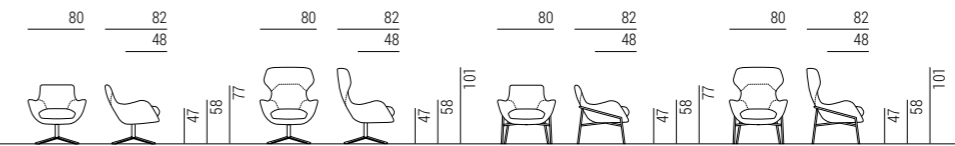

Poltrone Armchairs



9BRE101
L80 P82 H77
Swivel metal base



9BRE102
L80 P82 H77
Wood base



9BRE103
L80 P82 H77
Metal base



9BRE104
L80 P82 H101
Swivel metal base



9BRE105
L80 P82 H101
Wood base



9BRE106
L80 P82 H101
Metal base

Finiture Finishes

Base in metallo Metal base

Code	OPM1	OPM2	OPM3	OPM6	OPM7	OPM9	OPM10	OPM11	OPM12	OPM13
Code	OPM14	OPM15	OPM16	OPM17	OPM18	OPM19	OPM20	OPM21	OPM22	OPM23

Base in legno Wooden base

Code	OPR1	OPR2	OPR3	OPR4	OPR5	OPR6
Code	OPR8	OPR9	OPR10	OPR11	OPR12	OPR15

Base girevole in metallo Swivel metal base

Code	OPM6	OPM9	OPM10	OPM11	OPM15	OPM18	OPM21	OPM22	OPM23

Chia _2016_ DESIGN STEFANO GALLIZZOLI

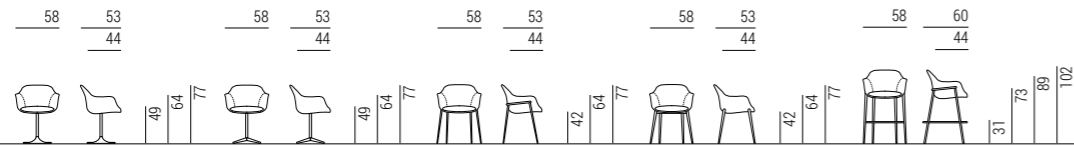

Struttura in tubolare di metallo ricoperto con schiuma di poliuretano a freddo ignifugo, classe 1IM. Cuscino di seduta con struttura in Baydur® 80IK28/DO con imbottitura in poliuretano espanso con densità 40 kg/m³ (5,9 KPA), rivestito in fibra acrilica. Il rivestimento è sempre fisso. Il basamento girevole è in metallo a 4 razze. Basamento girevole in metallo disponibile in due versioni.

Structure en métal tubulaire recouvert de mousse à froid ignifuge classe 1IM. Coussin d'assise avec structure en Baydur® 80IK28/DO, rembourré en mousse polyuréthane d'une densité de 40 kg/m³ (5,9 KPA), recouverte de fibre acrylique. Le revêtement est toujours fixe. Base pivotante en métal à 4 pieds. Base pivotante en métal disponible en deux versions.

Metal tube structure upholstered with cold injected fire retardant polyurethane foam class 1IM. Seat cushion with structure in Baydur® 80IK28/DO upholstered with polyurethane foam with density of 40 kg/m³ (5,9 KPA), covered with acrylic fibre. Covers are always fixed. The metal swivel base is a 4-star base. Metal swivel base available in two versions.

Каркас из металлического профиля, покрытого слоем огнеупорного пенополиуретана холодного отверждения класса 1IM. Подушка сиденья имеет основу из Baydur® 80IK28/DO и наполнение из вспененного полиуретана плотностью 40 кг/м³ (5,9 Кпа), обернутого в акриловое волокно. Обивка подушки несъемная. Вращающееся металлическое основание имеет 4 опоры.

Struktur der Sitzschale in Metall überschäumt mit Polyurethan-Kaltschaumstoff, Feuerwiderstandsklasse 1IM. Sitzkissen mit Gestell in Baydur® 80IK28/DO, gepolstert mit Polyurethanschaumstoff mit Dichte 40 Kg/m³ (5,9 KPA), mit Acrylfaser ummantelt. Bezüge immer fix, nicht abziehbar. Das Drehgestell ist in Metall, mit 4-Fusskreuz mit Standsäule. Das Drehgestell ist in zwei Versionen erhältlich.

Baydur® - полимерный материал, производимый концерном Bayer. Металлическая поворотная основа доступна в двух версиях.

Poltrone
Armchairs

9CHI104
L58 P53 H77
Poltroncina con base in metallo
Armchair with metal base



9CHI105
L58 P53 H77
Poltroncina con base in legno
Armchair with wooden base



9CHI106
L58 P60 H102
Sgabellò con base in metallo
Barstools with metal base



9CHI103
L58 P53 H77
Poltroncina girevole
con base in metallo
Swivel armchair with metal base



9CHI107
L58 P53 H77
Poltroncina girevole
con base in metallo
Swivel armchair with metal base



9CHI108
L58 P60 H93/112
Sgabellò girevole
con base in metallo
Swivel barstools with metal base

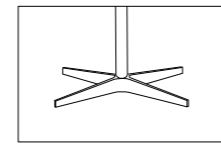

9CHI109
L58 P60 H93/112
Sgabellò girevole
con base in metallo
Swivel barstools with metal base

Basi girevoli
Swivel bases

Base girevole in metallo
per **9CHI103**
Swivel metal base for **9CHI103**

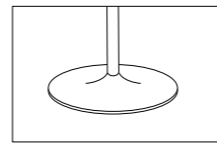

Base girevole in metallo
per **9CHI107**
Swivel metal base for **9CHI107**

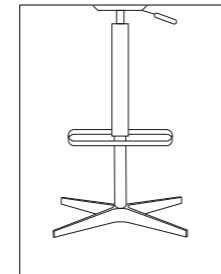

Base girevole in metallo
per **9CHI108**
Swivel metal base for **9CHI108**

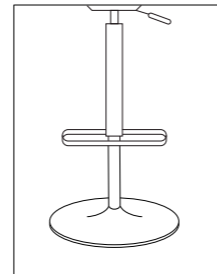

Base girevole in metallo
per **9CHI109**
Swivel metal base for **9CHI109**

Chia _2016_ DESIGN STEFANO GALLIZZOLI

Finiture
Finishes**9CHI103**
Base in metallo
Metal base

Code



Shiny
chrome metal
OPM1



Brushed matt
chrome metal
OPM2



Brushed matt
dark grey metal
OPM3



RAL 9017 black
painted metal
OPM6

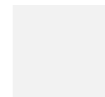

RAL 9016 white
painted metal
OPM7



Classic bronze
painted metal
OPM9



Golden beach
painted metal
OPM10



Gold pearl
painted metal
OPM11

Code



Brushed
copper metal
OPM12



Brushed
antique
brass metal
OPM13



Brushed
antique
gold metal
OPM15



Anodyc
bronze metal
OPM18

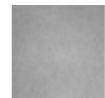

Delabre pewter
brushed metal
OPM19



Delabre brass
brushed metal
OPM20



Dark bronze
painted metal
OPM21



Prosecco
painted metal
OPM22



Tobacco
painted metal
OPM23

9CHI104**9CHI106****9CHI107****9CHI108****9CHI109**Base in metallo
Metal base

Code



Brushed matt
chrome metal
OPM2



Brushed matt
dark grey metal
OPM3



RAL 9017 black
painted metal
OPM6

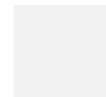

RAL 9016 white
painted metal
OPM7



Classic bronze
painted metal
OPM9



Golden beach
painted metal
OPM10



Gold pearl
painted metal
OPM11



Brushed
copper metal
OPM12



Brushed
antique
brass metal
OPM13



Brushed
antique
gold metal
OPM15

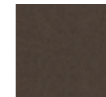

Anodyc
bronze metal
OPM18

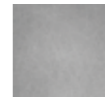

Delabre pewter
brushed metal
OPM19



Delabre brass
brushed metal
OPM20

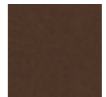

Dark bronze
painted metal
OPM21



Prosecco
painted metal
OPM22



Tobacco
painted metal
OPM23

9CHI105Base in legno
Wooden base

Code



Cherry
stained oak
OPR1



Wengé
stained oak
OPR2



Walnut
stained oak
OPR3



Natural
oak
OPR4



Black
stained oak
OPR5



Cherry Milano
stained oak
OPR6



Tobacco
stained oak
OPR8



Grey taupe
stained oak
OPR9



Whitened
oak
OPR10



Charcoal
stained oak
OPR11



Mahogany
stained oak
OPR12



Moka matt
stained oak
OPR15

Code

Clara _2025_ DESIGN LUCA ERBA

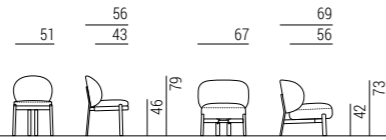

Poltrone
Armchairs



9CLA101
L51 P56 H79



9CLA103
L67 P69 H73

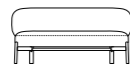

9CLA105
L160 P69 H73



9CLA102
L51 P56 H79



9CLA104
L67 P69 H73

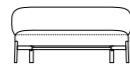

9CLA106
L160 P69 H73

Clara _2025_ DESIGN LUCA ERBA

Finiture
Finishes

9CLA101
9CLA103
9CLA105
Base in metallo
Metal base



Code	RAL 9017 black painted metal OPM6	Classic bronze painted metal OPM9	Golden beach painted metal OPM10	Gold pearl painted metal OPM11	Anodyc bronze metal OPM18	Dark bronze painted metal OPM21	Prosecco painted metal OPM22	Tobacco painted metal OPM23
-------------	---	---	--	--	-------------------------------------	---	--	---------------------------------------

















9CLA102
9CLA104
9CLA106
Base in metallo
Metal base



Code	Brushed matt chrome metal OPM2	Brushed matt dark grey metal OPM3	Brushed copper metal OPM12	Brushed antique brass metal OPM13	Brushed antique gold metal OPM15	Delabre pewter brushed metal OPM19	Delabre brass brushed metal OPM20
-------------	--	---	--------------------------------------	---	--	--	---

Dune _ 2020 _ DESIGN PAOLO SALVADÈ

Tavoli
Tables

 	 	 	 
7DU101 Ø40 H42 con top marmo with marble top 7DU111 Ø40 H42 con top vetro with glass top	7DU102 Ø40 H52 con top marmo with marble top 7DU112 Ø40 H52 con top vetro with glass top	7DU103 L130 P80 H37 con top marmo with marble top 7DU113 L130 P80 H37 con top vetro with glass top	7DU104 L120 P80 H37 con top marmo with marble top 7DU114 L120 P80 H37 con top vetro with glass top
 	 	 	 
7DU105 L90 P90 H37 con top marmo with marble top 7DU115 L90 P90 H37 con top vetro with glass top	7DU106 Ø125 H37 con top marmo with marble top 7DU116 Ø125 H37 con top vetro with glass top	7DU107 L100 P100 H37 con top marmo with marble top 7DU117 L100 P100 H37 con top vetro with glass top	7DU108 Ø80 H37 con top marmo with marble top 7DU118 Ø80 H37 con top vetro with glass top

Top: marmo, spessore 20 mm
Top: marble, 20 mm thick

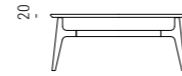

Top: Gres Porcellanato, spessore 12 mm
Top: Porcelain Stoneware, 20 mm thick

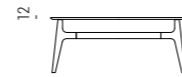

Top: metallo/vetro, spessore 10 mm
Top: metal/glass, 10 mm thick

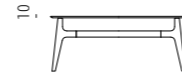

Dune _ 2020 _ DESIGN PAOLO SALVADÈ

Finiture
Finishes

Base in legno
Wooden base



Code
Cherry stained oak **OPR1** Wengé stained oak **OPR2** Walnut stained oak **OPR3** Natural oak **OPR4** Black stained oak **OPR5** Cherry Milano stained oak **OPR6**



Code
Tobacco stained oak **OPR8** Grey taupe stained oak **OPR9** Whitened oak **OPR10** Charcoal stained oak **OPR11** Mahogany stained oak **OPR12** Moka matt stained oak **OPR15**

Top in marmo
Marble top



Code
White Carrara marble **OPP1** Black Marquina marble **OPP2** Brown Emperador marble **OPP3** Grey Serena stone **OPP4** Beige Brera stone **OPP5** Calacatta marble **OPP7** Black and gold marble **OPP9** Perfetto brown marble **OPP10** Grey Stone marble **OPP11** Guatemala green marble **OPP12**

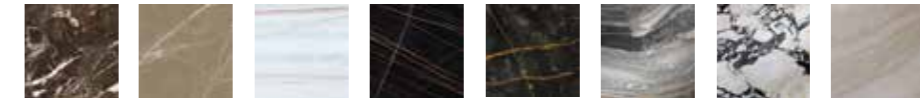

Code
Velvet brown marble **OPP13** Amani Bronze marble **OPP14** Covelano white marble **OPP15** Sahara noir marble **OPP16** Port Laurent marble **OPP17** Arabescato orobico grey marble **OPP20** Calacatta violet marble **OPP21** Travertino marble **OPP22**

Top in Gres Porcellanato
Porcelain Stoneware Top



Code
Nero Marquina **OPG2** Statuario Supremo **OPG6**

Top in vetro
Glass top



Code
Transparent glass **OPV1** Frosted glass **OPV2** RAL 9016 traffic white back-painted glass **OPV3** RAL 9017 traffic black back-painted glass **OPV4** RAL 7044 silk grey back-painted glass **OPV5** RAL 1019 grey beige back-painted glass **OPV6** Chrome back-painted bronze glass **OPV9** Chrome back-painted grey glass **OPV10** Transparent bronze glass **OPV12** Transparent grey glass **OPV13**

Struttura in metallo
eccetto per 7DU101/7DU102
Metal structure
except for 7DU101/7DU102



Code
Shiny chrome metal **OPM1** Brushed matt chrome metal **OPM2** Brushed matt dark grey metal **OPM3** RAL 9017 black painted metal **OPM6** RAL 9016 white painted metal **OPM7** Classic bronze brushed metal **OPM9** Golden beach painted metal **OPM10** Gold pearl painted metal **OPM11** Brushed copper metal **OPM12** Brushed antique brass metal **OPM13**



Code
Shiny black chrome metal **OPM14** Brushed antique gold metal **OPM15** Shiny brass chrome metal **OPM16** Bronze metal **OPM17** Anodyc bronze metal **OPM18** Delabre pewter brushed metal **OPM19** Delabre brass brushed metal **OPM20** Dark bronze painted metal **OPM21** Prosecco painted metal **OPM22** Tobacco painted metal **OPM23**

George _ 2023 _ DESIGN MARCO CATTANEO

Madia
Sideboard

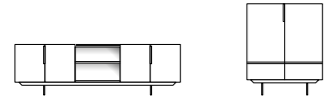

7GE201
Top superiore in marmo
Marble upper top
7GE211
Top superiore in vetro
Glass upper top
L220 P50 H66

7GE202
Top superiore in marmo
Marble upper top
7GE212
Top superiore in vetro
Glass upper top
L100 P50 H120

George _ 2023 _ DESIGN MARCO CATTANEO

Finiture
Finishes

Top in marmo Marble top										
Code	White Carrara marble OPP1	Black Marquina marble OPP2	Brown Emperador marble OPP3	Grey Serena stone OPP4	Beige Brera stone OPP5	Calacatta marble OPP7	Black and gold marble OPP9	Perfetto brown marble OPP10	Grey Stone marble OPP11	Guatemala green marble OPP12
Code	Velvet brown marble OPP13	Amani Bronze marble OPP14	Covelano white marble OPP15	Sahara noir marble OPP16	Port Laurent marble OPP17	Arabescato orobico grey marble OPP20	Calacatta violet marble OPP21	Travertino marble OPP22		
Top in Gres Porcellanato Porcelain Stoneware Top										
Code	Nero Marquina OPG2	Statuario Supremo OPG6								
Top in vetro Glass top										
Code	Transparent glass OPV1	Frosted glass OPV2	RAL 9016 traffic white back-painted glass OPV3	RAL 9017 traffic black back-painted glass OPV4	RAL 7044 silk grey back-painted glass OPV5	RAL 1019 grey beige back-painted glass OPV6	Chrome back-painted bronze glass OPV9	Chrome back-painted grey glass OPV10	Transparent bronze glass OPV12	Transparent grey glass OPV13
Struttura madia/credenza Sideboard/cupboard structure										
Code	Cherry stained oak OPR1	Wengé stained oak OPR2	Walnut stained oak OPR3	Natural oak OPR4	Black stained oak OPR5	Cherry Milano stained oak OPR6				
Code	Tobacco stained oak OPR8	Grey taupe stained oak OPR9	Whitened oak OPR10	Charcoal stained oak OPR11	Mahogany stained oak OPR12	Moka matt stained oak OPR15				
Base e maniglie in metallo Metal base and handles										
Code	Shiny chrome metal OPM1	Brushed matt chrome metal OPM2	Brushed matt dark grey metal OPM3	RAL 9017 black painted metal OPM6	RAL 9016 white painted metal OPM7	Classic bronze painted metal OPM9	Golden beach painted metal OPM10	Gold pearl painted metal OPM11	Brushed copper metal OPM12	Brushed antique brass metal OPM13
Code	Shiny black chrome metal OPM14	Brushed antique gold metal OPM15	Shiny brass chrome metal OPM16	Bronze metal OPM17	Anodyc bronze metal OPM18	Delabre pewter brushed metal OPM19	Delabre brass brushed metal OPM20	Dark bronze painted metal OPM21	Prosecco painted metal OPM22	Tobacco painted metal OPM23

Hebo _2016_ DESIGN GABRIELE CAPPELLETTI

Tavolo in marmo:
Gambe e piano interamente in marmo.
Bordi del piano stondati.
Tavolo in legno:
Gambe in massello di tulipier, piano in MDF ultralight con impiallacciatura in legno lati, nelle finiture marrone opaco e naturale opaco.
Bordi del piano smussati.

Table en marbre:
Pieds et plateau entièrement en marbre.
Bords du plateau rajeunis.

Table en bois:
Pieds en tulipier massif, plateau en MDF ultralégers avec placage en bois de lati à l'extérieur, disponibles dans les finitions brun foncé mat et naturel mat.
Bords du plateau biseautés.

Marble table:
Legs and top are entirely in marble.
Rejuvenated and rounded top edge.
Wooden table:
Solid tulipier wood legs, ultralight MDF top with external veneer in lati wood, available in the finishes matt brown and matt natural.
Bevelled top edge.

Русский
Стол мраморный:
Столешница и ножки целиком выполнены из мрамора

Столешница со скругленной кромкой
Стол деревянный:
Ножки: массив тюльпанного дерева, столешница из сверхлегкой МДФ, фанерованной шпоном экзотической породы дерева лати, в натуральной матовой либо коричневой матовой отделке. Кромка столешницы скошенная.

Marmortisch:
Beine und Tischplatte komplett aus Marmor.
Tischplatte mit gerundeten und verjüngten Kanten.
Holztisch:
Beine aus Tulipier massiv, Tischplatte aus MDF ultralight mit äusserem Latifurnier in den Ausführungen braun matt und natur matt.
Tischplatte mit abgeschrägten Kanten.

Hebo _2016_ DESIGN GABRIELE CAPPELLETTI

Tavoli Tables



7HEB101
Marble
7HEB102
Wood
L220 P120 H72



7HEB103
Marble
7HEB104
Wood
L260 P120 H72

Top: marmo/legno, spessore 20 mm
Top: marble/wooden, 20 mm thick

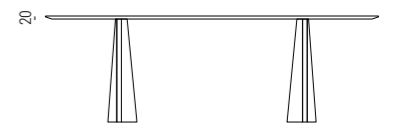

Finiture Finishes

Marmo
Marble



Code

White Carrara marble **OPP1** Black Marquina marble **OPP2** Brown Emperador marble **OPP3** Black and gold marble **OPP9** Arabescato Vagli marble **OPP18** Calacatta Vagli marble **OPP19**

Legno
Wooden



Code

Cherry stained oak **OPR1** Wengé stained oak **OPR2** Walnut stained oak **OPR3** Natural oak **OPR4** Black stained oak **OPR5** Cherry Milano stained oak **OPR6**

Code

Tobacco stained oak **OPR8** Grey taupe stained oak **OPR9** Whitened oak **OPR10** Charcoal stained oak **OPR11** Mahogany stained oak **OPR12** Moka matt stained oak **OPR15**

Jeff _2024_ DESIGN LUCA ERBA

Fusto in legno massello e legno multistrato con cinghie elastiche intrecciate.
 Imbottitura in poliuretano espanso con densità 40 Kg/m³ rivestito in dacron.
 Seduta in poliuretano espanso con densità di 30 Kg/m³, rivestito in dacron. Rivestimento non sfoderabile né in tessuto, né in pelle e finta pelle.

Carcasse en bois massif et multiplis muni de bandes élastiques entrecroisées et finie de mousse de polyuréthane d'une densité de 40 kg/m³ couverte de dacron.
Assise en mousse de polyuréthane d'une densité de 30 kg/m³, couverte de dacron.
Le revêtement est toujours fixe.

Frame made of solid wood and multi-ply wood with interwoven elastic straps, upholstered with polyurethane foam with density of 40 Kg/m³, covered with dacron.
 Seat in polyurethane foam with density of 30 Kg/m³, covered with dacron.
 Fixed fabric, leather and artificial leather covers.

Каркас из массива дерева и фанеры с плетеными эластичными ремнями.
Набивка из пенополиуретана плотностью 40 кг/м³, покрытая лавсаном.
Сиденье из пенополиуретана плотностью 30 кг/м³, покрытое лавсаном.
Несъемный чехол из ткани, кожи или искусственной кожи.

Das Gestell besteht aus Massiv- und Schichtholz, mit geflochtenen Gummigurten, gepolstert mit Polyurethan-Schaumstoff 40 Kg/m³, mit Dacron ummantelt.
 Sitz bestehend aus Polyurethan-Schaumstoff 30 Kg/m³, mit Dacron ummantelt.
 Jeff ist immer festbezogen.

Jeff _2024_ DESIGN LUCA ERBA

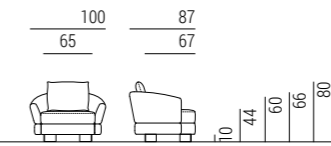

Divani Sofas

Cuscini Cushions

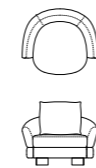

9JE101
L100 P87 H80

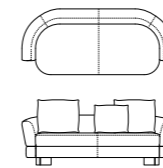

9JE201
L200 P87 H80

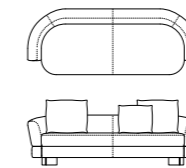

9JE202
L225 P87 H80



9JE102
L45 P45
Cuscinetto in piuma senza fascia
Feather cushion without band



9JE103
L55 P55
Cuscinetto in piuma senza fascia
Feather cushion without band

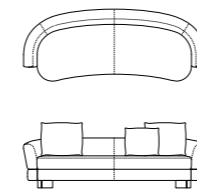

9JE203
L240 P95 H80
Divano curvo
Curved sofa

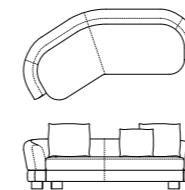

9JE204
L230 P120 H80
Divano angolo
Corner sofa

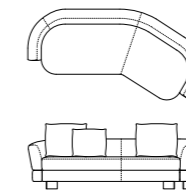

9JE205
L230 P120 H80
Divano angolo
Corner sofa

Finiture Finishes

Base in metallo
Metal base



Code
 Brushed matt chrome metal **OPM2**
 Brushed matt dark grey metal **OPM3**
 RAL 9017 black painted metal **OPM6**
 RAL 9016 white painted metal **OPM7**
 Classic bronze painted metal **OPM9**
 Golden beach painted metal **OPM10**
 Gold pearl painted metal **OPM11**
 Brushed copper metal **OPM12**



Code
 Brushed antique brass metal **OPM13**
 Brushed antique gold metal **OPM15**
 Anodyc bronze metal **OPM18**
 Delabre pewter brushed metal **OPM19**
 Delabre brass brushed metal **OPM20**
 Dark bronze painted metal **OPM21**
 Prosecco painted metal **OPM22**
 Tobacco painted metal **OPM23**

Joy _ 2016 _ DESIGN ELEONORA POZZI

Struttura in tubolare di metallo ricoperto con schiuma di poliuretano a freddo ignifugo, classe 11M, rivestito con una fodera in fibra acrilica. Cuscino di seduta in poliuretano espanso con densità 40 kg/m³ (5,9 KPA), rivestito in fibra acrilica. Il rivestimento è sempre fisso.

Metal tube structure upholstered with cold injected fire retardant polyurethane foam class 11M, covered with acrylic fibre. Seat cushion in polyurethane foam with density 40 kg/m³ (5,9 KPA), lined with acrylic fibre. Fixed covers.

Struktur der Sitzschale in Metall überschäumt mit Polyurethan-Kaltschaumstoff, Feuerwiderstandsklasse 11M, mit Acrylfaser ummantelt. Sitzkissen aus Polyurethan-Schaumstoff mit Dichte 40 Kg/m³ (5,9 KPA), mit Acrylfaser ummantelt. Bezüge immer fix, nicht abziehbar.

Structure en métal tubulaire recouvert de mousse à froid ignifuge classe 11M, recouverte d'une housse en fibre acrylique. Coussin d'assise en mousse de polyuréthane avec une densité de 40 kg/m³ (5,9 kPa), recouverte de fibre acrylique. Le revêtement est toujours fixe.

Каркас выполнен из профильной металлической трубы, покрытой слоем огнестойкого пенополиуретана холодного формования, класс 11M, и помещенной в чехол из акрилового волокна. Наполнение подушки сиденья выполнено из вспененного полиуретана плотностью 40 кг/м³ (5,9 кПа), помещенного в чехол из акрилового волокна. Обивка только несъемная.

Joy _ 2016 _ DESIGN ELEONORA POZZI

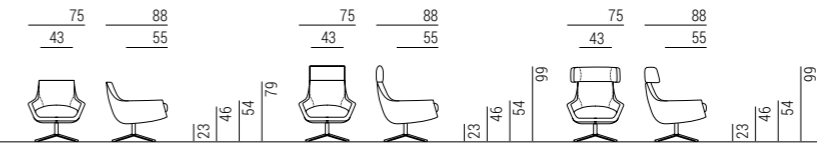

Poltrone girevoli
Swivel armchairs



9JY104
L75 P82 H99
Poltrona girevole con schienale alto
Swivel high wingback chair



9JY101
L75 P82 H99
Poltrona girevole con schienale alto
Swivel armchair with high back



9JY102
L75 P82 H79
Poltrona girevole con schienale basso
Swivel armchair with low back



9JY103
L60 P44 H39
Pouf girevole
Swivel pouf

Basi girevoli
Swivel bases

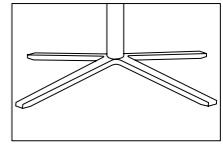

Versione A tubolare in metallo
Version A tubular in metal

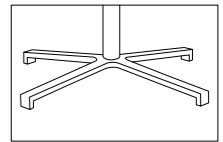

Versione B tubolare in metallo
Version B tubular in metal

Poltrone
Armchairs

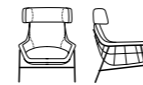

9JY107
L75 P82 H99
Poltrona con schienale alto
High wingback chair



9JY106
L75 P82 H99
Poltrona con schienale alto
Armchair with high back



9JY105
L75 P82 H79
Poltrona con schienale basso
Armchair with low back



9JY108
L75 P82 H79
Poltrona girevole con schienale basso
Swivel armchair with low back

Finiture
Finishes

Base girevole in metallo A
Swivel metal base A

Code



Shiny chrome metal **OPM1** | Brushed matt chrome metal **OPM2** | Brushed matt dark grey metal **OPM3** | RAL 9017 black painted metal **OPM6** | RAL 9016 white painted metal **OPM7** | Classic bronze painted metal **OPM9** | Golden beach painted metal **OPM10** | Gold pearl painted metal **OPM11** | Brushed copper metal **OPM12** | Brushed antique brass metal **OPM13**

Code

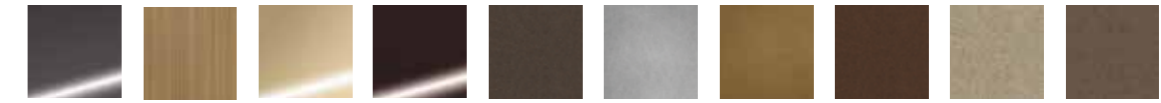

Shiny black chrome metal **OPM14** | Brushed antique gold metal **OPM15** | Shiny brass chrome metal **OPM16** | Bronze metal **OPM17** | Anodyc bronze metal **OPM18** | Delabre pewter brushed metal **OPM19** | Delabre brass brushed metal **OPM20** | Dark bronze painted metal **OPM21** | Prosecco painted metal **OPM22** | Tobacco painted metal **OPM23**

Base girevole in metallo B
Swivel metal base B

Code



Shiny chrome metal **OPM1** | Brushed matt chrome metal **OPM2** | RAL 9017 black painted metal **OPM6** | Classic bronze painted metal **OPM9**

Code



9JY105
9JY106
9JY107
9JY108
Base in metallo
Metal base
RAL 9017 black painted metal **OPM6** | Classic bronze painted metal **OPM9** | Golden beach painted metal **OPM10** | Gold pearl painted metal **OPM11** | Anodyc bronze metal **OPM18**

Kofi _ 2023 _ DESIGN LUCA ERBA

Tavoli
Tables

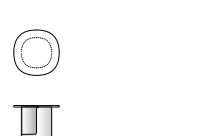

7K0101
Top marmo/Marble top
Base in rovere/Oak base
7K0201
Top vetro/Glass top
Base in rovere/Oak base
L60 P60 H48

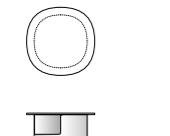

7K0102
Top marmo/Marble top
Base in rovere/Oak base
7K0202
Top vetro/Glass top
Base in rovere/Oak base
L90 P90 H38

Top: marmo, spessore 20 mm
Top: marble, 20 mm thick

Top: vetro, spessore 6 mm
Top: glass, 6 mm thick



Top: Gres Porcellanato, spessore 12 mm
Top: Porcelain Stoneware, 20 mm thick







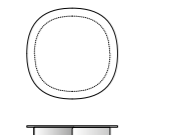







































7K0104
Top marmo/Marble top
Base in rovere/Oak base
7K0204
Top vetro/Glass top
Base in rovere/Oak base
L60 P60 H38



7K0103
Top marmo/Marble top
Base in rovere/Oak base
7K0203
Top vetro/Glass top
Base in rovere/Oak base
L120 P120 H28

Kofi _ 2023 _ DESIGN LUCA ERBA

Finiture
Finishes

Base in metallo Metal base										
Code	Brushed matt chrome metal OPM2	Brushed matt dark grey metal OPM3	RAL 9017 black painted metal OPM6	RAL 9016 white painted metal OPM7	Classic bronze painted metal OPM9	Golden beach painted metal OPM10	Gold pearl painted metal OPM11	Brushed copper metal OPM12		
Code										
Code	Brushed antique brass metal OPM13	Brushed antique gold metal OPM15	Anodyc bronze metal OPM18	Delabre pewter brushed metal OPM19	Delabre brass brushed metal OPM20	Dark bronze painted metal OPM21	Prosecco painted metal OPM22	Tobacco painted metal OPM23		
Top in marmo Marble top										
Code	White Carrara marble OPP1	Black Marquina marble OPP2	Brown Emperador marble OPP3	Grey Serena stone OPP4	Beige Brera stone OPP5	Calacatta marble OPP7	Black and gold marble OPP9	Perfetto brown marble OPP10	Grey Stone marble OPP11	Guatemala green marble OPP12
Code										
Code	Velvet brown marble OPP13	Amani Bronze marble OPP14	Covelano white marble OPP15	Sahara noir marble OPP16	Port Laurent marble OPP17	Arabescato orobico grey marble OPP20	Calacatta violet marble OPP21	Travertino marble OPP22		
Top in Gres Porcellanato Porcelain Stoneware Top										
Code	Nero Marquina OPG2	Statuario Supremo OPG6								
Top in vetro Glass top										
Code	RAL 9016 traffic white back-painted glass OPV3	RAL 9017 traffic black back-painted glass OPV4	RAL 7044 silk grey back-painted glass OPV5	RAL 1019 grey beige back-painted glass OPV6	Chrome back-painted bronze glass OPV9	Chrome back-painted grey glass OPV10				

Kyle _2025_ DESIGN LUCA ERBA

Tavoli
Tables

36
32



7KYL101
Top marmo/Marble top
ø36 H50

Top: marmo, spessore 20 mm
Top: marble, 20 mm thick



Kyle _2025_ DESIGN LUCA ERBA

Finiture
Finishes

Top in marmo
Marble top



Code	White Carrara marble OPP1	Black Marquinia marble OPP2	Brown Emperador marble OPP3	Grey Serena stone OPP4	Beige Brera stone OPP5	Calacatta marble OPP7	Black and gold marble OPP9	Perfetto brown marble OPP10	Grey Stone marble OPP11	Guatemala green marble OPP12
-------------	-------------------------------------	---------------------------------------	---------------------------------------	----------------------------------	----------------------------------	---------------------------------	--------------------------------------	---------------------------------------	-----------------------------------	--

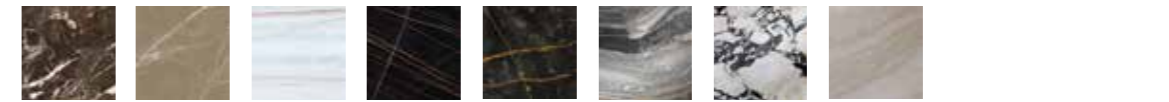

Code	Velvet brown marble OPP13	Amani Bronze marble OPP14	Covelano white marble OPP15	Sahara noir marble OPP16	Port Laurent marble OPP17	Arabescato orobico grey marble OPP20	Calacatta violet marble OPP21	Travertino marble OPP22
-------------	-------------------------------------	-------------------------------------	---------------------------------------	------------------------------------	-------------------------------------	--	---	-----------------------------------

Top in Gres Porcellanato
Porcelain Stoneware Top



Code	Nero Marquinia OPG2	Statuario Supremo OPG6
-------------	-------------------------------	----------------------------------

Base in metallo
Metal base



Code	Shiny chrome metal OPM1	RAL 9017 black painted metal OPM6	RAL 9016 white painted metal OPM7	Classic bronze painted metal OPM9	Golden beach painted metal OPM10	Gold pearl painted metal OPM11	Shiny black chrome metal OPM14	Brushed antique gold metal OPM15
-------------	-----------------------------------	---	---	---	--	--	--	--

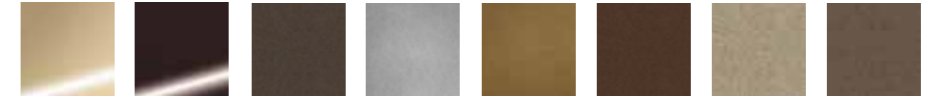

Code	Shiny brass chrome metal OPM16	Bronze metal OPM17	Anodyc bronze metal OPM18	Delabre pewter brushed metal OPM19	Delabre brass brushed metal OPM20	Dark bronze painted metal OPM21	Prosecco painted metal OPM22	Tobacco painted metal OPM23
-------------	--	------------------------------	-------------------------------------	--	---	---	--	---------------------------------------

Kyoto _2023_ DESIGN PAOLO SALVADÈ

Tavolini Coffee tables

7KY101 Top marmo/Marble top 7KY102 Top vetro/Glass top Ø40 H48	7KY103 Top marmo/Marble top 7KY104 Top vetro/Glass top Ø50 H38	7KY105 Top marmo/Marble top 7KY106 Top vetro/Glass top Ø50 H48

7KY107 Top marmo/Marble top 7KY108 Top vetro/Glass top Ø80 H38	7KY109 Top marmo/Marble top 7KY110 Top vetro/Glass top Ø100 H38	7KY111 Top marmo/Marble top 7KY112 Top vetro/Glass top L120 P60 H38	7KY113 Top marmo/Marble top 7KY114 Top vetro/Glass top L80 P80 H38

Tavoli da pranzo Dining tables

7KY201 Top marmo/Marble top 7KY202 Top legno/Wooden top L200 P110 H74	7KY203 Top marmo/Marble top 7KY204 Top legno/Wooden top L220 P110 H74	7KY205 Top marmo/Marble top 7KY206 Top legno/Wooden top L250 P110 H74

Madia Sideboard

7KY207 Top superiore in marmo Marble upper top 7KY307 Top superiore in vetro Glass upper top L220 P50 H71	7KY212 Top superiore in marmo Marble upper top 7KY312 Top superiore in vetro Glass upper top L220 P50 H71	7KY208 Top superiore in marmo Marble upper top 7KY308 Top superiore in vetro Glass upper top L220 P50 H50

Credenza Cupboard

7KY209 Top superiore in marmo Marble upper top 7KY309 Top superiore in vetro Glass upper top L100 P50 H125	7KY211 Top superiore in marmo Marble upper top 7KY311 Top superiore in vetro Glass upper top L100 P50 H125	7KY210 Top superiore in marmo Marble upper top 7KY310 Top superiore in vetro Glass upper top L100 P50 H105

Top: Gres Porcellanato, spessore 20 mm
Top: Porcelain Stoneware, 20 mm thick

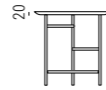

Top: marmo, spessore 20 mm
Top: marble, 20 mm thick

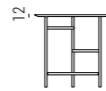

Top: vetro extra light temperato, spessore 6 mm
Top: extralight tempered glass, 6 mm thick

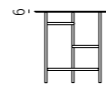

Finiture Finishes

Top in marmo
Marble top

Code White Carrara marble OPP1	Code Black Marquina marble OPP2	Code Brown Emperador marble OPP3	Code Grey Serena stone OPP4	Code Beige Brera stone OPP5	Code Calacatta marble OPP7	Code Black and gold marble OPP9	Code Perfetto brown marble OPP10	Code Grey Stone marble OPP11	Code Guatemala green marble OPP12

Code Velvet brown marble OPP13	Code Amani Bronze marble OPP14	Code Covelano white marble OPP15	Code Sahara noir marble OPP16	Code Port Laurent marble OPP17	Code Arabescato orobico grey marble OPP20	Code Calacatta violet marble OPP21	Code Travertino marble OPP22

Top in Gres Porcellanato
Porcelain Stoneware Top

Code Nero Marquina OPG2	Code Statuario Supremo OPG6

Top in vetro
Glass top

Code Transparent glass OPV1	Code Frosted glass OPV2	Code RAL 9016 traffic white back-painted glass OPV3	Code RAL 9017 traffic black back-painted glass OPV4	Code RAL 7044 silk grey back-painted glass OPV5	Code RAL 1019 grey beige back-painted glass OPV6	Code Chrome back-painted bronze glass OPV9	Code Chrome back-painted grey glass OPV10	Code Transparent bronze glass OPV12	Code Transparent grey glass OPV13

Struttura media/credenza
Sideboard/cupboard structure

Code Cherry stained oak OPR1	Code Wengé stained oak OPR2	Code Walnut stained oak OPR3	Code Natural oak OPR4	Code Black stained oak OPR5	Code Cherry Milano stained oak OPR6

Code Tobacco stained oak OPR8	Code Grey taupe stained oak OPR9	Code Whitened oak OPR10	Code Charcoal stained oak OPR11	Code Mahogany stained oak OPR12	Code Moka matt stained oak OPR15

Base e maniglie in metallo
Metal base and handles

Code Shiny chrome metal OPM1	Code Brushed matt chrome metal OPM2	Code Brushed matt dark grey metal OPM3	Code RAL 9017 black painted metal OPM6	Code RAL 9016 white painted metal OPM7	Code Classic bronze brushed metal OPM9	Code Golden beach painted metal OPM10	Code Gold pearl painted metal OPM11	Code Brushed copper metal OPM12	Code Brushed antique brass metal OPM13

Code Shiny black chrome metal OPM14	Code Brushed antique gold metal OPM15	Code Shiny brass chrome metal OPM16	Code Bronze metal OPM17	Code Anodyc bronze metal OPM18	Code Delabre pewter brushed metal OPM19	Code Delabre brass brushed metal OPM20	Code Dark bronze painted metal OPM21	Code Prosecco painted metal OPM22	Code Tobacco painted metal OPM23

Kyoto _2023_ DESIGN PAOLO SALVADÈ

Leaf _2009_ DESIGN STUDIO MARELLI

Tavoli
Tables



7LE101
Server in metallo
Metal server
L64 P25 H51

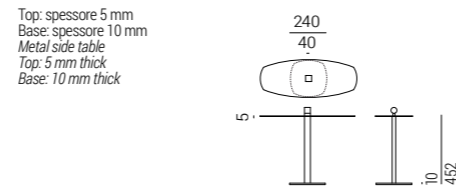

Finiture
Finishes

Metallo Metal							
Code	Shiny chrome metal OPM1	Brushed matt chrome metal OPM2	Brushed matt dark grey metal OPM3	RAL 9017 black painted metal OPM6	RAL 9016 white painted metal OPM7	Metal painted in RAL Classic colors OPM8	Classic bronze painted metal OPM9
Code	Golden beach painted metal OPM10	Gold pearl painted metal OPM11	Brushed copper metal OPM12	Brushed antique brass metal OPM13	Shiny black chrome metal OPM14	Brushed antique gold metal OPM15	Shiny brass chrome metal OPM16
Code	Bronze metal OPM17	Anodyc bronze metal OPM18	Delabre pewter brushed metal OPM19	Delabre brass brushed metal OPM20	Dark bronze painted metal OPM21	Prosecco painted metal OPM22	Tobacco painted metal OPM23

Linda _2022_ DESIGN LUCA ERBA

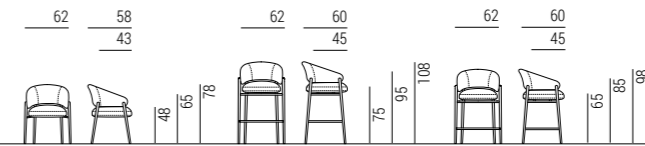

Schienale in legno multistrato di pioppo curvato imbottito con poliuretano espanso con densità 30 kg/m³. Seduta in legno multistrato di pioppo imbottito con poliuretano espanso 40 kg/m³, rivestito in dacron con cinghie elastiche intrecciate.

Backrest made of curved multi-ply poplar wood, upholstered with polyurethane foam with density 30 kg/m³. Seat structure made of multi-ply poplar wood, upholstered with polyurethane foam with density of 40 kg/m³, covered with dacron, with interwoven elastic belts.

Rückenlehne aus gebogenem Pappelschichtholz, gepolstert mit Polyurethan-Schaumstoff mit Dichte 30 Kg/m³. Sitzstruktur aus Pappelschichtholz, gepolstert mit Polyurethan-Schaumstoff mit Dichte 40 Kg/m³, mit Dacron ummantelt, mit geflochtenen Gummigurten.

Dossier en bois multiplis de peuplier courbé fini de mousse de polyuréthane de densité de 30 kg/m³. Structure de l'assise en bois multiplis de peuplier finie de mousse de polyuréthane de densité de 40 kg/m³ couverte de dacron, muni de bandes élastiques entrecroisées.

Для изготовления спинки используется гнутая многослойная фанера из тополя с наполнением из вспененного полиуретана плотностью 30 кг/м³. Конструкция сиденья: многослойная фанера из тополя с наполнением из вспененного полиуретана плотностью 40 кг/м³, обернутого в дакрон, в сочетании с перекрещивающимися эластичными ремнями.

Poltrone e sgabelli
Armchairs, barstools and counter stools

9LIN101 L62 P58 H78 Base in metallo verniciato Base in painted metal	9LIN102 L62 P58 H78 Base in metallo in altre finiture Metal base in other finishes	9LIN103 L62 P60 H108 Base in metallo verniciato Base in painted metal	9LIN104 L62 P60 H108 Base in metallo in altre finiture Metal base in other finishes	9LIN105 L62 P60 H98 Base in metallo verniciato Base in painted metal	9LIN106 L62 P60 H98 Base in metallo in altre finiture Metal base in other finishes

Finiture
Finishes

Base in metallo Metal base (9LIN101 - 9LIN103)									
Code	RAL 9017 black painted metal OPM6	RAL 9016 white painted metal OPM7	Classic bronze painted metal OPM9	Golden beach painted metal OPM10	Gold pearl painted metal OPM11	Anodyc bronze metal OPM18	Dark bronze painted metal OPM21		
Base in metallo Metal base (9LIN102 - 9LIN104)									
Code	Brushed matt chrome metal OPM2	Brushed copper metal OPM12	Brushed matt dark grey metal OPM3	Brushed antique brass metal OPM13	Brushed antique gold metal OPM15	Delabre pewter brushed metal OPM19	Delabre brass brushed metal OPM20	Prosecco painted metal OPM22	Tobacco painted metal OPM23

Lua _ 2024 _ DESIGN LUCA ERBA

Tavoli
Tables



7LU201
Top marmo/Marble top
ø60 H25

7LU202
Top marmo/Marble top
ø60 H35

7LU203
Top marmo/Marble top
ø60 H48

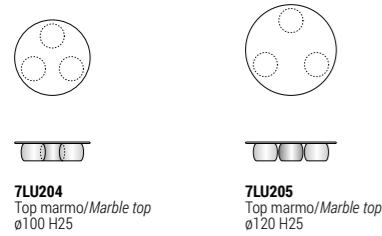

7LU204
Top marmo/Marble top
ø100 H25

7LU205
Top marmo/Marble top
ø120 H25

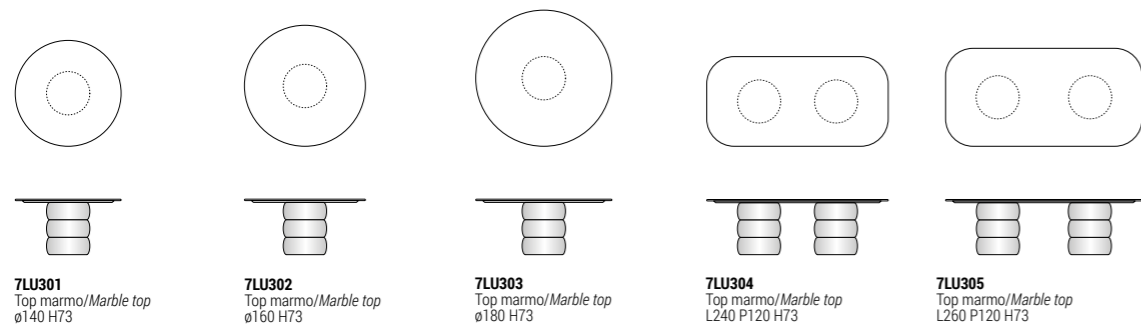

7LU301
Top marmo/Marble top
ø140 H73

7LU302
Top marmo/Marble top
ø160 H73

7LU303
Top marmo/Marble top
ø180 H73

7LU304
Top marmo/Marble top
L240 P120 H73

7LU305
Top marmo/Marble top
L260 P120 H73

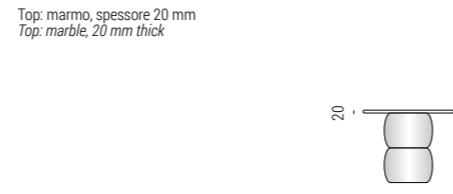

Top: marmo, spessore 20 mm
Top: marble, 20 mm thick

Lua _ 2024 _ DESIGN LUCA ERBA

Finiture
Finishes

Top in marmo Marble top										
Code	White Carrara marble OPP1	Black Marquina marble OPP2	Brown Emperador marble OPP3	Grey Serena stone OPP4	Beige Brera stone OPP5	Calacatta marble OPP7	Black and gold marble OPP9	Perfetto brown marble OPP10	Grey Stone marble OPP11	Guatemala green marble OPP12
Code	Velvet brown marble OPP13	Amani Bronze marble OPP14	Covelano white marble OPP15	Sahara noir marble OPP16	Port Laurent marble OPP17	Arabescato orobico grey marble OPP20	Calacatta violet marble OPP21	Travertino marble OPP22		
Base: MDF verniciato finitura metallica Base: MDF base painted in metal finishing										
Code	RAL 9017 black OPM6	RAL 9016 white OPM7	Classic bronze OPM9	Golden beach OPM10	Gold pearl OPM11	Brushed copper OPM12				
Code	Brushed antique brass OPM13	Brushed antique gold OPM15	Anodyc bronze OPM18	Delabre pewter brushed OPM19	Delabre brass brushed OPM20	Dark bronze OPM21	Prosecco painted metal OPM22	Tobacco painted metal OPM23		
Base: MDF verniciato lucido Base: MDF Shiny painted										
	Beige	Cammello	Ottanio	Prugna	Pesca	Ocra	Caramello			

Matheus _2015_ DESIGN STUDIO MARELLI

Fusto in legno massello e legno multistrato con cinghie elastiche intrecciate. Imbottitura in poliuretano espanso rivestito in vellutino bianco. Cuscini di schienale in Piumafib, una speciale miscela ipoallergenica di vera piuma e fibra poliestere siliconata*. Cuscini di seduta costituiti da un inserto in poliuretano con densità di 30 Kg/m³ ricoperto da un trapuntino di vera piuma imbottito a scomparti*. Completamente sfoderabile in tessuto, non sfoderabile in pelle e finta pelle.
Kit letto non disponibile.

*Manutenzione dei cuscini contenenti piuma: I cuscini contenenti piuma tendono a deformarsi con l'utilizzo. Per mantenerne la forma è necessario, anche dopo un breve utilizzo, battere e sprimacciare ripetutamente i cuscini. Non utilizzare mai battipanni o aspirapolvere. A coloro che non desiderassero seguire queste indicazioni o che volessero un divano dall'aspetto meno vissuto, raccomandiamo di preferire dei cuscini in gomma.

Carcasse en bois massif et multiplis muni de bandes élastiques entrecroisées et finie de mousse polyuréthane couverte de dacron. Coussins de dossier en Piumafib, un mélange hypoallergénique spécial de véritable duvet et fibre polyester siliconisée. Les coussins d'assise sont composés d'un noyau en mousse polyuréthane d'une densité de 30 kg/m³ couvert de véritable duvet broché en compartiments*. Revêtement complètement déhoussable en tissu, fixe en cuir et cuir look. Pas disponible en canapé-lit.*

*Entretien de coussins en duvet: Coussins en duvet ont tendance à perdre leur forme dû à l'usage. Pour en conserver la forme il est nécessaire, aussi après un usage court, de régulièrement battre les coussins. Ne jamais utiliser la tapette ou l'aspirateur. A ceux qui ne désirent pas suivre ces indications ou qui souhaitent un canapé qui ait l'air moins "usé", nous conseillons vivement de choisir des coussins en mousse polyuréthane.

Frame made of solid wood and multi-ply wood with interwoven elastic straps. The upholstery is made of polyurethane foam, covered with dacron. The back cushions are filled with Piumafib, a special hypoallergenic mixture of feathers and siliconised polyfibre. The seat cushions are made of a foam insert with density of 30 Kg/m³, covered with a feather compartments quilt*. Fully removable fabric covers, fixed leather and artificial leather covers. Sofa-bed is not available.*

*Maintenance of feather cushions: Cushions filled with feathers tend to change their shape with use. In order to keep their shape it is necessary, even after a short use, to plump up the cushions repeatedly. Never use carpet beater or vacuum cleaner. We recommend to choose foam cushions to those who do not wish to follow these instructions or to have a "used look" sofa.

Для производства каркаса используется массив дерева и многослойная фанера в сочетании с перекрещивающимися эластичными ремнями. Наполнение из полиуретана, обернутого в белый бархат. Наполнение подушек спинки выполнено из материала Piumafib – специальной, не вызывающей аллергии смеси из натурального пуха и полиэфирных силиконовых волокон. Подушки сиденья: стеганые по отсекам, наполнение из натурального пуха с вставками из полиуретана плотностью 30 кг/м³ *. Полностью съемные чехлы из ткани, несъемные чехлы из кожи.*

Das Gestell besteht aus Massiv- und Schichtholz, mit geflochtenen Gummigurten, gepolstert mit Polyurethanschaumstoff, mit Dacron bezogen. Rueckenkissen aus Piumafib, einer hypoallergischen speziellen Mischung aus echter Daune und silikonisierter Polyesterfaser. Die Sitzkissen bestehen aus einem Schaumkern mit Dichte 30 Kg/m³ mit einer gekammerten Daunenauflage*. Stoffbezüge alle abziehbar, Leder und Kunstleder festbezogen. Als Bettsofa nicht verfügbar. Wartungsanleitungen fuer Daunenkissen: Die Kissen, die Daunen enthalten, neigen dazu, sich durch Gebrauch zu verformen. Um die ursprungliche Form zu halten, ist es notwendig, auch nach kurzem Gebrauch, die Kissen wiederholt aufzuschuettern. Keinen Ausklopfper oder Staubsauger verwenden. Unseren Kunden, die diese Anweisungen nicht befolgen moechten, oder die kein Sofa mit solchem "gebrauchten" Aussehen haben moechten, empfehlen wir Polyurethan-Kissen.*

*Вариант со спальным местом не предусмотрен. *Эксплуатация подушек с пуховым наполнением: В процессе эксплуатации подушки с пуховым наполнением могут деформироваться, во избежание чего их необходимо слегка взбивать вручную даже после непродолжительного нахождения на диване. Использование в этих целях пылесоса или выбивалки для одежды категорически запрещено. Если клиент не планирует следовать данным инструкциям и хочет, чтобы подушки сиденья и спинки проминались по минимуму, посоветуйте выбрать наполнение только из полиуретана, полностью исключив натуральный пух.*

Matheus _2015_ DESIGN STUDIO MARELLI

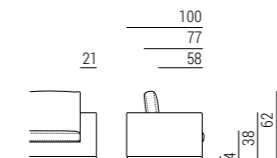

Divani Sofas

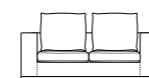

9MU201
L180 P100 H88



9MU202
L200 P100 H88

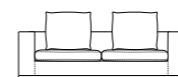

9MU203
L220 P100 H88



9MU204
L240 P100 H88



9MU205
L260 P100 H88

Elementi componibili Modular elements

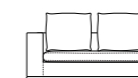

9MU206
L160 P100 H88

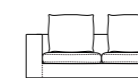

9MU207
L180 P100 H88

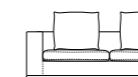

9MU208
L200 P100 H88

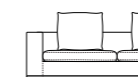

9MU209
L220 P100 H88

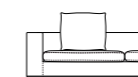

9MU210
L240 P100 H88



9MU212
L140 P100 H88



9MU213
L160 P100 H88



9MU214
L180 P100 H88



9MU215
L200 P100 H88



9MU216
L100 P100 H88
Elemento angolare
Corner element

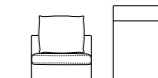

9MU220
L80 P100 H88

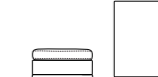

9MU221
L80 P100 H88

Matheus _2015_ DESIGN STUDIO MARELLI

Dormeuse
Longchair

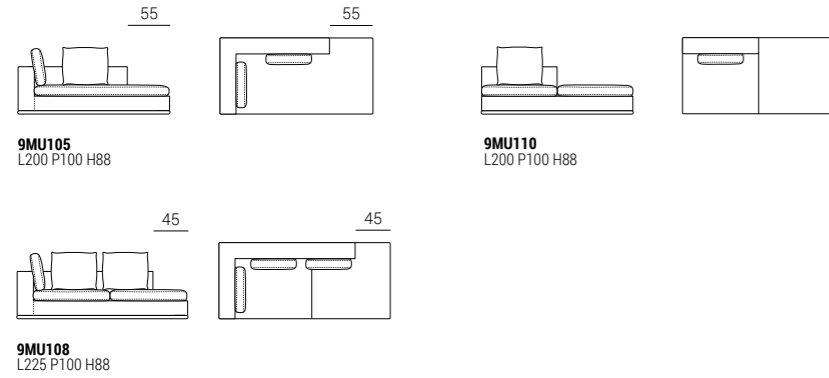

Pouf e accessori
Ottomans and accessories



Matheus _2015_ DESIGN STUDIO MARELLI

Finiture base metallo
Metal base finishes

Code	Shiny chrome metal OPM1	Brushed matt chrome metal OPM2	Brushed matt dark grey metal OPM3	RAL 9017 black painted metal OPM6	Classic bronze painted metal OPM9	Golden beach painted metal OPM10	Gold pearl painted metal OPM11	Brushed copper metal OPM12	Brushed antique brass metal OPM13	
Code	Shiny black chrome metal OPM14	Brushed antique gold metal OPM15	Shiny brass chrome metal OPM16	Bronze metal OPM17	Anodyc bronze metal OPM18	Dark bronze painted metal OPM21	Delabre pewter brushed metal OPM19	Delabre brass brushed metal OPM20	Prosecco painted metal OPM22	Tobacco painted metal OPM23

Milo _2023_ DESIGN LUCA ERBA

Fusto in legno massello e legno multistrato con cinghie elastiche intrecciate.
 Imbottitura della seduta in poliuretano espanso con densità 40 kg/m³ rivestito in dacron.
 Imbottitura dello schienale in poliuretano espanso a quote differenziate con densità di 30 kg/m³ e 40 kg/m³, rivestito in dacron.
 Rivestimento fisso.

Carcasse en bois massif et multiplis munie de bandes élastiques entrecroisées.
 Assise rembourrée en mousse de polyuréthane d'une densité de 40 kg/m³ couverte de dacron.
 Dossier rembourré en mousse polyuréthane de différentes densités de 30 kg/m³ et 40 kg/m³ couverte de dacron.
 Revêtement fixe.

Frame made of solid wood and plywood with interwoven elastic belts.
 Seat upholstered with polyurethane foam with density of 40 kg/m³, covered with dacron.
 Back upholstered with polyurethane foam with different densities of 30 kg/m³ and 40 kg/m³, covered with dacron.
 Fixed covers.

Для производства каркаса используется массив дерева и многослойная фанера в сочетании с перекрещивающимися эластичными ремнями. Наполнение сиденья из вспененного пенополиуретан плотностью - 30 кг/м³, обернутого в дакрон.
 Наполнение спинки из вспененного пенополиуретана различной степени плотности - 30 кг/м³ и 40 кг/м³, обернутого в дакрон.
 Чехлы несъемные.

Das Gestell besteht aus Massiv- und Schichtholz, mit geflochtenen Gummigurten.
 Sitz gepolstert mit Polyurethan-Schaumstoff 40 Kg/m³, mit Dacron bezogen.
 Rücken gepolstert mit Polyurethan-Schaumstoff in verschiedenen Dichten 30 Kg/m³ und 40 Kg/m³, mit Dacron bezogen.
 Ribot ist immer festbezogen.

Milo _2023_ DESIGN LUCA ERBA

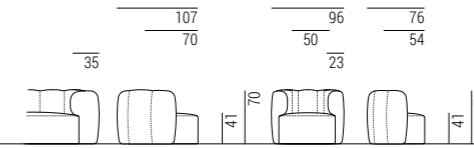
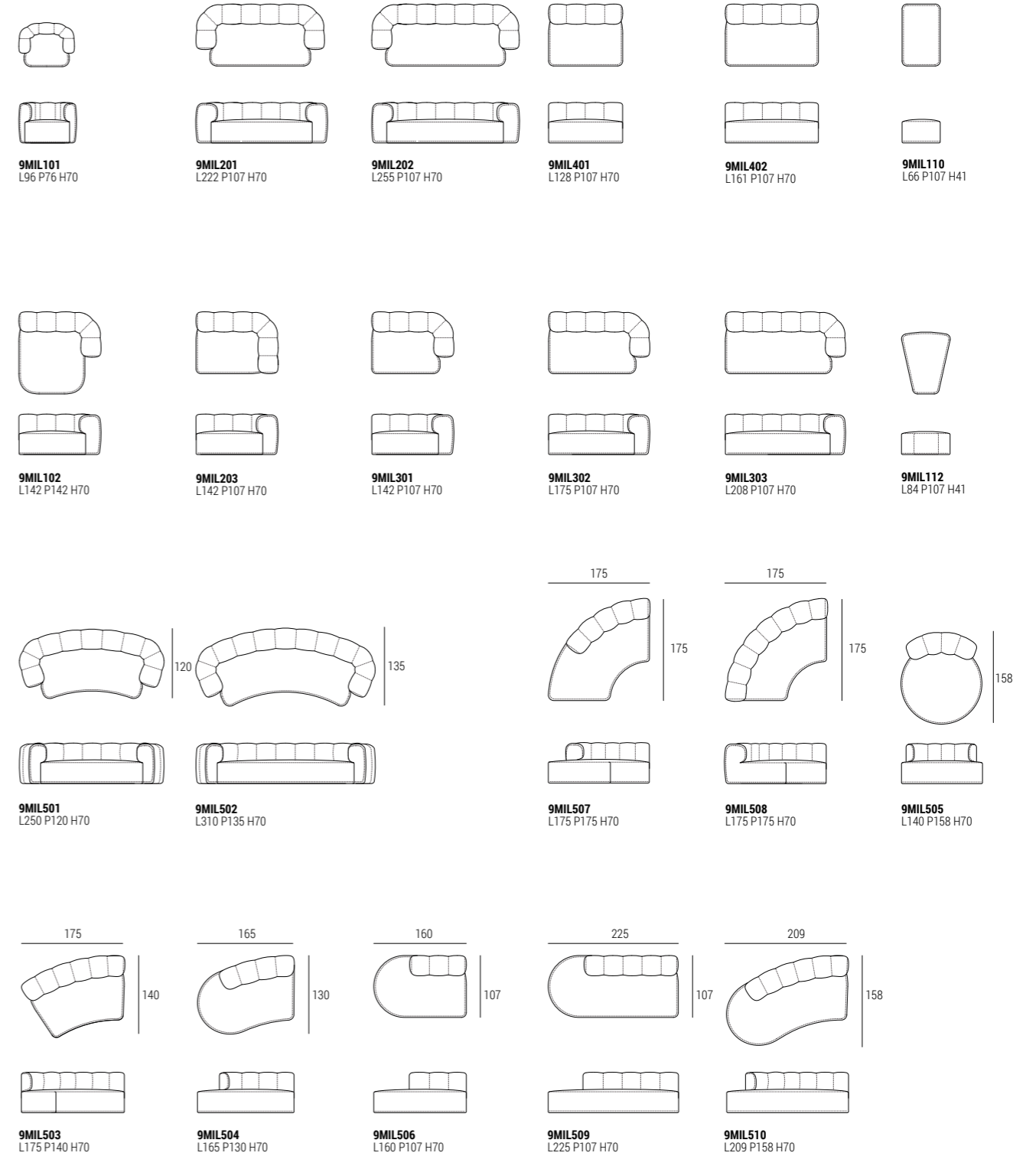
Elementi di seduta
Seat elementsPouf
Ottomans

Milo Bed _2024_ DESIGN LUCA ERBA

Struttura costituita da pannelli composti da particelle di legno, principalmente pioppo e abete.
Imbottitura in poliuretano indeformabile rivestito in dacron.
Rete con struttura in tubo di ferro e doghe in faggio.
Disponibile in tre diverse larghezze, anche con vano contenitore sotto la rete del letto.
Rivestimento sfoderabile in tessuto, non sfoderabile in pelle e finta pelle.

Structure consisting of panels composed of wood particles, mainly poplar and fir.
Padding in non-deformable polyurethane covered in dacron.
Bed base with structure in iron tube and beech slats.
Available in three different widths, also with storage compartment under the bed base.
Removable cover in fabric, non-removable in leather and artificial leather.

Struktur bestehend aus Platten aus Holzpartikeln, hauptsächlich Pappel und Tanne.
Polsterung aus unverformbarem, mit Dacron überzogenem Polyurethan.
Lattenrost mit Struktur aus Eisenrohr und Buchenlatten.
Erhältlich in drei verschiedenen Breiten, auch mit Bettkasten unter dem Lattenrost.
Abnehmbarer Bezug aus Stoff, nicht abziehbar aus Leder und Kunstleder.

Structure composée de panneaux composés de particules de bois, principalement de peuplier et de sapin.
Rembourrage en polyuréthane indéformable recouvert de dacron.
Sommier avec structure en tube de fer et lattes de hêtre.
Disponible en trois largeurs différentes, également avec compartiment de rangement sous le sommier.
Revêtement déhoussable en tissu, non déhoussable en cuir et simili cuir.

Letti Beds

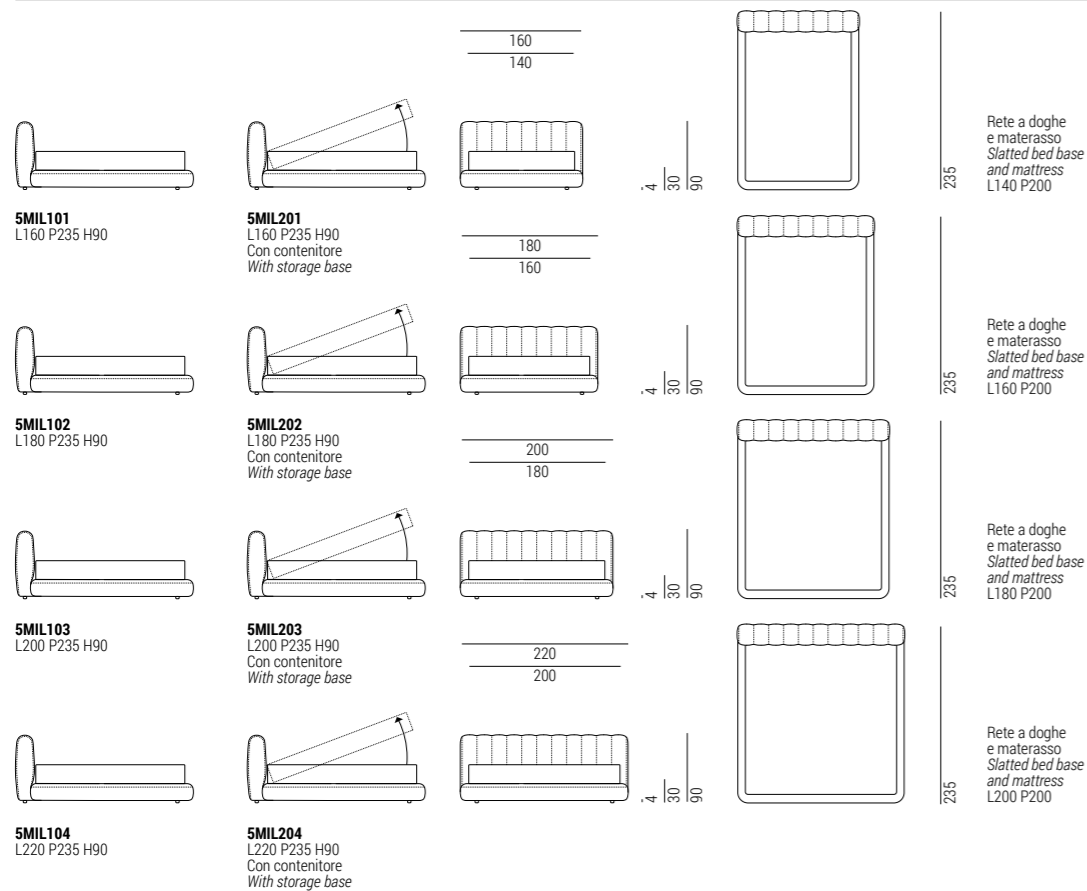

Milo Bed _2024_ DESIGN LUCA ERBA

Panca Bench

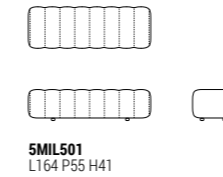

Letti con schienale ampio Beds with wide backrests

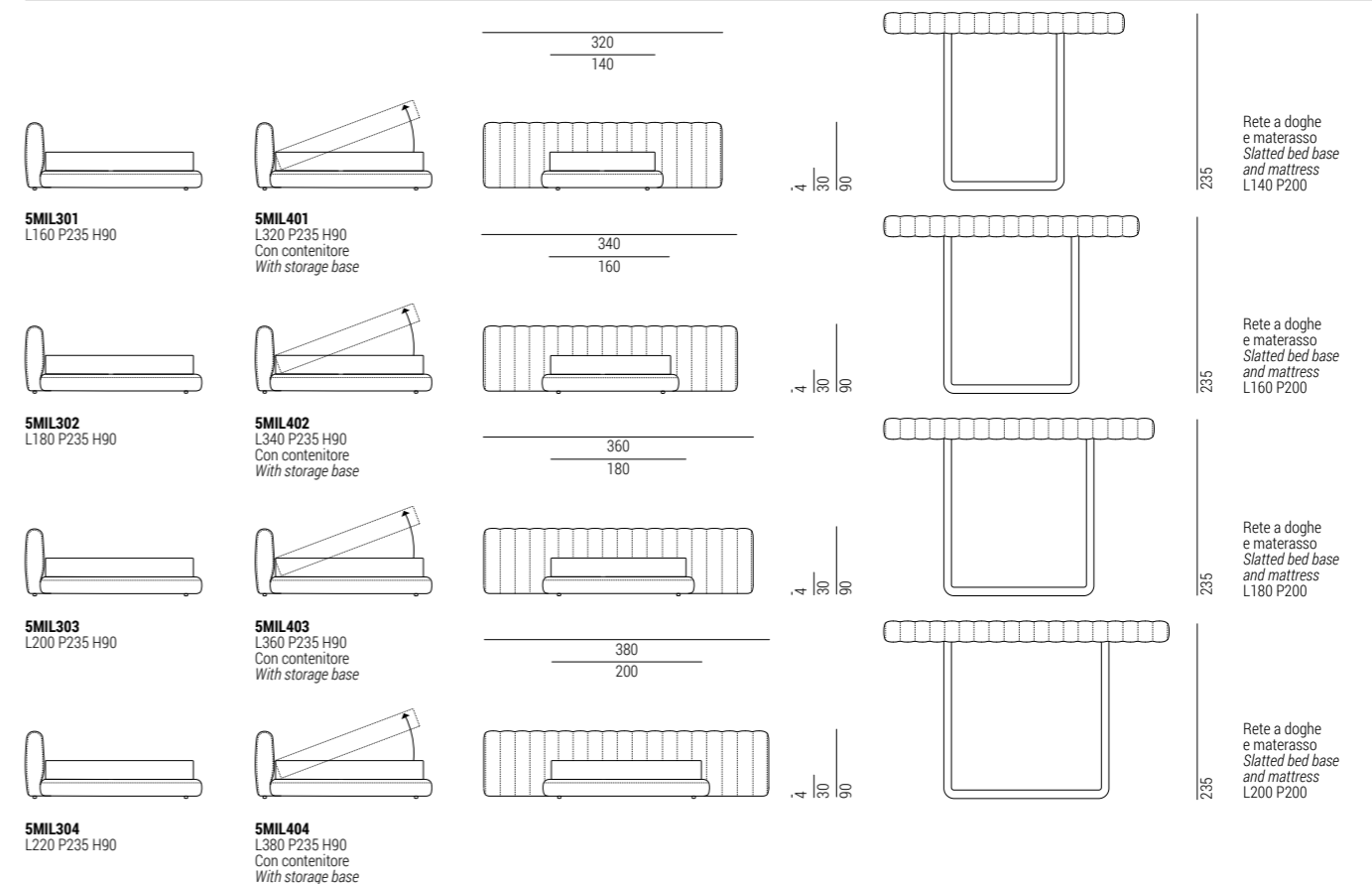

Moon _ 2019 _ DESIGN STUDIO MARELLI

Fusto in legno massello e legno multistrato con cinghie elastiche intrecciate.
 Imbottitura della seduta in poliuretano espanso con densità 40 kg/m³ rivestito in dacron.
 Imbottitura dello schienale in poliuretano espanso a quote differenziate con densità di 30 kg/m³ e 40 kg/m³, rivestito in dacron.
 Rivestimento fisso.

*Carcasse en bois massif et multiplis munie de bandes élastiques entrecroisées.
 Assise rembourrée en mousse de polyuréthane d'une densité de 40 kg/m³ couverte de dacron.
 Dossier rembourré en mousse polyuréthane de différentes densités de 30 kg/m³ et 40 kg/m³ couverte de dacron.
 Revêtement fixe.*

Frame made of solid wood and plywood with interwoven elastic belts.
 Seat upholstered with polyurethane foam with density of 40 kg/m³, covered with dacron.
 Back upholstered with polyurethane foam with different densities of 30 kg/m³ and 40 kg/m³, covered with dacron.
 Fixed covers.

*Для производства каркаса используется массив дерева и многослойная фанера в сочетании с перекрещивающимися эластичными ремнями. Наполнение сиденья из вспененного пенополиуретан плотностью - 30 кг/м³, обернутого в дакрон.
 Наполнение спинки из вспененного пенополиуретана различной степени плотности - 30 кг/м³ и 40 кг/м³, обернутого в дакрон.
 Чехлы несъемные.*

Das Gestell besteht aus Massiv- und Schichtholz, mit geflochtenen Gummigurten.
 Sitz gepolstert mit Polyurethan-Schaumstoff 40 Kg/m³, mit Dacron bezogen.
 Rücken gepolstert mit Polyurethan-Schaumstoff in verschiedenen Dichten 30 Kg/m³ und 40 Kg/m³, mit Dacron bezogen.
 Ribot ist immer festbezogen.

Moon _ 2019 _ DESIGN STUDIO MARELLI

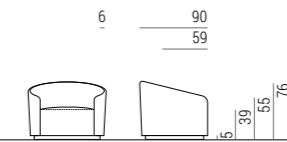

Divani Sofas



9MN101
L98 P90 H76



9MN103
L98 P90 H76
Poltrona girevole
Swivel armchair

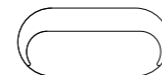

9MN201
L200 P90 H76

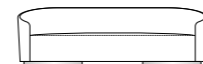
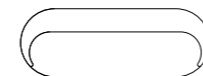

9MN202
L250 P90 H76



9MN203
L245 P120 H76



9MN204
L305 P120 H76



9MN208
L201 P90 H76



9MN209
L246 P90 H76

Elementi componibili Modular elements



9MN206
L106 P90 H76



9MN207
L156 P90 H76



9MN208
L201 P90 H76



9MN209
L246 P90 H76

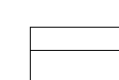

9MN210
L130 P90 H76



9MN205
L180 P156 H76



9MN111
L132,2 P114,5 H76



9MN211
L220 P185 H76

Pouf e accessori Ottomans and accessories



9MN102
Ø60 H40

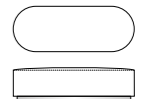

9MN104
L160 P60 H40

Cuscino in piuma senza fascia
 Feather back cushion without band



9CU106
L45 P45

Finiture Finishes

Base metallo Metal base

Code	Shiny chrome metal OPM1	Brushed matt chrome metal OPM2	Brushed matt dark grey metal OPM3	RAL 9017 black painted metal OPM6	Classic bronze painted metal OPM9	Golden beach painted metal OPM10	Gold pearl painted metal OPM11	Brushed copper metal OPM12	Brushed antique brass metal OPM13	Shiny black chrome metal OPM14
Code	Brushed antique gold metal OPM15	Shiny brass chrome metal OPM16	Bronze metal OPM17	Anodized bronze metal OPM18	Delabre pewter brushed metal OPM19	Delabre brass brushed metal OPM20	Dark bronze painted metal OPM21	Prosecco painted metal OPM22	Tobacco painted metal OPM23	

Noah _ 2021 _ DESIGN LUCA ERBA

Fusto in legno massello e legno multistrato con cinghie elastiche intrecciate.
 Imbottitura della seduta in poliuretano espanso con densità 40 kg/m³ rivestito in dacron.
 Imbottitura dello schienale in poliuretano espanso a quote differenziate con densità di 30 kg/m³ e 40 kg/m³, rivestito in dacron.
 Rivestimento fisso.

Carcasse en bois massif et multiplis munie de bandes élastiques entrecroisées.
Assise rembourrée en mousse de polyuréthane d'une densité de 40 kg/m³ couverte de dacron.
Dossier rembourré en mousse polyuréthane de différentes densités de 30 kg/m³ et 40 kg/m³ couverte de dacron.
 Revêtement fixe.

Frame made of solid wood and plywood with interwoven elastic belts.
 Seat upholstered with polyurethane foam with density of 40 kg/m³, covered with dacron.
 Back upholstered with polyurethane foam with different densities of 30 kg/m³ and 40 kg/m³, covered with dacron.
 Fixed covers.

Для производства каркаса используется массив дерева и многослойная фанера в сочетании с перекрещивающимися эластичными ремнями. Наполнение сиденья из вспененного пенополиуретан плотностью - 30 кг/м³, обернутого в дакрон.
 Наполнение спинки из вспененного пенополиуретана различной степени плотности - 30 кг/м³ и 40 кг/м³, обернутого в дакрон.
 Чехлы несъемные.

Das Gestell besteht aus Massiv- und Schichtholz, mit geflochtenen Gummigurten.
 Sitz gepolstert mit Polyurethan-Schaumstoff 40 Kg/m³, mit Dacron bezogen.
 Rücken gepolstert mit Polyurethan-Schaumstoff in verschiedenen Dichten 30 Kg/m³ und 40 Kg/m³, mit Dacron bezogen.
 Ribot ist immer festbezogen.

Noah _ 2021 _ DESIGN LUCA ERBA

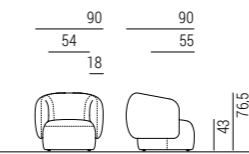
Divani
Sofas

9NH101
L90 P90 H76,5



9NH104
L90 P90 H76,5
Poltrona con base girevole
Armchair with swivel base

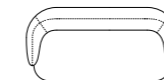

9NH201
L200 P100 H76,5



9NH301
L250 P115 H76,5

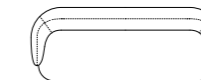

9NH202
L250 P100 H76,5

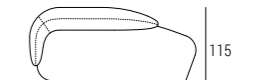
Dormeuse sinistra
Left longchair

9NH102
L220 P115 H76,5

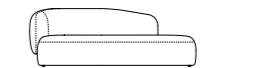
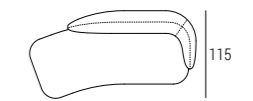
Dormeuse destra
Right longchair

9NH103
L220 P115 H76,5



Noah Bed _2022_ DESIGN LUCA ERBA

Struttura costituita da pannelli composti da particelle di legno, principalmente pioppo e abete.
 Imbottitura in poliuretano indeformabile rivestito in dacron.
 Rete con struttura in tubo di ferro e doghe in faggio.
 Disponibile in tre diverse larghezze, anche con vano contenitore sotto la rete del letto.
 Rivestimento sfoderabile in tessuto, non sfoderabile in pelle e finta pelle.

Structure composée de panneaux composés de particules de bois, principalement de peuplier et de sapin.
 Rembourrage en polyuréthane indéformable recouvert de dacron.
 Sommier avec structure en tube de fer et lattes de hêtre.
 Disponible en trois largeurs différentes, également avec compartiment de rangement sous le sommier.
 Revêtement déhoussable en tissu, non déhoussable en cuir et simili cuir.

Structure consisting of panels composed of wood particles, mainly poplar and fir.
 Padding in non-deformable polyurethane covered in dacron.
 Bed base with structure in iron tube and beech slats.
 Available in three different widths, also with storage compartment under the bed base.
 Removable cover in fabric, non-removable in leather and artificial leather.

Конструкция состоит из панелей из древесных частиц, в основном тополя и ели.
 Набивка из недеформируемого полиуретана, покрытого лавсаном.
 Основание кровати с конструкцией из железной трубы и буковыми планками.
 Доступен в трех вариантах ширины, а также с отделением для хранения под основанием кровати.
 Съёмный чехол из ткани, несъёмный чехол из кожи и искусственной кожи.

Struktur bestehend aus Platten aus Holzpartikeln, hauptsächlich Pappel und Tanne.
 Polsterung aus unverformbarem, mit Dacron überzogenem Polyurethan.
 Lattenrost mit Struktur aus Eisenrohr und Buchenlatten.
 Erhältlich in drei verschiedenen Breiten, auch mit Bettkasten unter dem Lattenrost.
 Abnehmbarer Bezug aus Stoff, nicht abziehbar aus Leder und Kunstleder.

Letti Beds

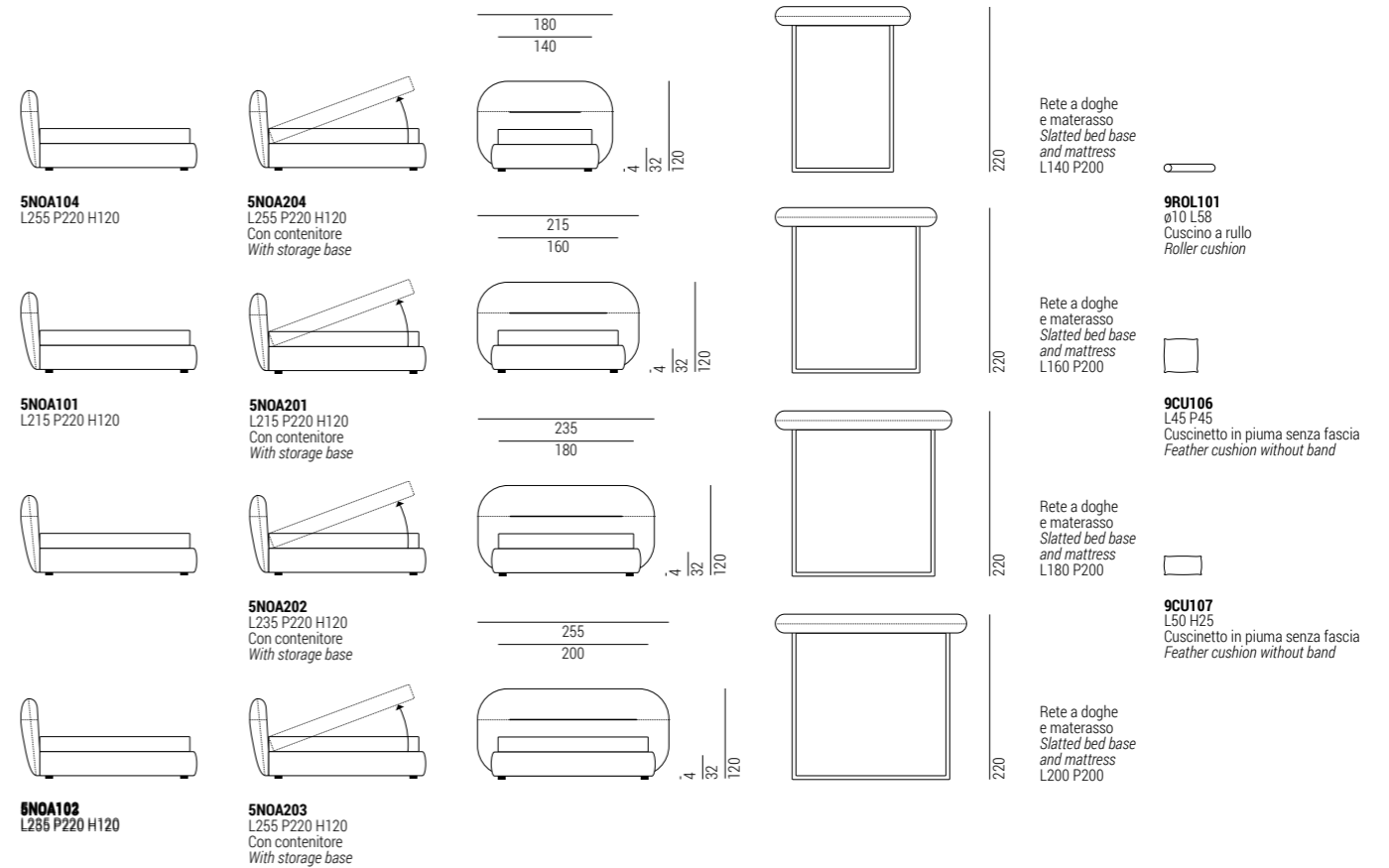

Cuscini Cushions

Onno _ 2022 _ DESIGN LUCA ERBA

Tavoli Dining tables

Il tavolo da pranzo Onno è disponibile con top in marmo e base in due versioni:
 - base impiallacciato rovere tinto nelle finiture rovere in collezione
 - base in MDF verniciato finiture metallo o verniciato nei colori RAL Classic
 Onno dining table is available with marble top and base in two versions:
 - oak veneer base stained in the oak finishes in collection
 - base in MDF painted in metal finishes or painted in the RAL Classic colours

Top: marmo, spessore 20 mm
Top: marble, 20 mm thick

70N203 Top marmo/Marble top
Base in rovere/Oak base
70N204 Top marmo/Marble top
Base in MDF/MDF base
L220 P120 H74

70N205 Top marmo/Marble top
Base in rovere/Oak base
70N206 Top marmo/Marble top
Base in MDF/MDF base
L240 P120 H74

70N201 Top marmo/Marble top
Base in rovere/Oak base
70N202 Top marmo/Marble top
Base in MDF/MDF base
L260 P120 H74

70N207 Top marmo/Marble top
Base in rovere/Oak base
70N208 Top marmo/Marble top
Base in MDF/MDF base
ø160 H74

70N209 Top marmo/Marble top
Base in rovere/Oak base
70N210 Top marmo/Marble top
Base in MDF/MDF base
L450 P120 H74

Tavolini Coffee tables

70N105 Top marmo/Marble top
Base in rovere/Oak base
L120 P120 H25

70N106 Top marmo/Marble top
Base in rovere/Oak base
ø120 H25

70N109 Top marmo/Marble top
Base in rovere/Oak base
L90 P90 H25

70N110 Top marmo/Marble top
Base in rovere/Oak base
ø90 H25

70N107 Top marmo/Marble top
Base in rovere/Oak base
L150 P60 H25

70N108 Top marmo/Marble top
Base in rovere/Oak base
L150 P60 H25

70N113 Top marmo/Marble top
Base in rovere/Oak base
L120 P120 H35

70N114 Top marmo/Marble top
Base in rovere/Oak base
ø120 H35

70N111 Top marmo/Marble top
Base in rovere/Oak base
L90 P90 H35

70N112 Top marmo/Marble top
Base in rovere/Oak base
ø90 H35

70N115 Top marmo/Marble top
Base in rovere/Oak base
L150 P60 H35

70N116 Top marmo/Marble top
Base in rovere/Oak base
L150 P60 H35

70N101 Top marmo/Marble top
Base in rovere/Oak base
L60 P60 H35

70N102 Top marmo/Marble top
Base in rovere/Oak base
ø60 H35

70N103 Top marmo/Marble top
Base in rovere/Oak base
L45 P45 H45

70N104 Top marmo/Marble top
Base in rovere/Oak base
ø45 H45

70N303 Top marmo/Marble top
Base in rovere/Oak base
ø50 H50

70N301 L200 P38 H198

70N302 L160 P55 H74

Comodino
Bedside table

Libreria
Bookshelf

Consolle
Console

Onno _ 2022 _ DESIGN LUCA ERBA

Finiture Finishes

Top in marmo Marble top										
Code	White Carrara marble OPP1	Black Marquina marble OPP2	Brown Emperador marble OPP3	Grey Serena stone OPP4	Beige Brera stone OPP5	Calacatta marble OPP7	Black and gold marble OPP9	Perfetto brown marble OPP10	Grey Stone marble OPP11	Guatemala green marble OPP12
Code										
Code	Velvet brown marble OPP13	Amani Bronze marble OPP14	Covelano white marble OPP15	Sahara noir marble OPP16	Port Laurent marble OPP17	Arabescato orobico grey marble OPP20	Calacatta violet marble OPP21	Travertino marble OPP22		
Base in rovere impiallacciato Oak veneer base										
Code	Cherry stained oak OPR1	Wengé stained oak OPR2	Walnut stained oak OPR3	Natural oak OPR4	Black stained oak OPR5	Cherry Milano stained oak OPR6				
Code										
Code	Tobacco stained oak OPR8	Grey taupe stained oak OPR9	Whitened oak OPR10	Charcoal stained oak OPR11	Mahogany stained oak OPR12	Moka matt stained oak OPR15				
Base: MDF verniciato finitura metallica Base: MDF base painted in metal finishing										
Code	RAL 9017 black OPM6	RAL 9016 white OPM7	Classic bronze OPM9	Golden beach OPM10	Gold pearl OPM11	Brushed copper OPM12				
Code										
Code	Brushed antique brass OPM13	Brushed antique gold OPM15	Anodyc bronze OPM18	Delabre pewter brushed OPM19	Delabre brass brushed OPM20	Dark bronze OPM21	Prosecco painted metal OPM22	Tobacco painted metal OPM23		
Base: MDF verniciato opaco Base: MDF matt painted										
	Beige	Cammello	Ottanio	Prugna	Pesca	Ocra	Caramello			

Sign _ 2021 _ DESIGN PAOLO SALVADÈ

Schienale in legno multistrato di pioppo curvato imbottito con poliuretano espanso con densità 30 kg/m³. Seduta in legno multistrato di pioppo imbottito con poliuretano espanso 40 kg/m³, rivestito in dacron con cinghie elastiche intrecciate. Rivestimento fisso.

Dossier en bois multiplis de peuplier courbé fini de mousse de polyuréthane de densité de 30 kg/m³. Structure de l'assise en bois multiplis de peuplier finie de mousse de polyuréthane de densité de 40 kg/m³ couverte de dacron, muni de bandes élastiques entrecroisées. Revêtement fixe.

Backrest made of curved multi-ply poplar wood, upholstered with polyurethane foam with density 30 kg/m³. Seat structure made of multi-ply poplar wood, upholstered with polyurethane foam with density of 40 kg/m³, covered with dacron, with interwoven elastic belts. Fixed covers.

Для изготовления спинки используется гнутая многослойная фанера из тополя с наполнением из вспененного полиуретана плотностью 30 кг/м³. Конструкция сиденья: многослойная фанера из тополя с наполнением из вспененного полиуретана плотностью 40 кг/м³, обернутого в дакрон, в сочетании с перекрещивающимися эластичными ремнями. Обивка несъемная.

Rückenlehne aus aus gebogenem Pappelschichtholz, gepolstert mit Polyurethan-Schaumstoff mit Dichte 30 Kg/m³. Sitzstruktur aus Pappelschichtholz, gepolstert mit Polyurethan-Schaumstoff mit Dichte 40 Kg/m³, mit Dacron ummantelt, mit geflochtenen Gummigurten. Sign ist immer festbezogen.

Sign _ 2021 _ DESIGN PAOLO SALVADÈ

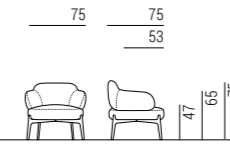

Divani Sofas



9SI101
Poltrona girevole/Swivel armchair
L83 P75 H75



9SI112
Base in metallo/Metal base
L83 P75 H75

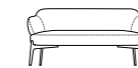

9SI211
Base in metallo/Metal base
L160 P75 H75

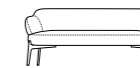

9SI212
Base in metallo/Metal base
L180 P75 H75



9SI102
Base in legno/Wood base
L83 P75 H75



9SI201
Base in legno/Wood base
L160 P75 H75

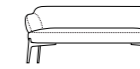

9SI202
Base in legno/Wood base
L180 P75 H75

Finiture Finishes

Base in metallo + base in metallo girevole
Metal base + swivel metal base

Code



Shiny chrome metal **OPM1**, Brushed matt chrome metal **OPM2**, Brushed matt dark grey metal **OPM3**, RAL 9017 black painted metal **OPM6**, RAL 9016 white painted metal **OPM7**, Classic bronze painted metal **OPM9**, Golden beach painted metal **OPM10**, Gold pearl painted metal **OPM11**, Brushed copper metal **OPM12**, Brushed antique brass metal **OPM13**

Code



Shiny black chrome metal **OPM14**, Brushed antique gold metal **OPM15**, Shiny brass chrome metal **OPM16**, Bronze metal **OPM17**, Anodyc bronze metal **OPM18**, Delabre pewter brushed metal **OPM19**, Delabre brass brushed metal **OPM20**, Dark bronze painted metal **OPM21**, Prosecco painted metal **OPM22**, Tobacco painted metal **OPM23**

Base in legno
Wooden base

Code



Cherry stained oak **OPR1**, Wengé stained oak **OPR2**, Walnut stained oak **OPR3**, Natural oak **OPR4**, Black stained oak **OPR5**, Cherry Milano stained oak **OPR6**

Code



Tobacco stained oak **OPR8**, Grey taupe stained oak **OPR9**, Whitened oak **OPR10**, Charcoal stained oak **OPR11**, Mahogany stained oak **OPR12**, Moka matt stained oak **OPR15**







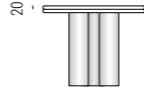

























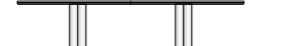

Simmy _ 2024 _ DESIGN LUCA ERBA

Tavoli Tables

Top: marmo, spessore 20 mm
Top: marble, 20 mm thick



20

				
				
7SIM201 Top marmo/Marble top ø60 H37	7SIM202 Top marmo/Marble top ø60 H47			
				
				
7SIM203 Top marmo/Marble top ø90 H27	7SIM204 Top marmo/Marble top ø90 H37	7SIM205 Top marmo/Marble top ø120 H27	7SIM206 Top marmo/Marble top ø140 H27	
				
				
7SIM207 Top marmo/Marble top L120 P70 H27	7SIM208 Top marmo/Marble top L180 P100 H27	7SIM209 Top marmo/Marble top L100 P100 H27	7SIM210 Top marmo/Marble top L120 P120 H27	7SIM211 Top marmo/Marble top L140 P140 H27
				
				
7SIM305 Top marmo/Marble top L110 P220 H74	7SIM306 Top marmo/Marble top L110 P260 H74	7SIM307 Top marmo/Marble top L110 P300 H74		
				
				
7SIM301 Top marmo/Marble top ø140 H74	7SIM302 Top marmo/Marble top ø160 H74	7SIM303 Top marmo/Marble top ø180 H74	7SIM304 Top marmo/Marble top L180 P180 H74	

Simmy _ 2024 _ DESIGN LUCA ERBA















Finiture Finishes

Top superiore in marmo
Marble upper top









Code Travertino marble **OPP22**

Top inferiore:
MDF verniciato
finitura metallica
Lower top:
MDF base painted in metal finishing

							
Code RAL 9017 black OPM6	Code RAL 9016 white OPM7	Code Classic bronze OPM9	Code Golden beach OPM10	Code Gold pearl OPM11	Code Brushed copper OPM12		
							
Code Brushed antique brass OPM13	Code Brushed antique gold OPM15	Code Anodized bronze OPM18	Code Delabre pewter brushed OPM19	Code Delabre brass brushed OPM20	Code Dark bronze OPM21	Code Prosecco painted metal OPM22	Code Tobacco painted metal OPM23

Top inferiore:
MDF verniciato lucido
Lower top:
MDF Shiny painted

						
Beige	Cammello	Ottanio	Prugna	Pesca	Ocra	Caramello

Base in marmo
Marble base



Code Travertino marble **OPP22**

Theo _2023_ DESIGN LUCA ERBA

Madia Sideboard

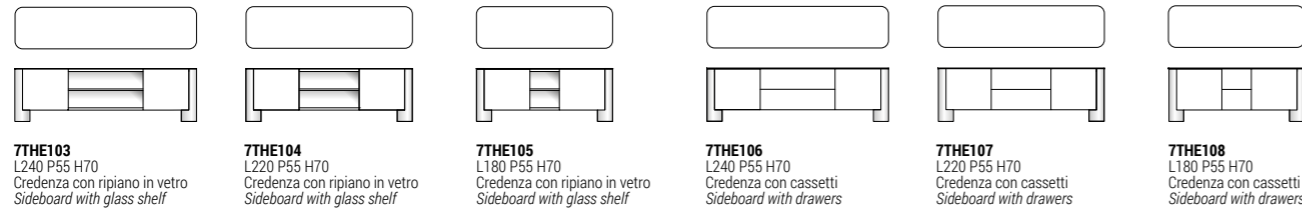

7THE103 L240 P55 H70
Credenza con ripiano in vetro
Sideboard with glass shelf

7THE104 L220 P55 H70
Credenza con ripiano in vetro
Sideboard with glass shelf

7THE105 L180 P55 H70
Credenza con ripiano in vetro
Sideboard with glass shelf

7THE106 L240 P55 H70
Credenza con cassetti
Sideboard with drawers

7THE107 L220 P55 H70
Credenza con cassetti
Sideboard with drawers

7THE108 L180 P55 H70
Credenza con cassetti
Sideboard with drawers

Finiture Finishes

Struttura madia Sideboard structure															
Code	Cherry stained oak OPR1	Wengé stained oak OPR2	Walnut stained oak OPR3	Natural oak OPR4	Black stained oak OPR5	Cherry Milano stained oak OPR6									
Code	Tobacco stained oak OPR8	Grey taupe stained oak OPR9	Whitened oak OPR10	Charcoal stained oak OPR11	Mahogany stained oak OPR12	Moka matt stained oak OPR15									
Top in marmo Marble top															
Code	White Carrara marble OPP1	Black Marquinia marble OPP2	Brown Emperador marble OPP3	Grey Serena stone OPP4	Beige Brera stone OPP5	Calacatta marble OPP7	Black and gold marble OPP9	Perfetto brown marble OPP10	Grey Stone marble OPP11	Guatemala green marble OPP12					
Code	Velvet brown marble OPP13	Amani Bronze marble OPP14	Covelano white marble OPP15	Sahara noir marble OPP16	Port Laurent marble OPP17	Arabescato orobico grey marble OPP20	Calacatta violet marble OPP21	Travertino marble OPP22							
Maniglie Handles															
Code	Brushed matt chrome metal OPM2	Brushed matt dark grey metal OPM3	RAL 9017 black painted metal OPM6	RAL 9016 white painted metal OPM7	Classic bronze painted metal OPM9	Golden beach painted metal OPM10	Gold pearl painted metal OPM11	Brushed antique brass metal OPM12	Brushed antique gold metal OPM13	Anodyc bronze metal OPM18	Delabre pewter brushed metal OPM19	Delabre brass brushed metal OPM20	Dark bronze metal OPM21	Prosecco painted metal OPM22	Tobacco painted metal OPM23
Code	Brushed antique gold metal OPM15	Anodyc bronze metal OPM18	Delabre pewter brushed metal OPM19	Delabre brass brushed metal OPM20	Dark bronze painted metal OPM21	Prosecco painted metal OPM22	Tobacco painted metal OPM23								

Theo Mirror_2023_ DESIGN LUCA ERBA

Specchi Mirror

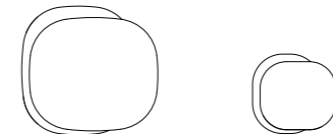

7THE102 L180 P4,5 H170











7THE101 L110 P4,5 H105

Finiture Finishes

Cornice specchio MDF verniciato finitura metallica Mirror frame MDF painted in metal finishing								
Code	RAL 9017 black OPM6	RAL 9016 white OPM7	Classic bronze OPM9	Golden beach OPM10	Gold pearl OPM11	Brushed copper OPM12		
Code	Brushed antique brass OPM13	Brushed antique gold OPM15	Anodyc bronze OPM18	Delabre pewter brushed OPM19	Delabre brass brushed OPM20	Dark bronze OPM21	Prosecco painted metal OPM22	Tobacco painted metal OPM23
Cornice specchio MDF verniciato opaco Mirror frame MDF matt painted								
	Beige	Cammello	Ottanio	Prugna	Pesca	Ocra	Caramello	









































Thor _2018_DESIGN STUDIO MARELLI

Tavoli
Tables

					
7TH101 Tavolo in marmo / Marble table 7TH201 Tavolo in finitura metallo OPM19/OPM20 Table in metal finish OPM19/OPM20 L80 P80 H19	7TH102 Tavolo in marmo Marble table 7TH202 Tavolo in finitura metallo OPM19/OPM20 Table in metal finish OPM19/OPM20 L100 P100 H19	7TH111 Tavolo in marmo con base metallo Marble table with metal base 7TH211 Tavolo in finitura metallo OPM19/OPM20 Table in metal finish OPM19/OPM20 L80 P80 H27	7TH112 Tavolo in marmo con base metallo Marble table with metal base 7TH212 Tavolo in finitura metallo OPM19/OPM20 Table in metal finish OPM19/OPM20 L100 P100 H27		
					
7TH103 Tavolo in marmo Marble table 7TH203 Tavolo in finitura metallo OPM19/OPM20 Table in metal finish OPM19/OPM20 L40 P40 H40	7TH104 Tavolo in marmo Marble table 7TH204 Tavolo in finitura metallo OPM19/OPM20 Table in metal finish OPM19/OPM20 L50 P50 H50	7TH105 Tavolo in marmo Marble table 7TH205 Tavolo in finitura metallo OPM19/OPM20 Table in metal finish OPM19/OPM20 L60 P60 H19	7TH115 Tavolo in marmo con base metallo Marble table with metal base 7TH215 Tavolo in finitura metallo OPM19/OPM20 Table in metal finish OPM19/OPM20 L60 P60 H27	7TH106 Tavolo in marmo Marble table 7TH206 Tavolo in finitura metallo OPM19/OPM20 Table in metal finish OPM19/OPM20 L60 P110 H19	7TH116 Tavolo in marmo con base metallo Marble table with metal base 7TH216 Tavolo in finitura metallo OPM19/OPM20 Table in metal finish OPM19/OPM20 L60 P110 H27











Thor _2018_DESIGN STUDIO MARELLI

Finiture
Finishes

Marmo Marble										
Code	White Carrara marble OPP1	Black Marquina marble OPP2	Brown Emperador marble OPP3	Grey Serena stone OPP4	Beige Brera stone OPP5	Calacatta marble OPP7	Black and gold marble OPP9	Perfetto brown marble OPP10	Grey Stone marble OPP11	Guatemala green marble OPP12
										
Code	Velvet brown marble OPP13	Amani Bronze marble OPP14	Covelano white marble OPP15	Sahara noir marble OPP16	Port Laurent marble OPP17	Arabescato orobico grey marble OPP20	Calacatta violet marble OPP21	Travertino marble OPP22		
Base in metallo Metal base										
Code	Shiny chrome metal OPM1	Brushed matt chrome metal OPM2	Brushed matt dark grey metal OPM3	RAL 9017 black painted metal OPM6	RAL 9016 white painted metal OPM7	Classic bronze painted metal OPM9	Golden beach painted metal OPM10	Gold pearl painted metal OPM11	Brushed copper metal OPM12	Brushed antique brass metal OPM13
										
Code	Shiny black chrome metal OPM14	Brushed antique gold metal OPM15	Shiny brass chrome metal OPM16	Bronze metal OPM17	Anodyc bronze metal OPM18	Delabre pewter brushed metal OPM19	Delabre brass brushed metal OPM20	Dark bronze painted metal OPM21	Prosecco painted metal OPM22	Tobacco painted metal OPM23
Tavolo in finitura metallo Table in metal finish										
Code	Delabre pewter brushed metal OPM19	Delabre brass brushed metal OPM20								

Wave _2021 _ DESIGN LUCA ERBA

Tavoli Tables

		
		
<p>7WA101 Top marmo/Marble top 7WA111 Top vetro/Glass top 7WA121 Top metallo/Metal top ø50 H47</p>	<p>7WA102 Top marmo/Marble top 7WA112 Top vetro/Glass top 7WA122 Top metallo/Metal top ø60 H37</p>	<p>7WA105 Top marmo/Marble top 7WA115 Top vetro/Glass top 7WA125 Top metallo/Metal top ø100x37h</p>
		
		
<p>7WA103 Top marmo/Marble top 7WA113 Top vetro/Glass top 7WA123 Top metallo/Metal top ø100 H27</p>	<p>7WA104 Top marmo/Marble top 7WA114 Top vetro/Glass top 7WA124 Top metallo/Metal top ø120 H27</p>	

Top: rovere impiallacciato o marmo, spessore 20 mm
Base: tubo di metallo quadrato, sezione 15 mm
Top: oak veneer or marble, 20 mm thick
Base: square metal tube, section 15 mm

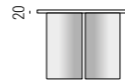



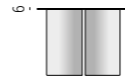





































Top in vetro extralight temperato, spessore 6 mm
Base: tubo di metallo quadrato, sezione 15 mm
Top: extralight tempered glass, 6 mm thick
Base: square metal tube, section 15 mm



Wave _2021 _ DESIGN LUCA ERBA

Finiture Finishes

Top in marmo Marble top										
Code	White Carrara marble OPP1	Black Marquina marble OPP2	Brown Emperador marble OPP3	Grey Serena stone OPP4	Beige Brera stone OPP5	Calacatta marble OPP7	Black and gold marble OPP9	Perfetto brown marble OPP10	Grey Stone marble OPP11	Guatemala green marble OPP12
Top in marmo Marble top										
Code	Velvet brown marble OPP13	Amani Bronze marble OPP14	Covelano white marble OPP15	Sahara noir marble OPP16	Port Laurent marble OPP17	Arabescato orobico grey marble OPP20	Calacatta violet marble OPP21	Travertino OPP22		
Top in Gres Porcellanato Porcelain Stoneware Top										
Code	Nero Marquina OPG2	Statuario Supremo OPG6								
Top in vetro Glass top										
Code	RAL 9016 traffic white back-painted glass OPV3	RAL 9017 traffic black back-painted glass OPV4	RAL 7044 silk grey back-painted glass OPV5	RAL 1019 grey beige back-painted glass OPV6	Chrome back-painted bronze glass OPV9	Chrome back-painted grey glass OPV10				
Base in metallo Metal Base										
Code	Brushed matt chrome metal OPM2	Brushed matt dark grey metal OPM3	RAL 9017 black painted metal OPM6	RAL 9016 white painted metal OPM7	Classic bronze painted metal OPM9	Golden beach painted metal OPM10	Gold pearl painted metal OPM11	Brushed copper metal OPM12		
Code										
Code	Brushed antique brass metal OPM13	Brushed antique gold metal OPM15	Delabre pewter brushed metal OPM19	Delabre brass brushed metal OPM20	Dark bronze painted metal OPM21	Prosecco painted metal OPM22	Tobacco painted metal OPM23			

Wave Dining Table _2022_ DESIGN LUCA ERBA

Tavoli
Tables

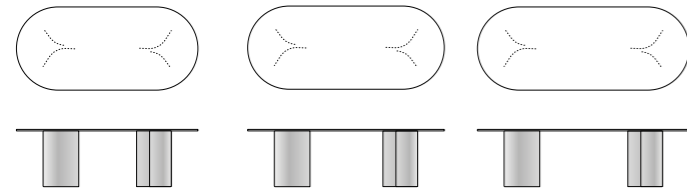

7WA202
Top marmo/Marble top
7WA212
Top vetro/Glass top
7WA222
Top legno/Wooden top
L240 P110 H74

7WA201
Top marmo/Marble top
7WA211
Top vetro/Glass top
7WA221
Top legno/Wooden top
L260 P110 H74

7WA203
Top marmo/Marble top
7WA213
Top vetro/Glass top
7WA223
Top legno/Wooden top
L280 P110 H74

Top: rovere impiallacciato o marmo, spessore 20 mm
Base: tubo di metallo quadrato, sezione 15 mm
Top: oak veneer or marble, 20 mm thick
Base: square metal tube, section 15 mm



Top in vetro extralight temperato, spessore 6 mm
Base: tubo di metallo quadrato, sezione 15 mm
Top: extralight tempered glass, 6 mm thick
Base: square metal tube, section 15 mm

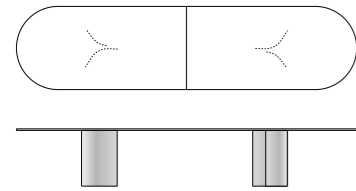

7WA205
Top marmo/Marble top
7WA225
Top legno/Wooden top
L450 P110 H74

Wave Dining Table _2022_ DESIGN LUCA ERBA

Finiture
Finishes

Top in marmo
Marble top



Code	White Carrara marble OPP1	Black Marquina marble OPP2	Brown Emperador marble OPP3	Grey Serena stone OPP4	Beige Brera stone OPP5	Calacatta marble OPP7	Black and gold marble OPP9	Perfetto brown marble OPP10	Grey Stone marble OPP11	Guatemala green marble OPP12
-------------	-------------------------------------	--------------------------------------	---------------------------------------	----------------------------------	----------------------------------	---------------------------------	--------------------------------------	---------------------------------------	-----------------------------------	--

Top in marmo
Marble top

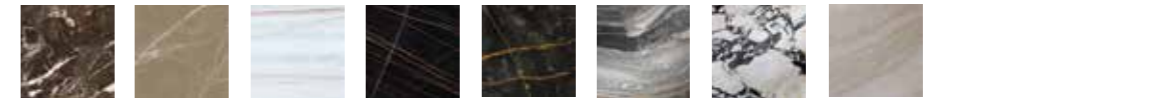

Code	Velvet brown marble OPP13	Amani Bronze marble OPP14	Covelano white marble OPP15	Sahara noir marble OPP16	Port Laurent marble OPP17	Arabescato orobico grey marble OPP20	Calacatta violet marble OPP21	Travertino marble OPP22
-------------	-------------------------------------	-------------------------------------	---------------------------------------	------------------------------------	-------------------------------------	--	---	-----------------------------------

Top in Gres Porcellanato
Porcelain Stoneware Top



Code	Nero Marquina OPG2	Statuario Supremo OPG6
-------------	------------------------------	----------------------------------

Top in vetro
Glass top



Code	RAL 9016 traffic white back-painted glass OPV3	RAL 9017 traffic black back-painted glass OPV4	RAL 7044 silk grey back-painted glass OPV5	RAL 1019 grey beige back-painted glass OPV6	Chrome back-painted bronze glass OPV9	Chrome back-painted grey glass OPV10
-------------	--	--	--	---	---	--

Base in metallo
Metal Base



Code	Brushed matt chrome metal OPM2	Brushed matt dark grey metal OPM3	RAL 9017 black painted metal OPM6	RAL 9016 white painted metal OPM7	Classic bronze painted metal OPM9	Golden beach painted metal OPM10	Gold pearl painted metal OPM11	Brushed copper metal OPM12
-------------	--	---	---	---	---	--	--	--------------------------------------



Code	Brushed antique brass metal OPM13	Brushed antique gold metal OPM15	Anodyc bronze metal OPM18	Delabre pewter brushed metal OPM19	Delabre brass brushed metal OPM20	Dark bronze painted metal OPM21	Prosecco painted metal OPM22	Tobacco painted metal OPM23
-------------	---	--	-------------------------------------	--	---	---	--	---------------------------------------

Wave Round Dining Table _2022_ DESIGN LUCA ERBA

Tavoli
Tables

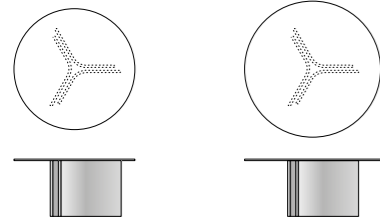

7WA204
Top marmo/Marble top
ø160 H74

7WA206
Top marmo/Marble top
ø180 H74

Top: marmo, spessore 20 mm
Base: MDF, spessore 30 mm
Top: marble, 20 mm thick
Base: MDF, thickness 30 mm

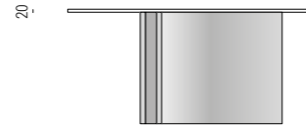

Wave Round Dining Table _2022_ DESIGN LUCA ERBA

Finiture
Finishes

Top in marmo Marble top										
Code	White Carrara marble OPP1	Black Marquina marble OPP2	Brown Emperador marble OPP3	Grey Serena stone OPP4	Beige Brera stone OPP5	Calacatta marble OPP7	Black and gold marble OPP9	Perfetto brown marble OPP10	Grey Stone marble OPP11	Guatemala green marble OPP12
Top in marmo Marble top										
Code	Velvet brown marble OPP13	Amani Bronze marble OPP14	Covelano white marble OPP15	Sahara noir marble OPP16	Port Laurent marble OPP17	Arabescato orobico grey marble OPP20	Calacatta violet marble OPP21	Travertino marble OPP22		
Top in Gres Porcellanato Porcelain Stoneware Top										
Code	Nero Marquina OPG2	Statuario Supremo OPG6								
Base: MDF verniciato finitura metallica Base: MDF base painted in metal finishing										
Code	RAL 9017 black OPM6	RAL 9016 white OPM7	Classic bronze OPM9	Golden beach OPM10	Gold pearl OPM11	Brushed copper OPM12				
Code	Brushed antique brass OPM13	Brushed antique gold OPM15	Anodyc bronze OPM18	Delabre pewter brushed OPM19	Delabre brass brushed OPM20	Dark bronze OPM21	Prosecco painted metal OPM22	Tobacco painted metal OPM23		
Base: MDF verniciato opaco Base: MDF matt painted										
	Beige	Cammello	Ottanio	Prugna	Pesca	Ocra	Caramello			

Yann _2023_ _DESIGN LUCA ERBA

Fusto in legno massello e legno multistrato con cinghie elastiche intrecciate.
 Imbottitura in poliuretano espanso con densità 40 Kg/m³ rivestito in dacron.
 Seduta e schienale in poliuretano espanso con densità di 30 Kg/m³, rivestito in dacron.
 Cuscini di schienale in piuma.
 Rivestimento sfoderabile in tessuto, non sfoderabile in pelle e finta pelle.
 Kit letto non disponibile.

*Carcasse en bois massif et multiplis muni de bandes élastiques entrecroisées et finie de mousse de polyuréthane d'une densité de 40 kg/m³ couverte de dacron.
 Assise et dossier en mousse de polyuréthane d'une densité de 30 kg/m³, couverte de dacron.
 Coussins de dossier en plumes.
 Revêtement déhoussable en tissu, revêtement fixe en cuir et similcuir.
 Pas disponible en canapé-lit.*

*Frame made of solid wood and multi-ply wood with interwoven elastic straps, upholstered with polyurethane foam with density of 40 Kg/m³, covered with dacron.
 Seat and back in polyurethane foam with density of 30 Kg/m³, covered with dacron.
 Feather back cushions.
 Removable fabric covers, fixed leather and artificial leather covers.
 Sofa-bed is not available.*

*Каркас из массива дерева и фанеры с переплетенными эластичными ремнями.
 Набивка из пенополиуретана плотностью 40 кг/м³, покрытая дакроном.
 Сиденье и спинка из пенополиуретана плотностью 30 кг/м³, покрыты дакроном.
 Подушки спинки из пера.
 Съёмный чехол из ткани, несъёмный чехол из кожи и искусственной кожи.
 Комплект постели не поставляется.*

*Das Gestell besteht aus Massiv- und Schichtholz, mit geflochtenen Gummigurten, gepolstert mit Polyurethan-Schaumstoff 40 Kg/m³, mit Dacron ummantelt.
 Sitz und Rücken bestehen aus Polyurethan-Schaumstoff 30 Kg/m³, mit Dacron ummantelt.
 Rückenkissen in Daune.
 Abziehbare Stoffbezüge, feste Leder- und Kunstlederbezüge.
 Als Bettsofa nicht verfügbar.*

Yann _2023_ _DESIGN LUCA ERBA

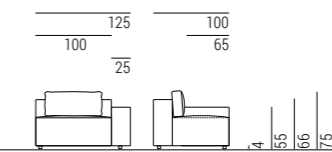
Elementi di seduta
Seat elements

9YA301
 Elemento centrale
 Central element
 L100 P100 H66



9YA205
 Laterale con bracciolo
 Side element with armrest
 L100 P100 H66



9YA501
 Elemento angolare
 Corner element
 L100 P100 H66



9YA302
 Elemento centrale
 Central element
 L125 P100 H66



9YA201
 Laterale con bracciolo
 Side element with armrest
 L125 P100 H66



9YA502
 Elemento angolare
 Corner element
 L125 P100 H66



9YA303
 Elemento centrale
 Central element
 L75 P100 H66

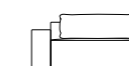
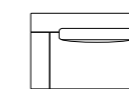

9YA202
 Laterale con bracciolo
 Side element with armrest
 L150 P100 H66

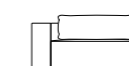
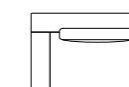

9YA503
 Elemento angolare
 Corner element
 L150 P100 H66



9YA304
 Elemento centrale
 Central element
 L100 P150 H66



9YA401
 L100 P100 H38



9YA402
 L75 P75 H38

Pouf
Ottomans

9YA401
 L100 P100 H38



9YA402
 L75 P75 H38

Yann _2023_ DESIGN LUCA ERBA

Elementi componibili Modular elements

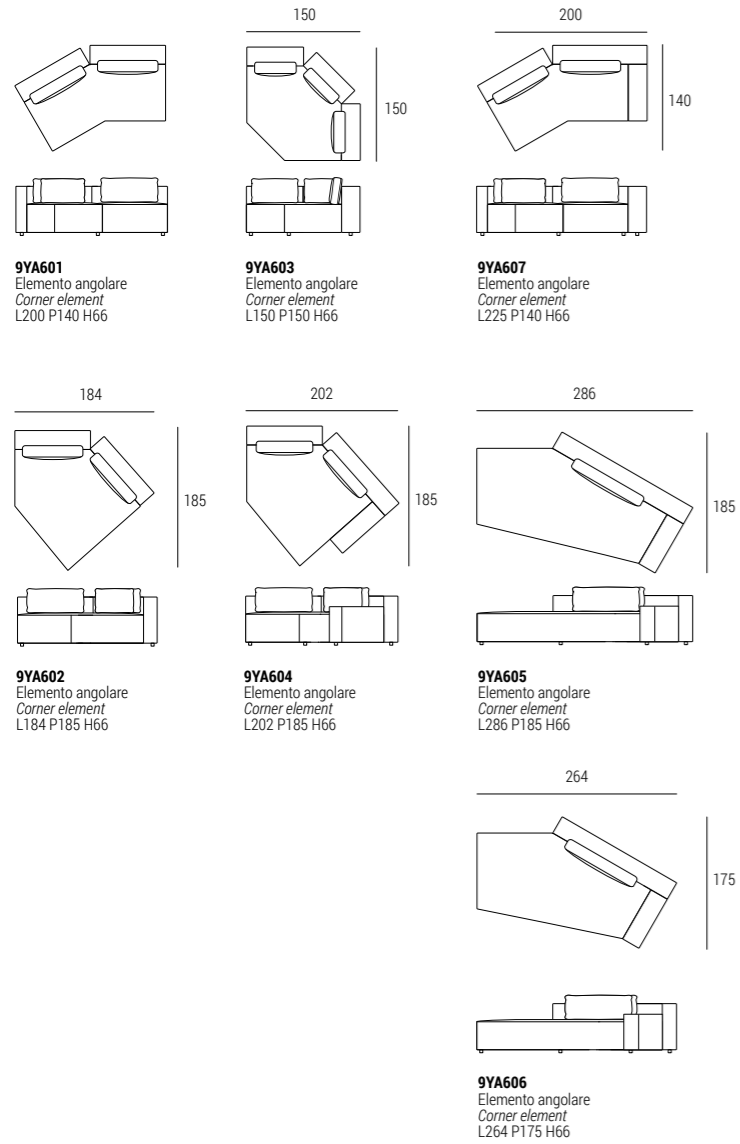

Tavolini Tables

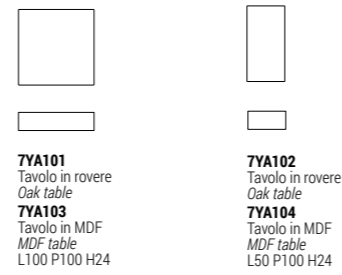

Finiture Finishes

Tavolino in rovere Oak table								
Code	Cherry stained oak OPR1	Wengé stained oak OPR2	Walnut stained oak OPR3	Natural oak OPR4	Black stained oak OPR5	Cherry Milano stained oak OPR6		
Code	Tobacco stained oak OPR8	Grey taupe stained oak OPR9	Whitened oak OPR10	Charcoal stained oak OPR11	Mahogany stained oak OPR12	Moka matt stained oak OPR15		
Tavolino in MDF verniciato finitura metallica MDF table painted in metal finishing								
Code	RAL 9017 black OPM6	RAL 9016 white OPM7	Classic bronze OPM9	Golden beach OPM10	Gold pearl OPM11	Brushed copper OPM12		
Code	Brushed antique brass OPM13	Brushed antique gold OPM15	Anodyc bronze OPM18	Delabre pewter brushed OPM19	Delabre brass brushed OPM20	Dark bronze OPM21	Prosecco painted metal OPM22	Tobacco painted metal OPM23
Tavolino in MDF verniciato opaco Matt painted MDF								
	Beige	Cammello	Ottanio	Prugna	Pesca	Ocra	Caramello	

Yann _2023_ DESIGN LUCA ERBA

graphic

Matteo Paoloni

concept and stylist creator

Morena Colombo

photoRiccardo Bianchi
IKB Studio**ringraziamenti**

Penta Light

all rights reserved © 2025

marelli**Giulio Marelli Italia SpA**Via Indipendenza 159 20821 Meda (MB) Italia
T ++39 0362 342116
info@giuliomarelli.com www.giuliomarelli.com

marelli

Giulio Marelli Italia SpA

Via Indipendenza 159 20821 Meda (MB) Italia T ++39 0362 342116
info@giuliomarelli.com www.giuliomarelli.com